

ТИПОВЫЕ КОНСТРУКЦИИ, ИЗДЕЛИЯ И УЗЛЫ ЗДАНИЙ И СООРУЖЕНИЙ

СЕРИЯ 1.020.1-4

КОНСТРУКЦИИ РАМНОГО КАРКАСА МЕЖВИДОВОГО ПРИМЕНЕНИЯ
ДЛЯ МНОГОЭТАЖНЫХ ОБЩЕСТВЕННЫХ ЗДАНИЙ, ПРОИЗВОДСТВЕННЫХ
И ВСПОМОГАТЕЛЬНЫХ ЗДАНИЙ ПРОМЫШЛЕННЫХ ПРЕДПРИЯТИЙ

выпуск 0-9

УКАЗАНИЯ ПО ПОДБОРУ ЭЛЕМЕНТОВ КАРКАСА.

(вариант армирования изделий сталью классов Ат-IVС и Врп-I).

часть 1 КНИГА 2 (стр. 57÷111)

СТР. 1÷111

ОКОНЧАНИЕ

24166 - 01

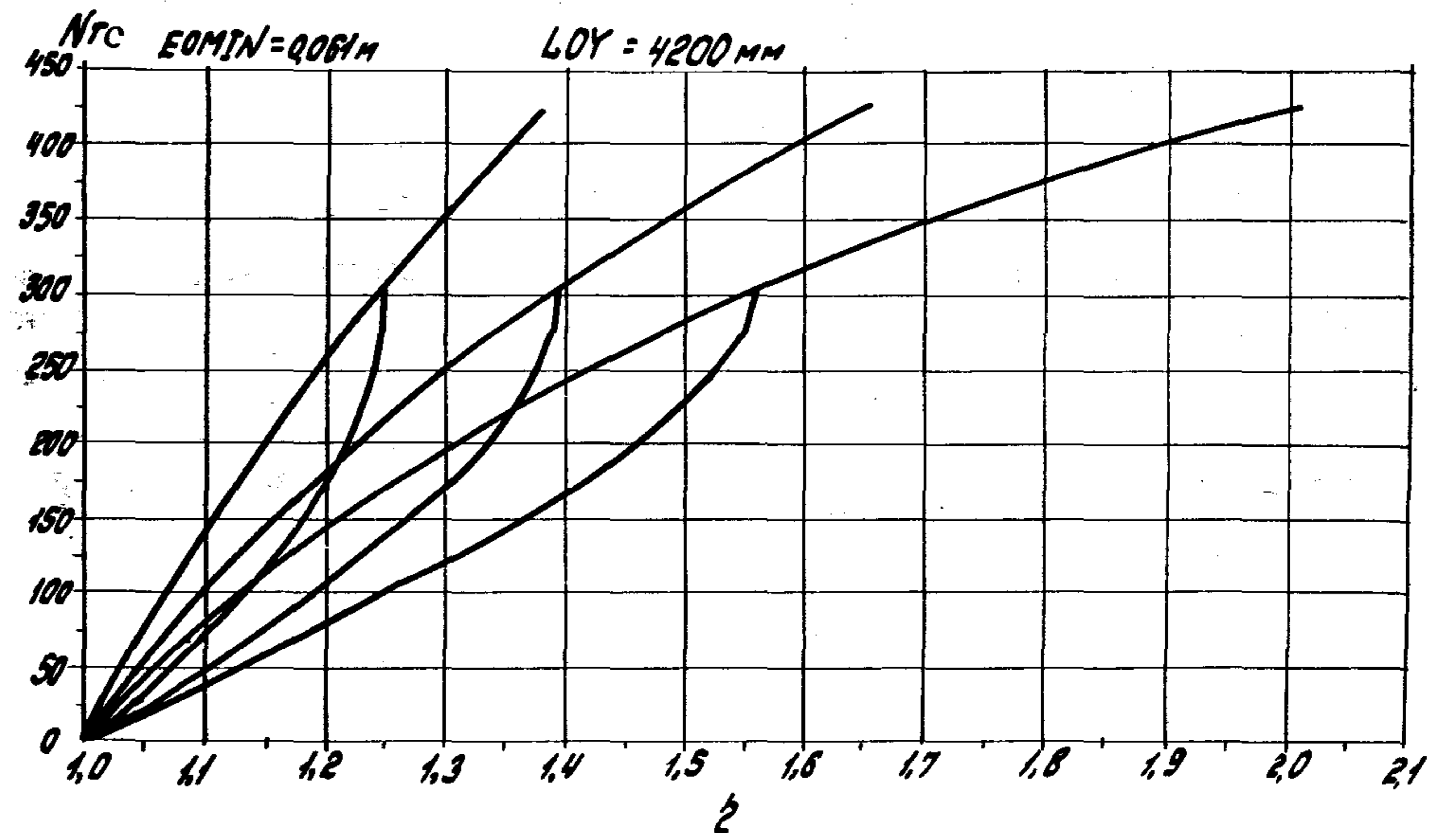
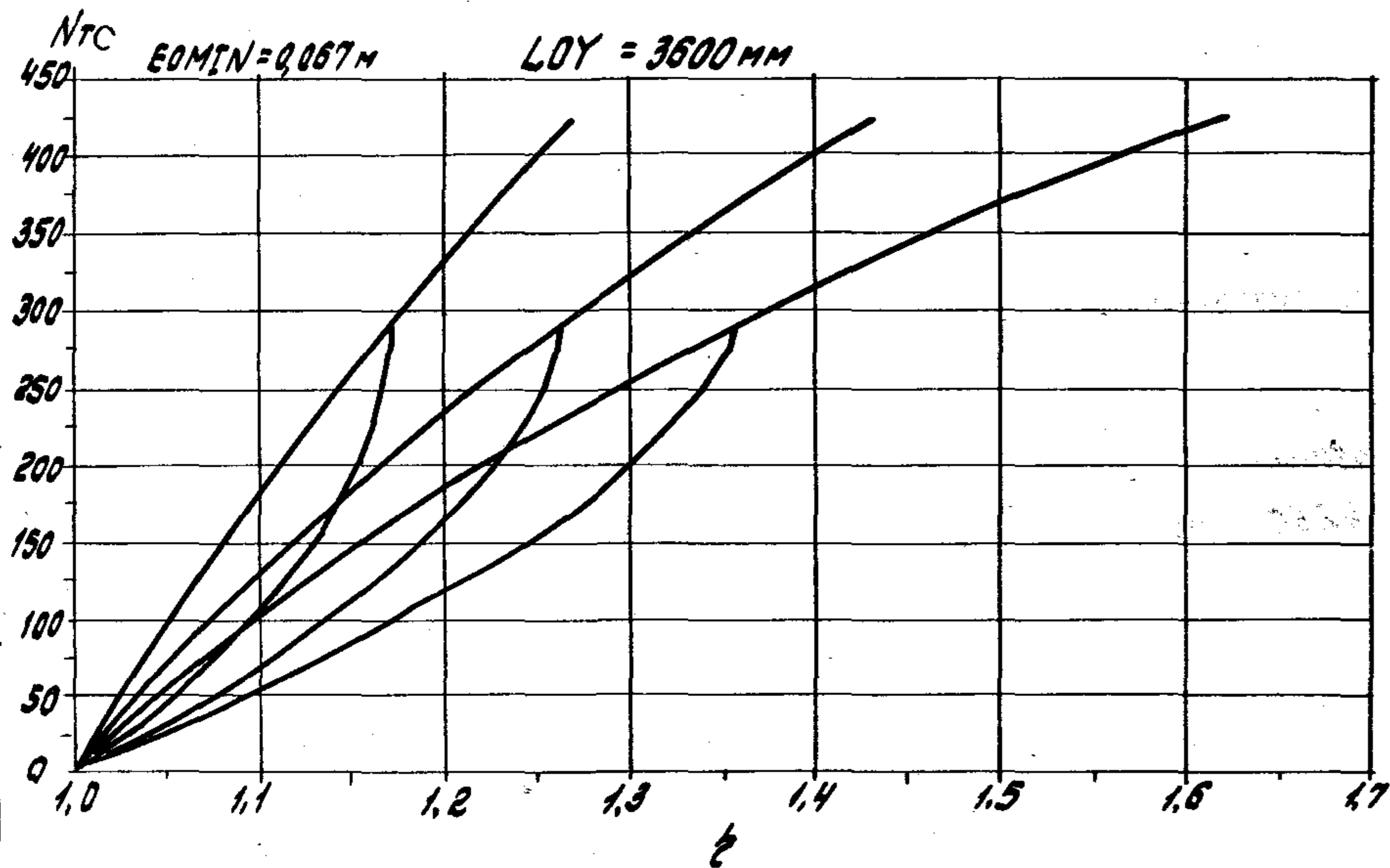
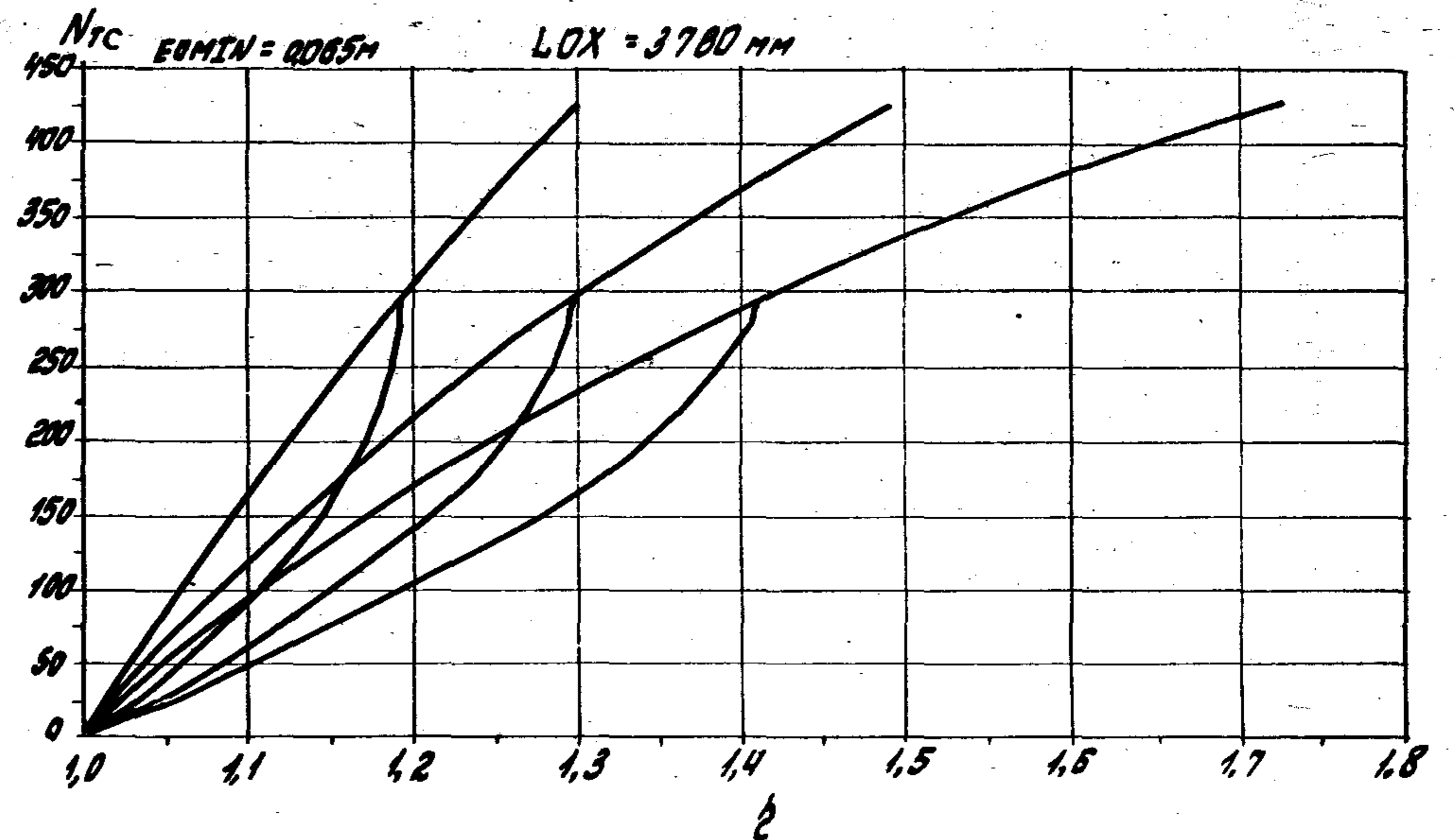
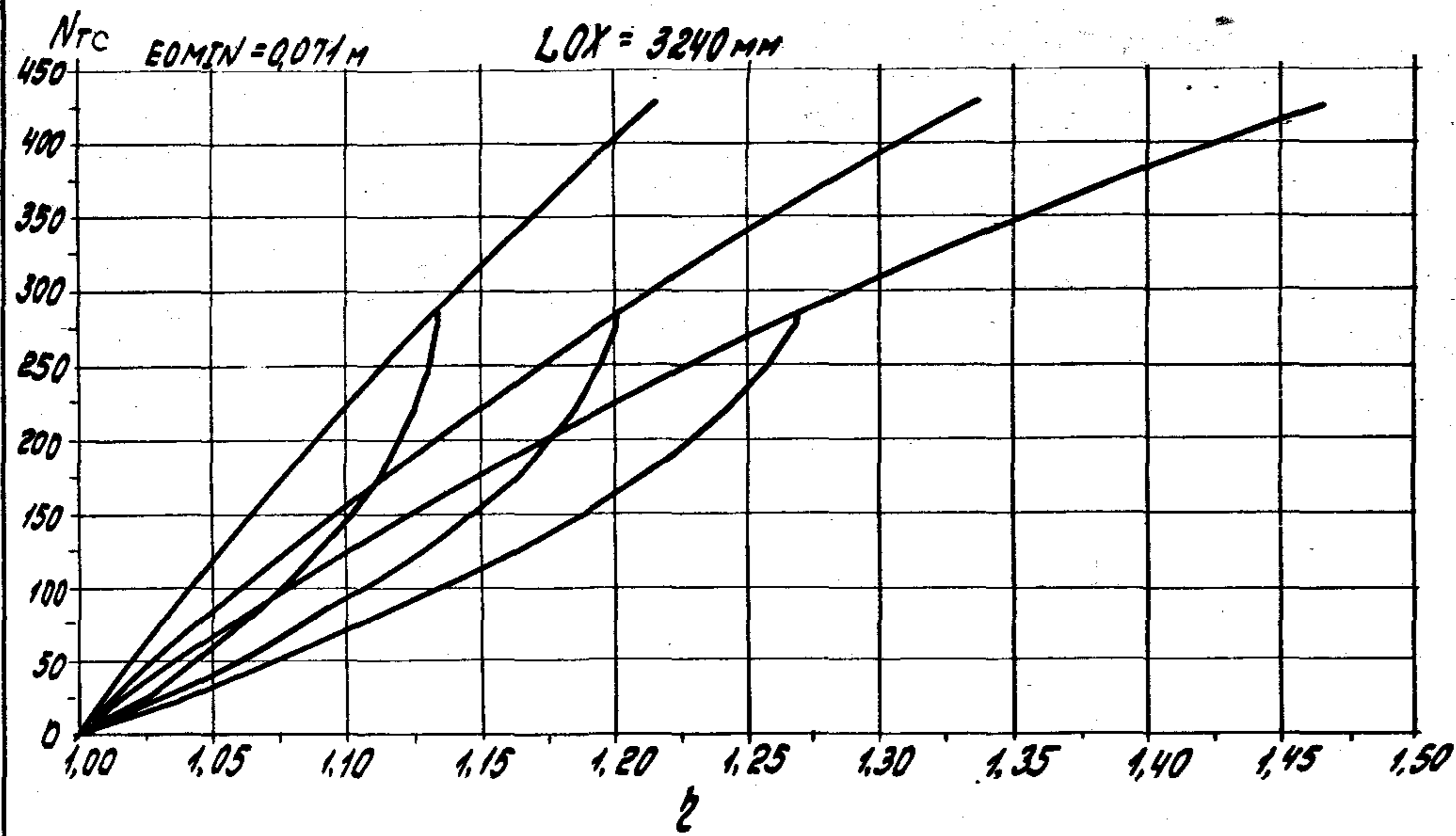

UNB-1-10-10000

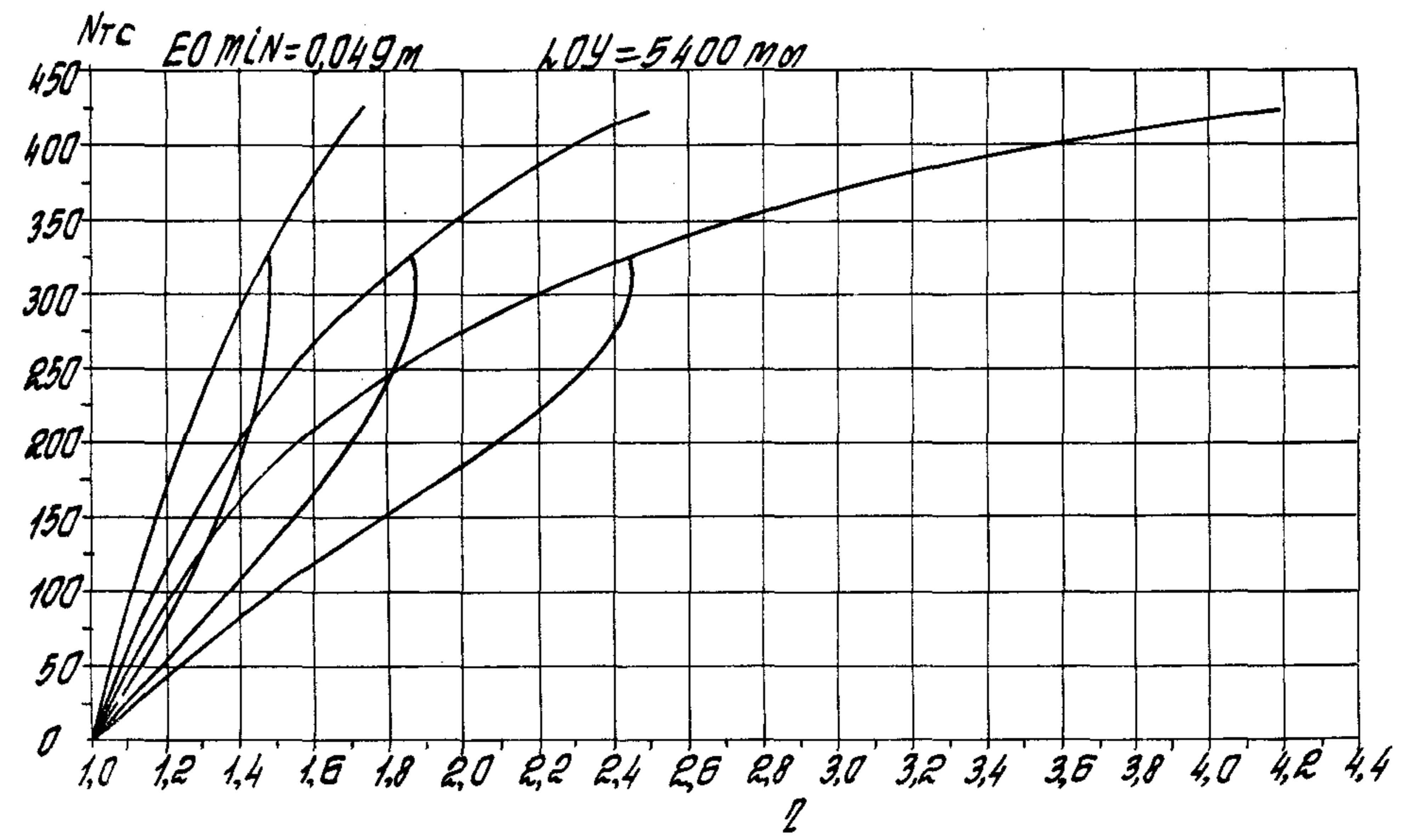
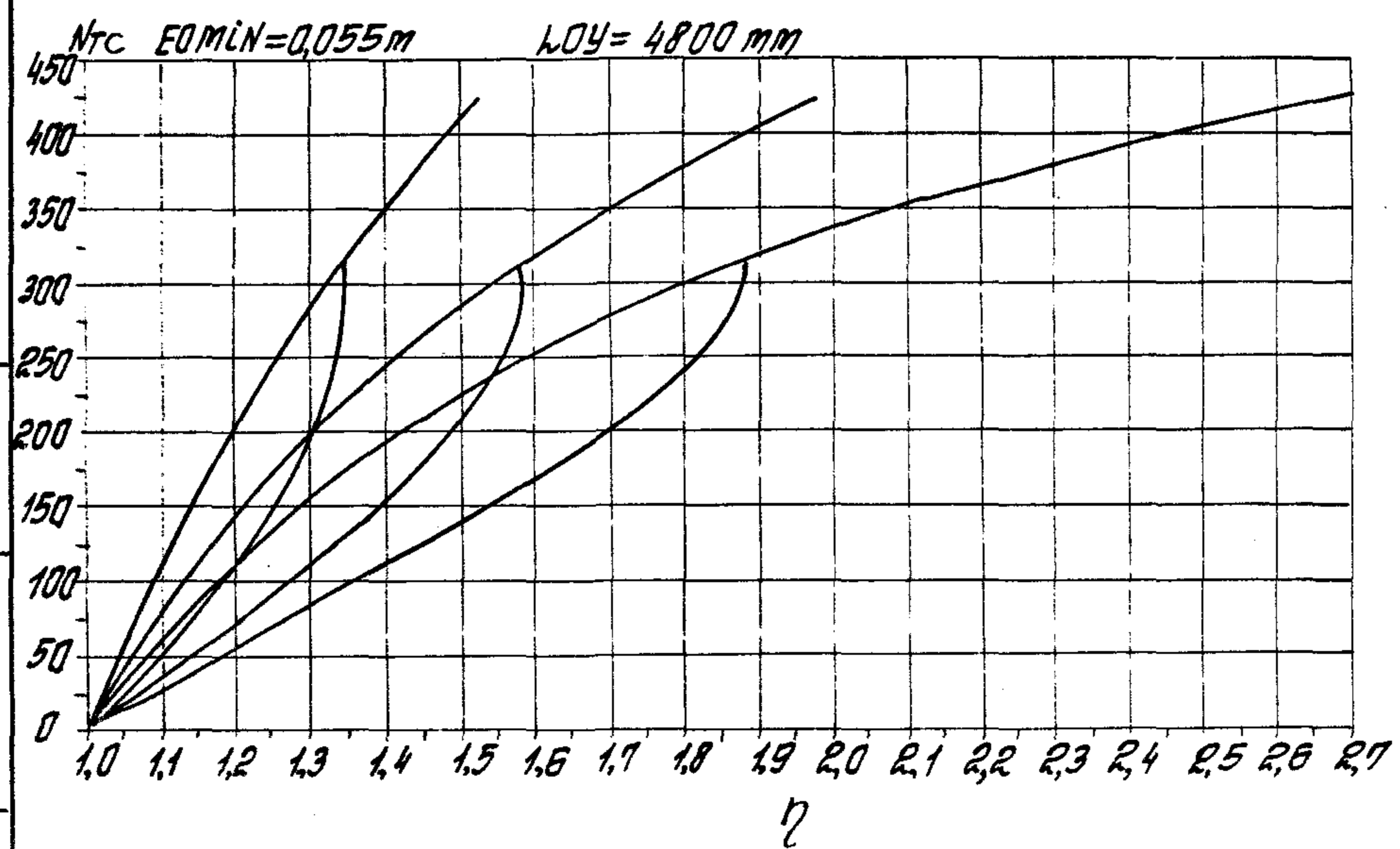
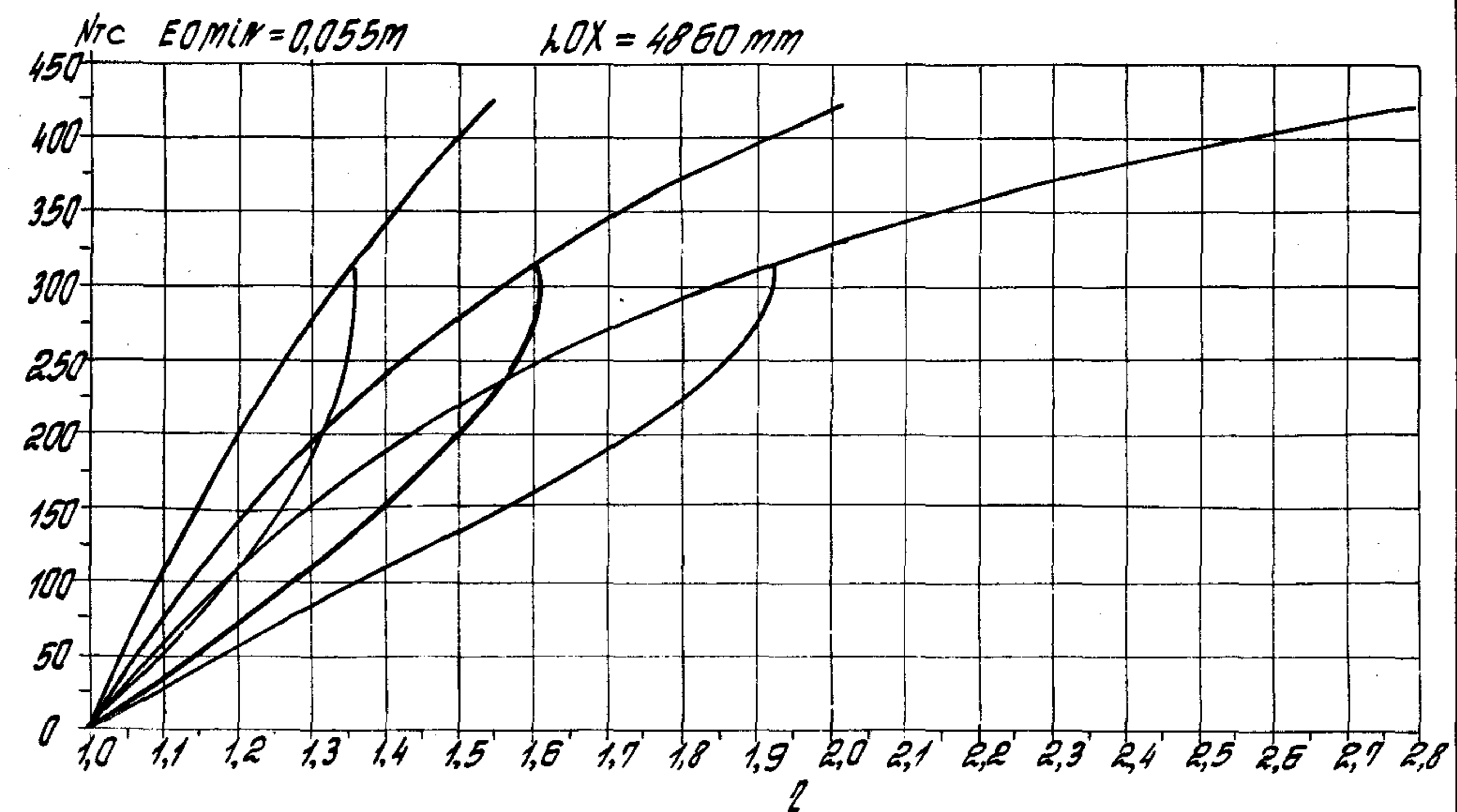
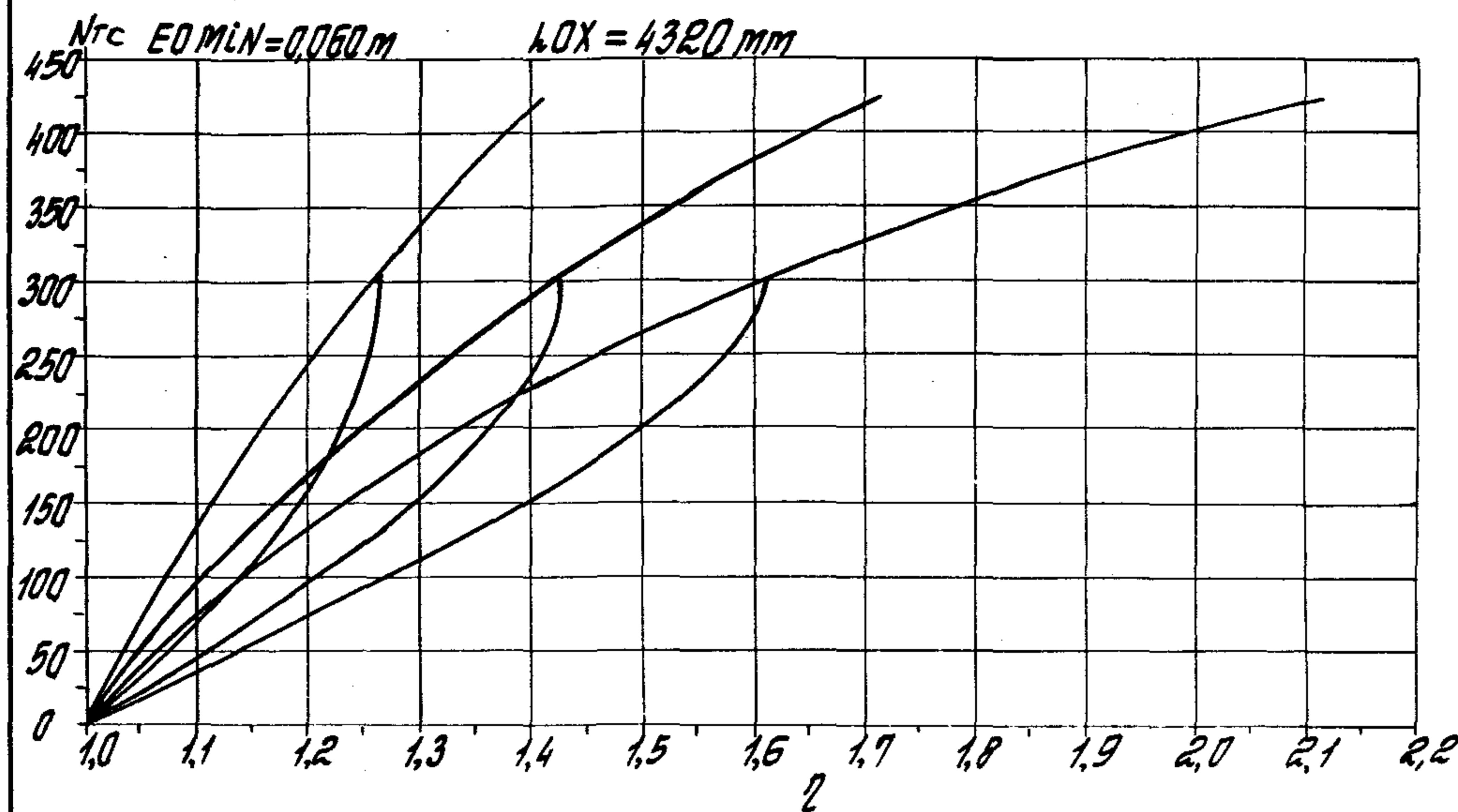

1.020.1-4 0-9 002

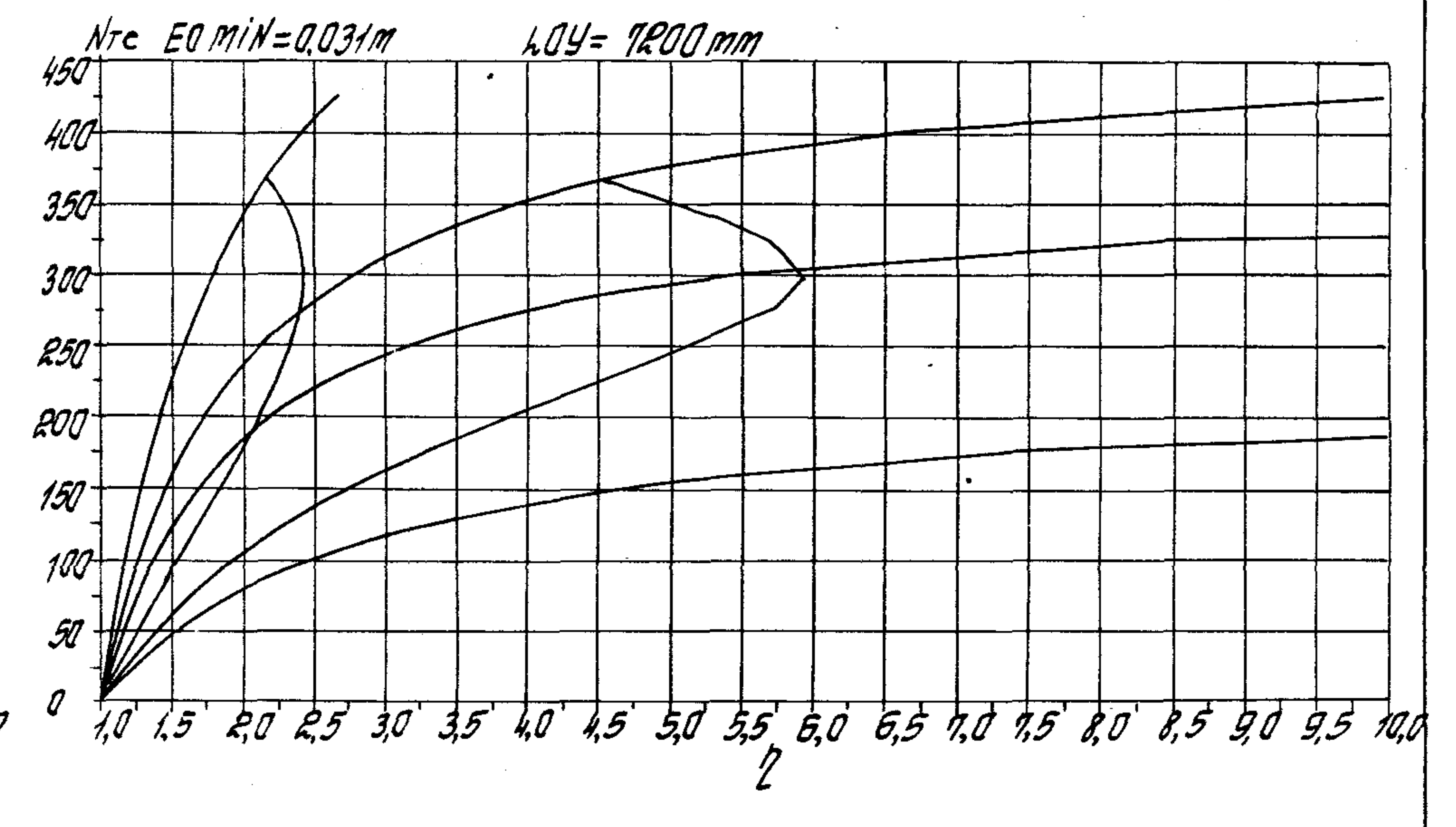
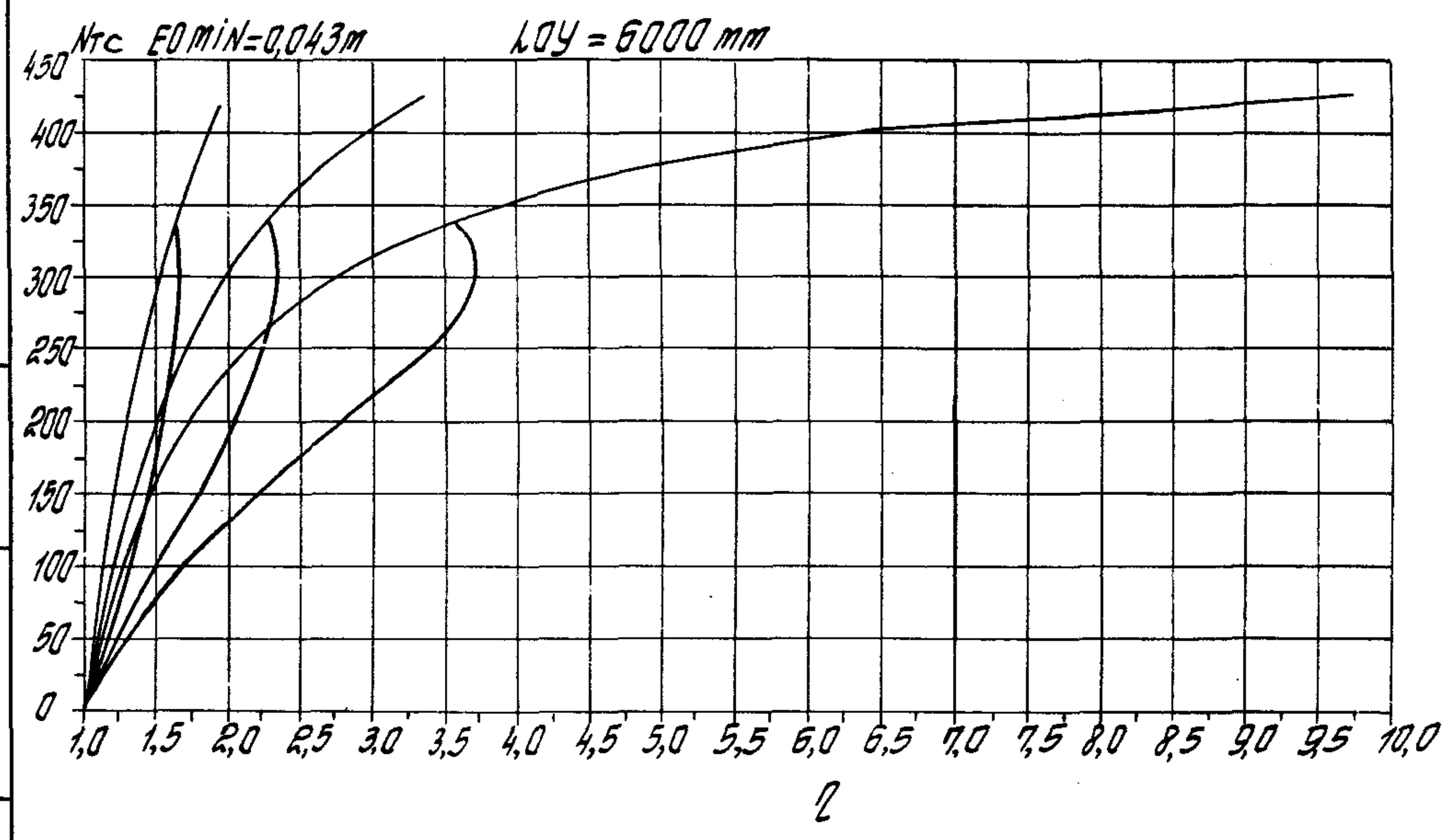
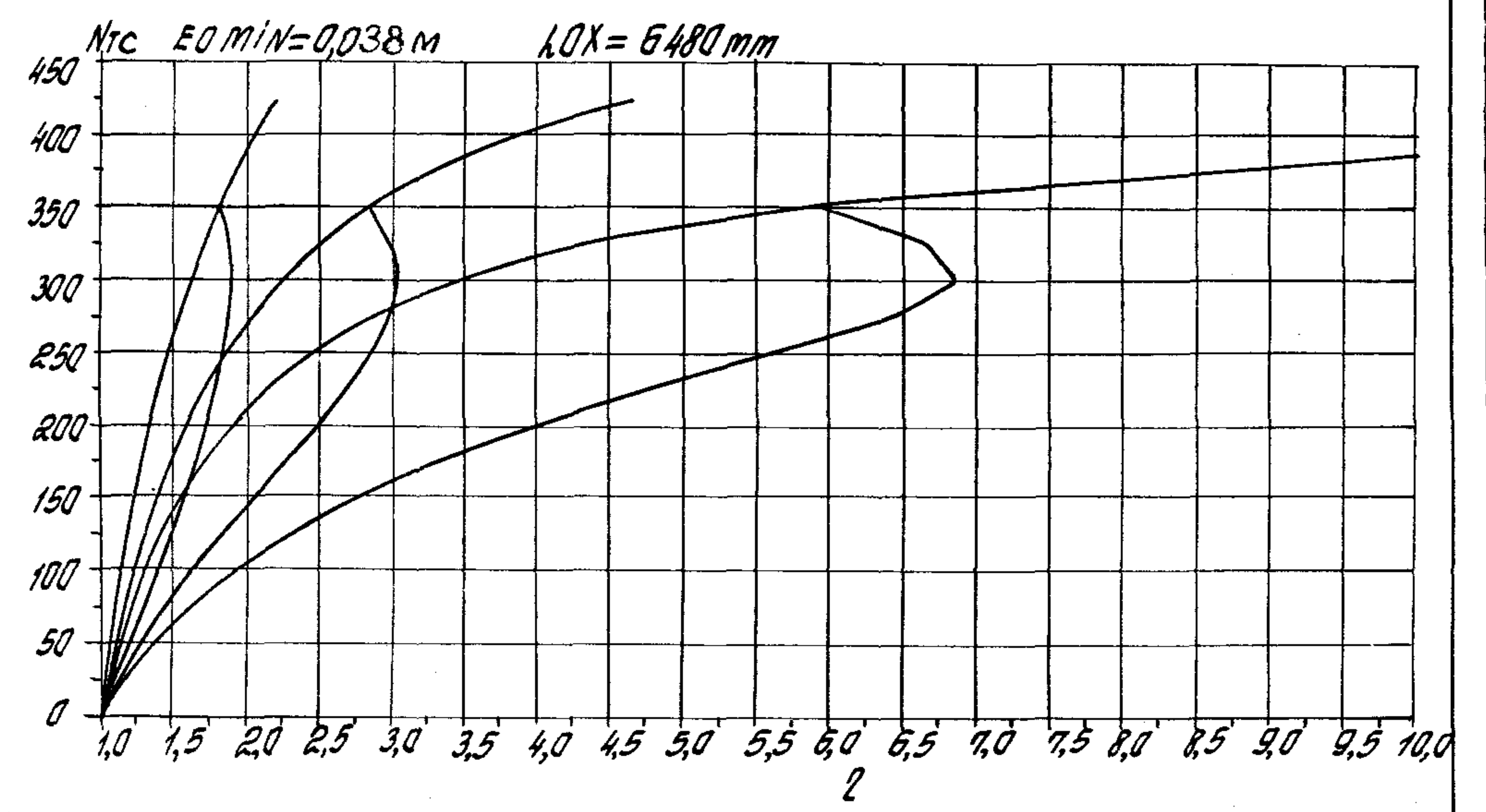
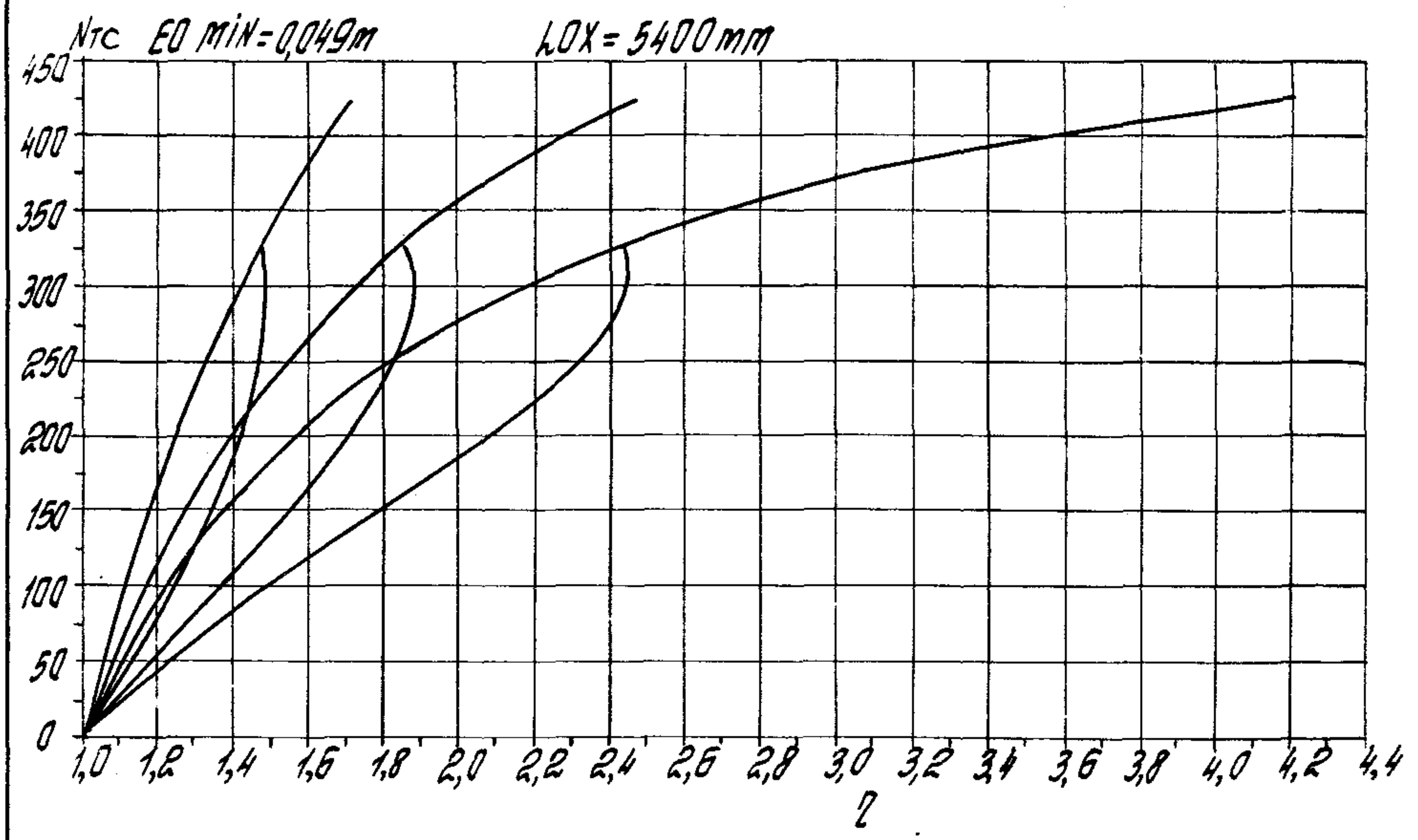

ЧИСТ. № ПОДАТО
 ЧИСТ. № ПОДАТО
 ЧИСТ. № ПОДАТО

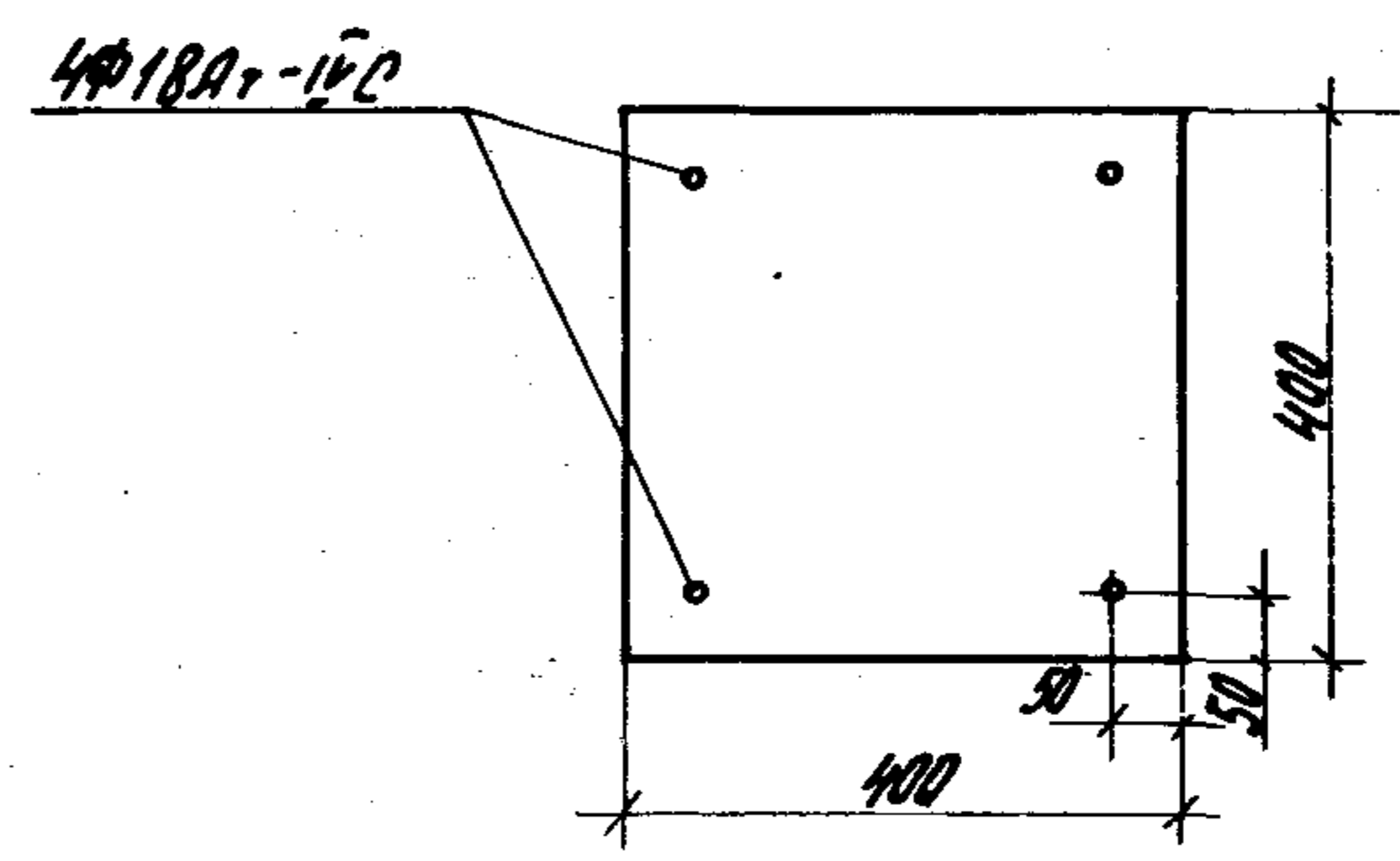

Класс бетона В40,0 ($R_b = 19,8 \text{ МПа}$; $\gamma_{b2} = 0,90$)

Сталь АТ-IVC

Код сечения - 1068

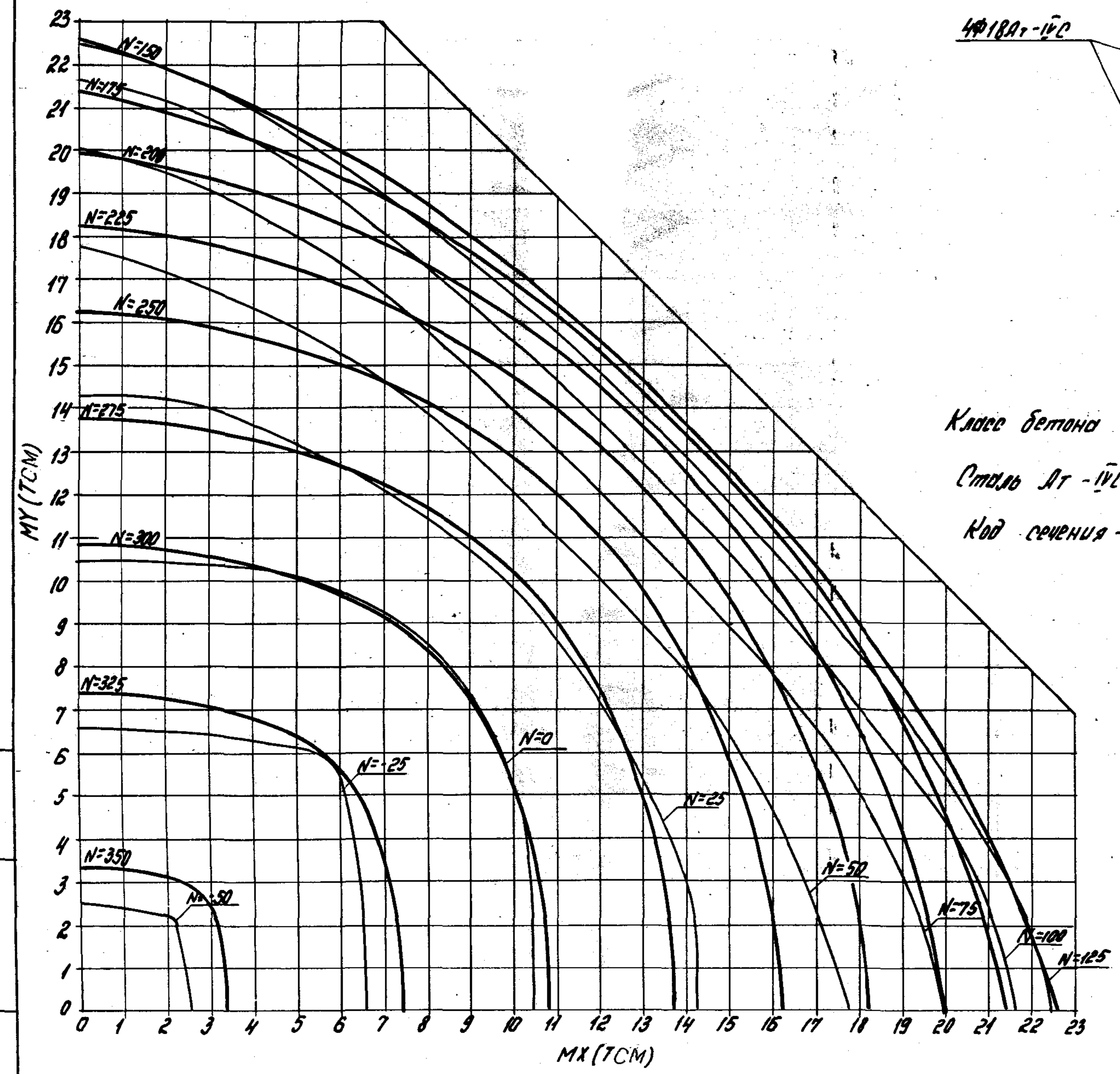

Лист № 001. Подпись и дата. 02.04.2012 г.

1.020. 1-4 0-9 002 1/100m
45

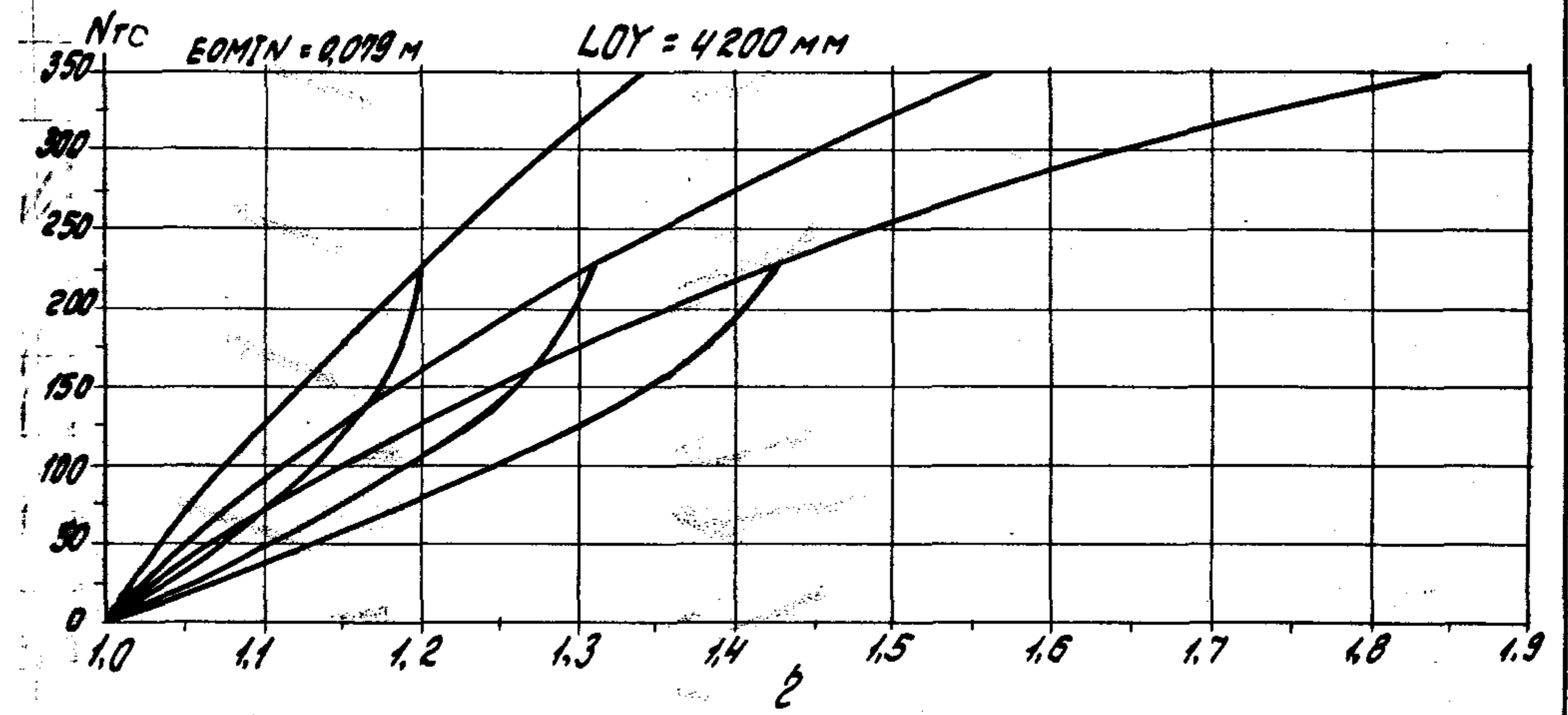
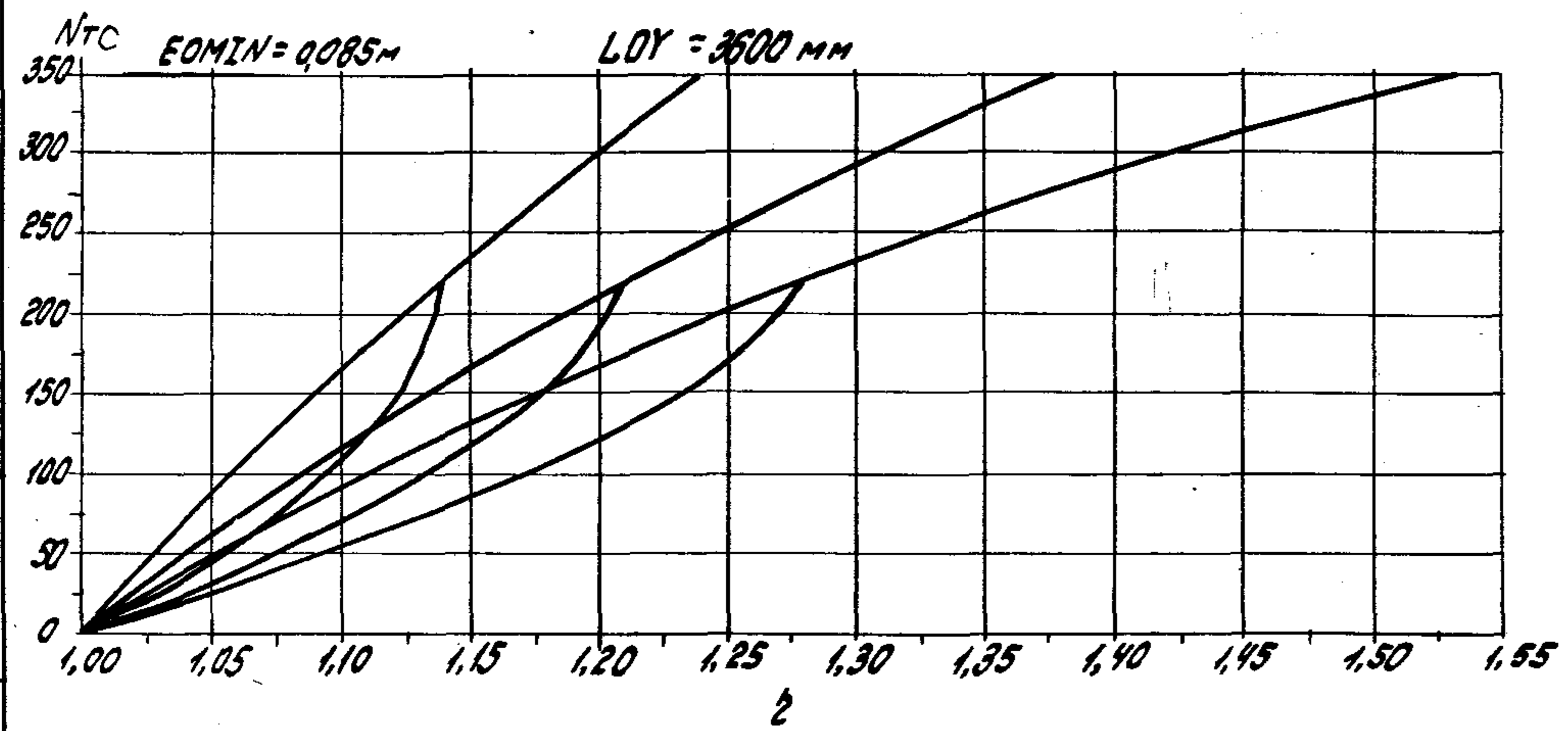
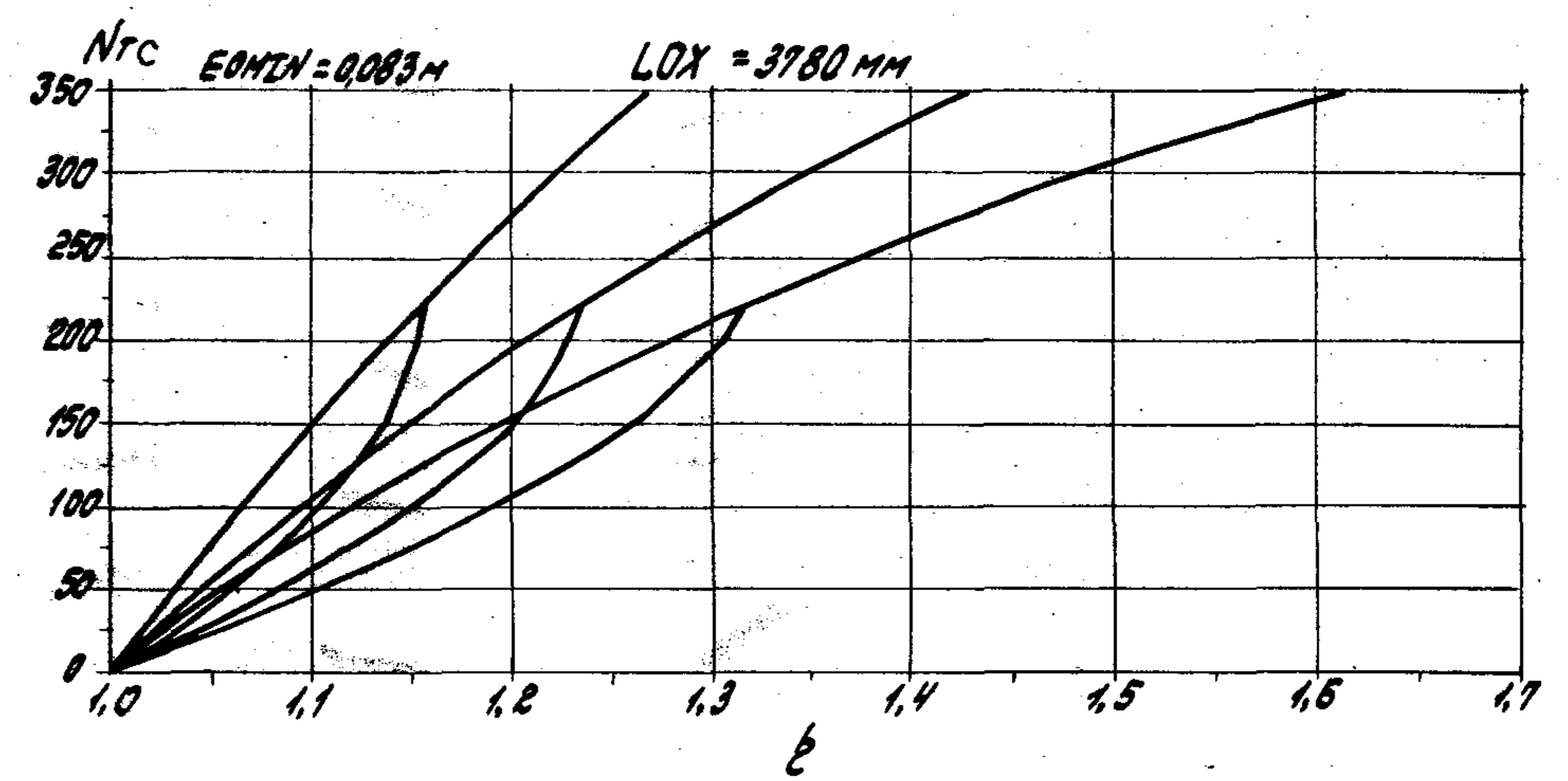
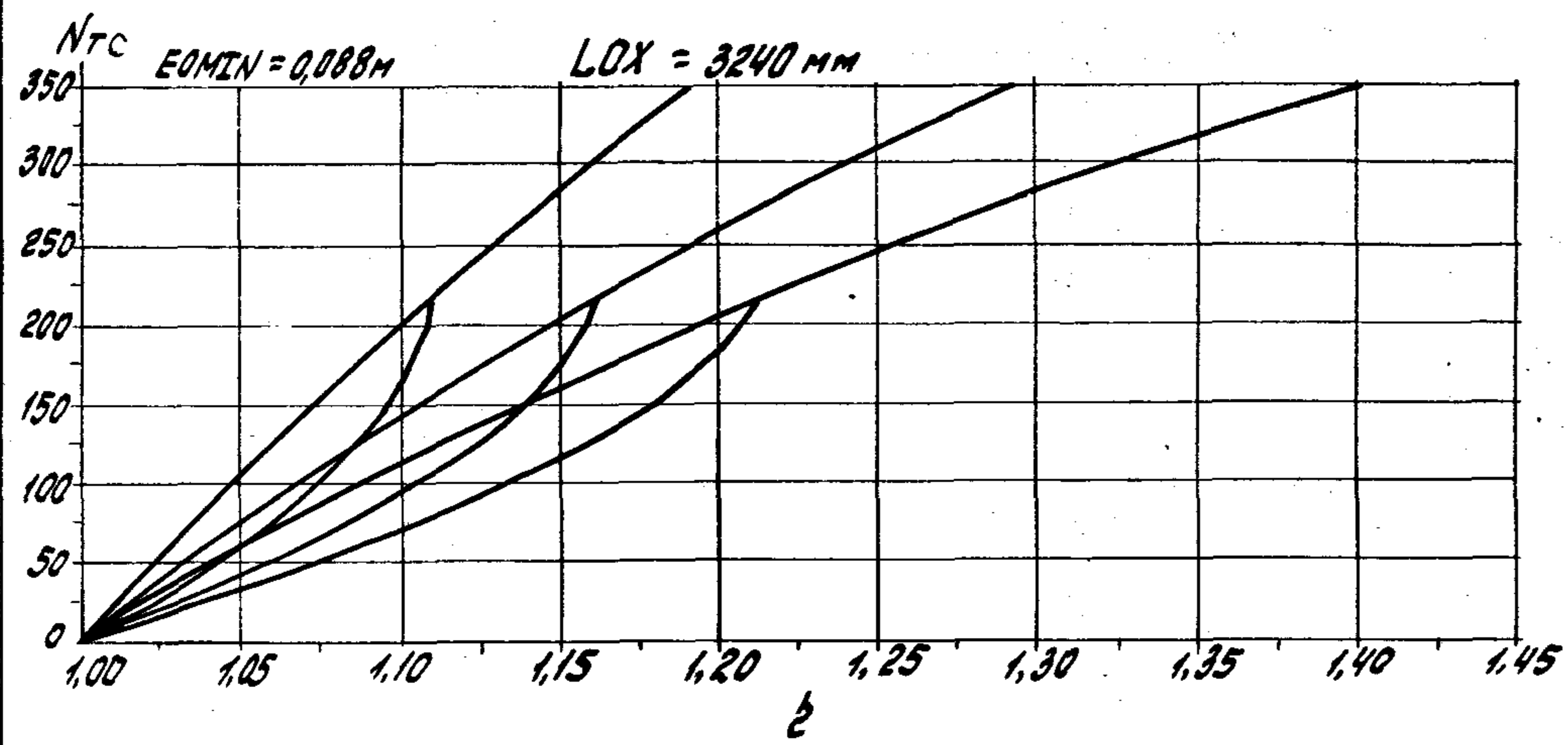

MECHANICAL PROPERTY CURVES

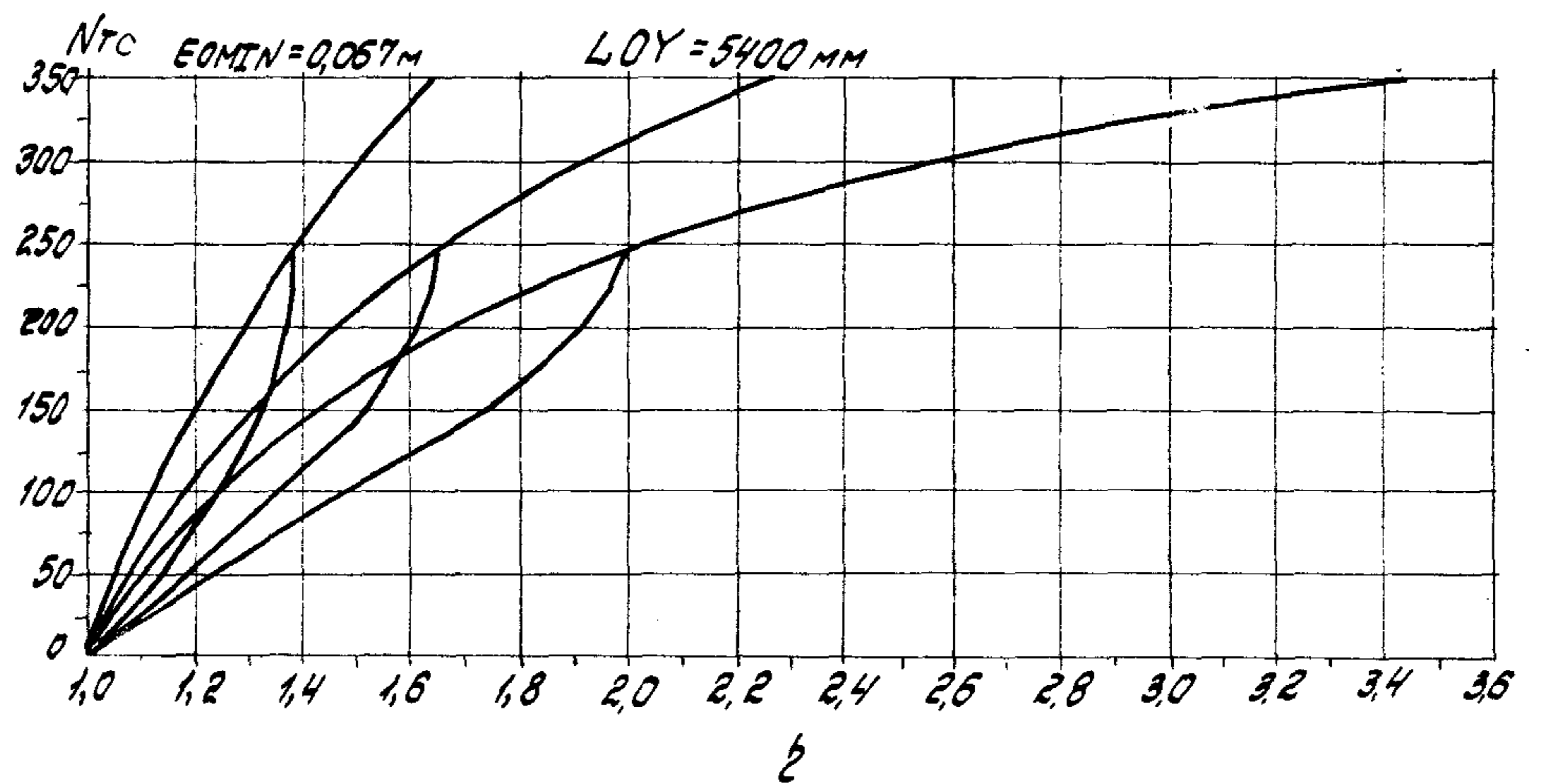
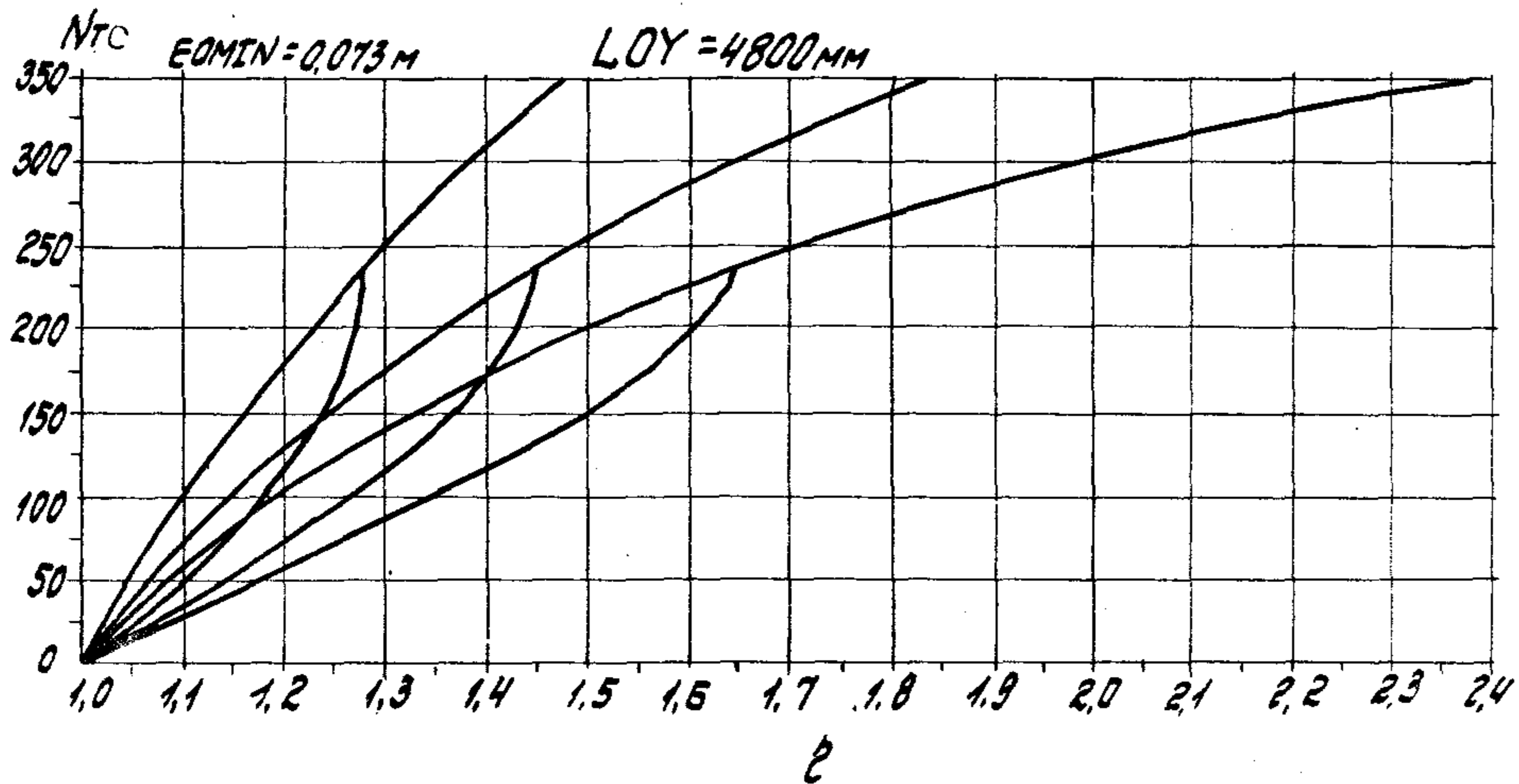
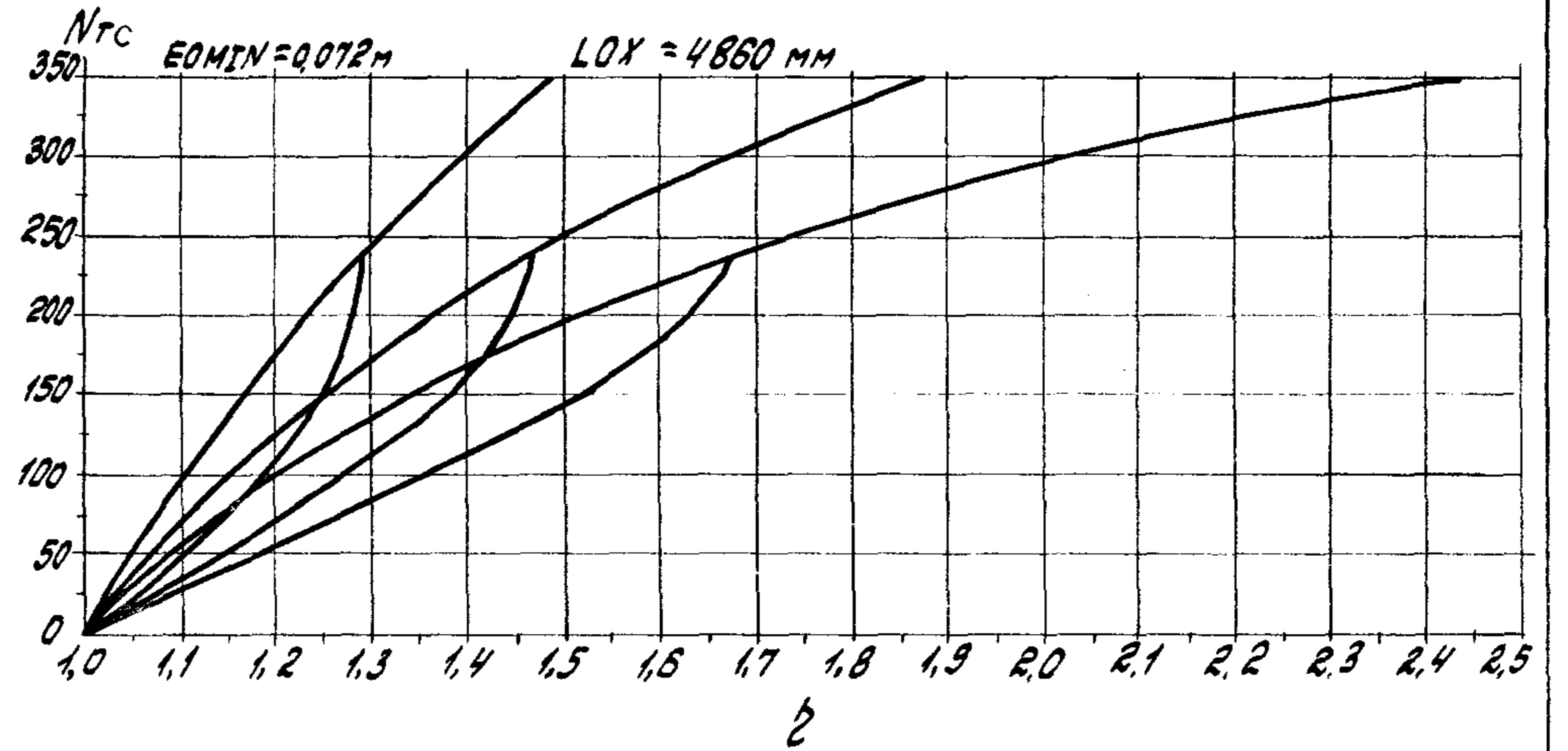
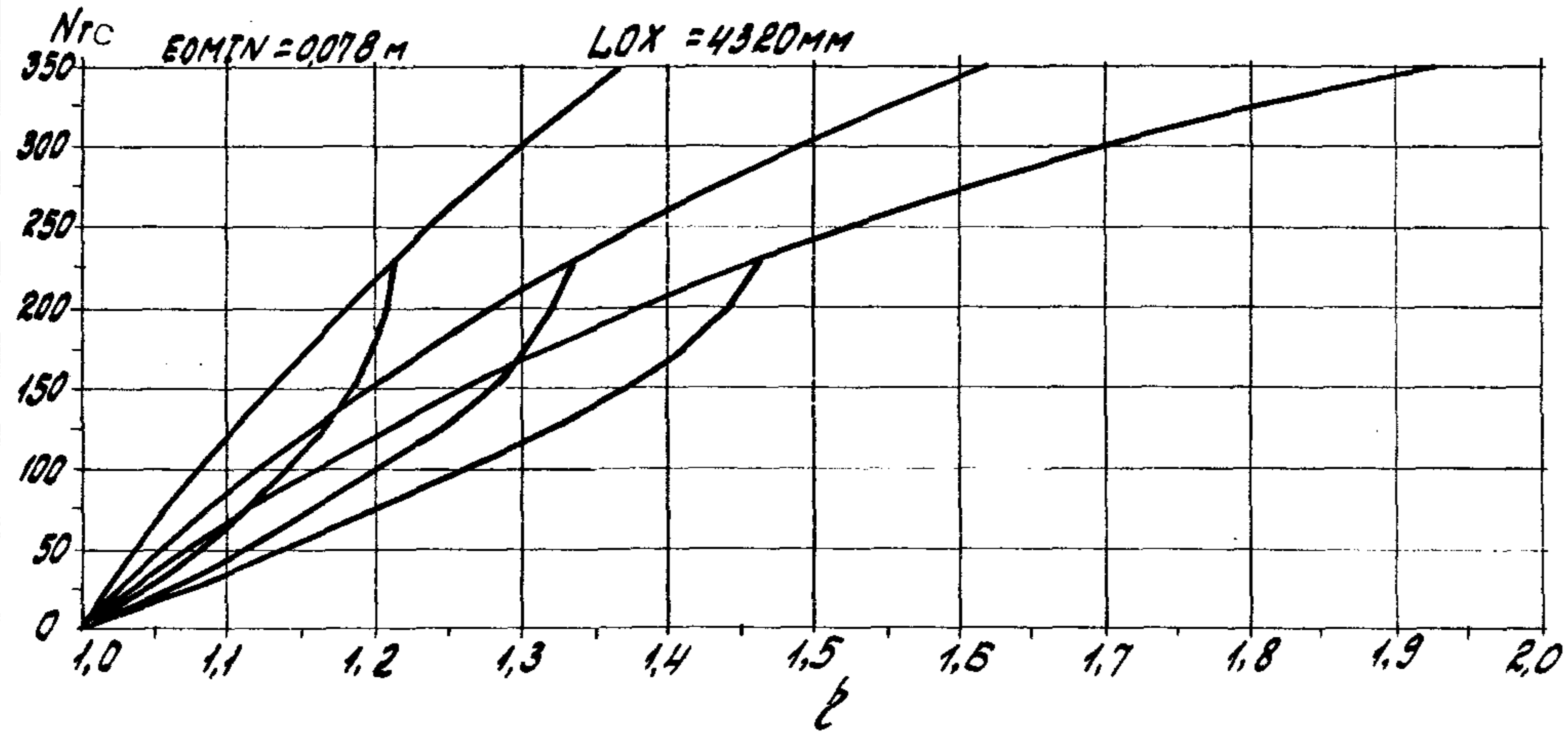

1.020 1-4 8-9 002 47

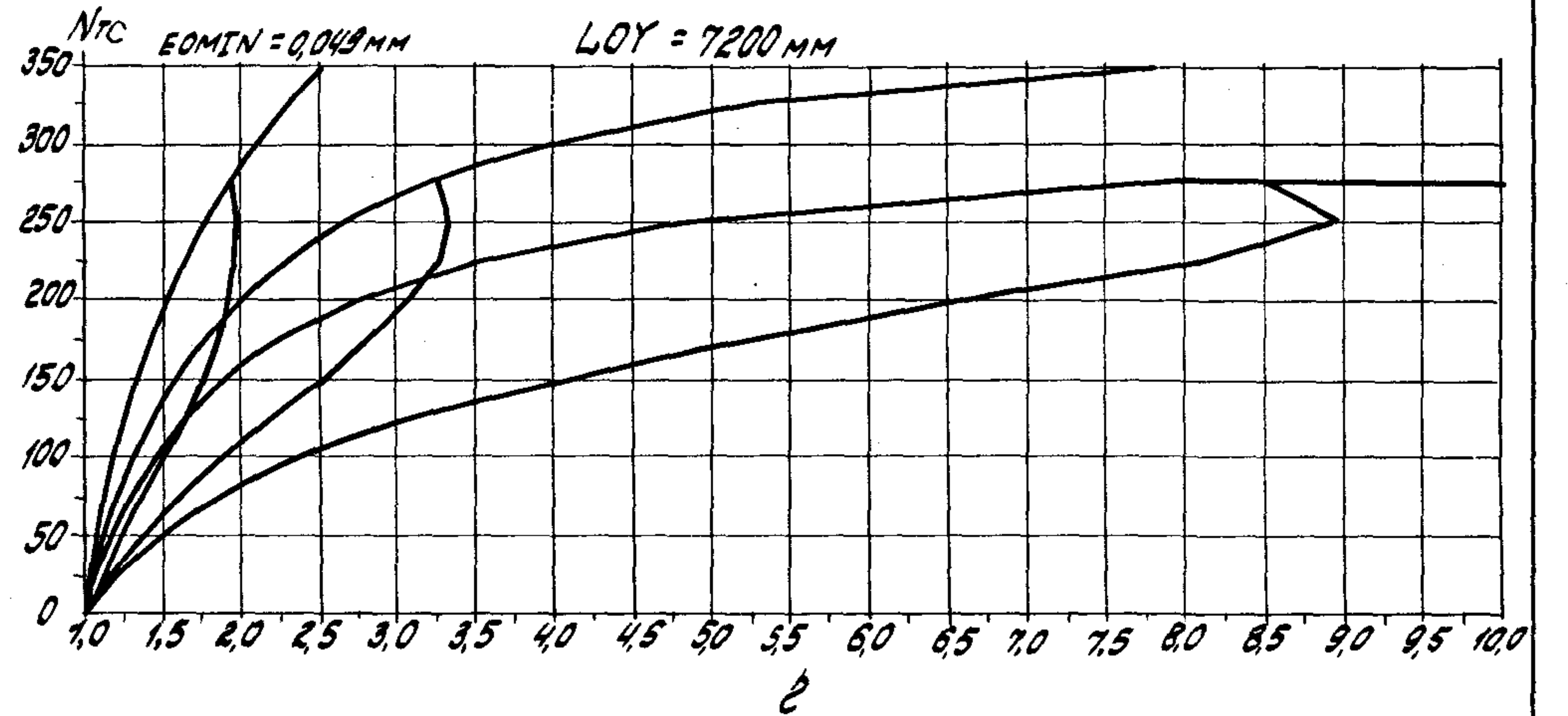
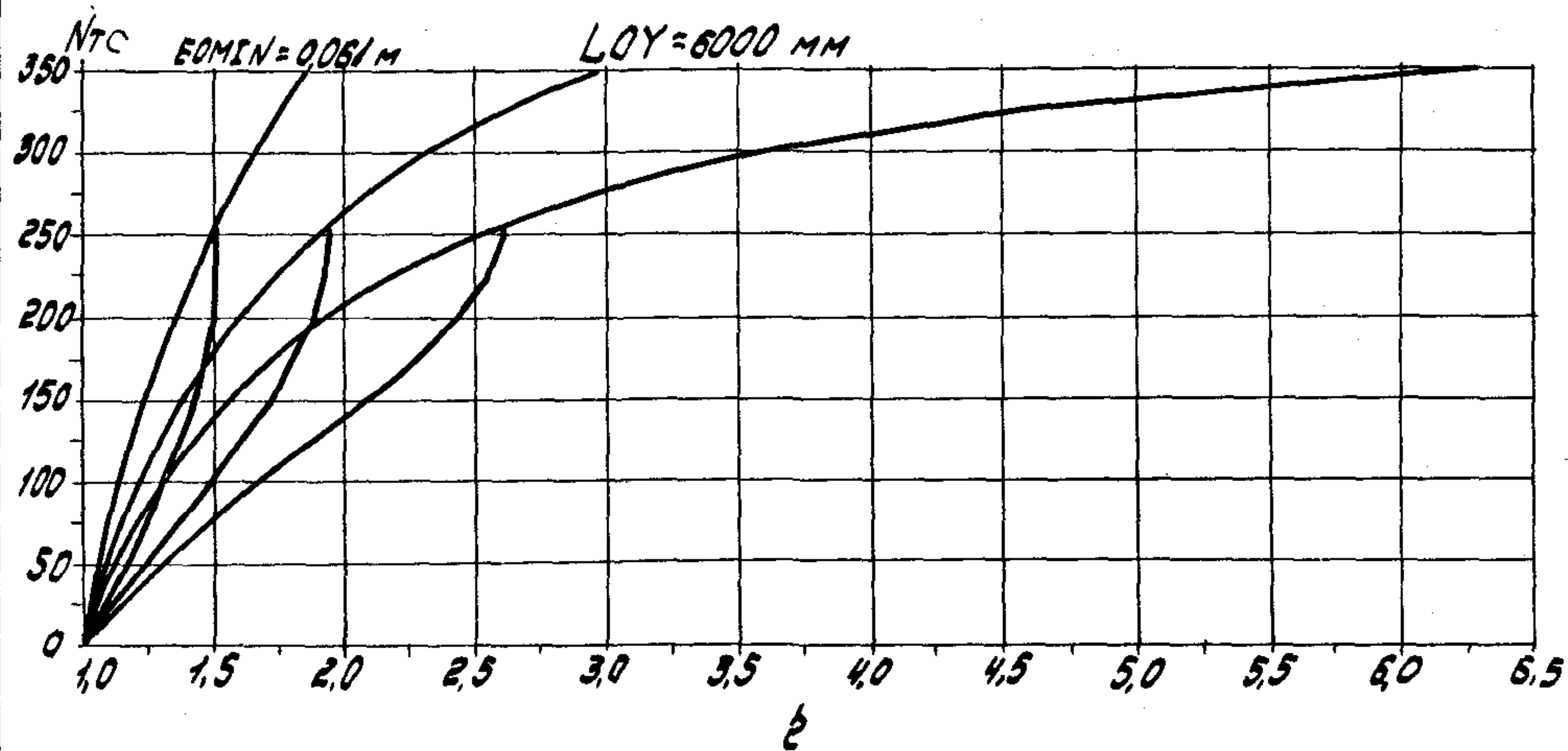
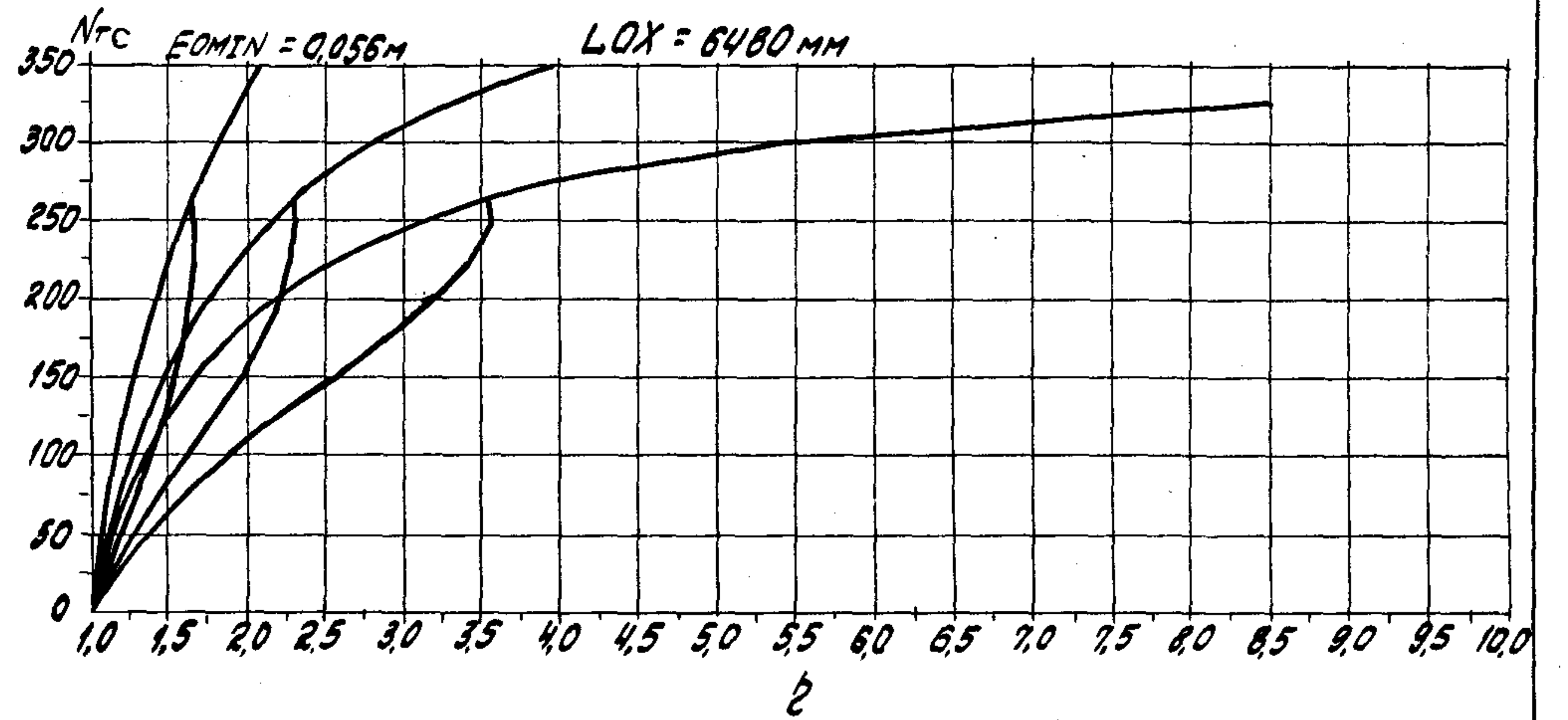
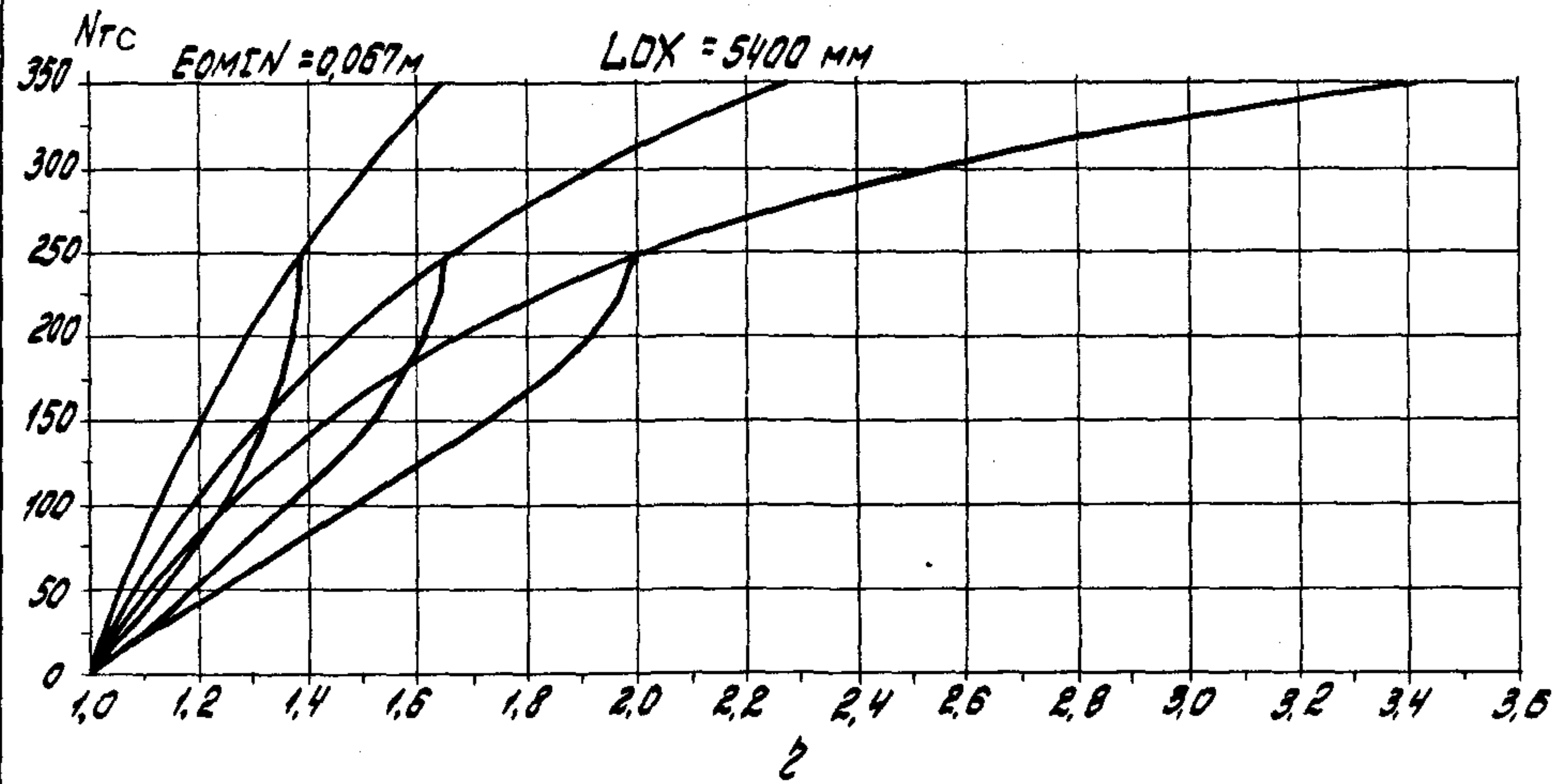

Лист № 10

Лист № 10

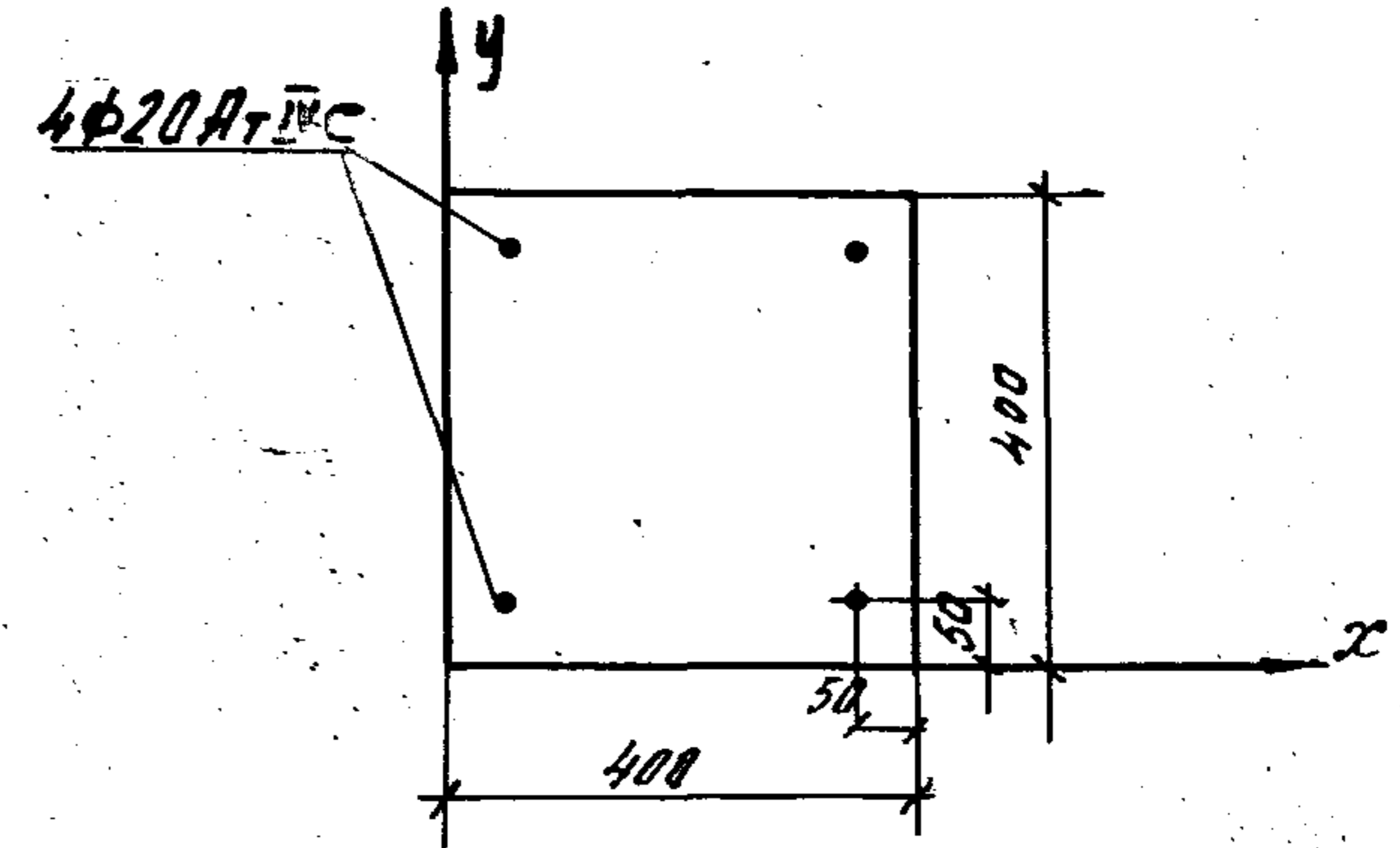
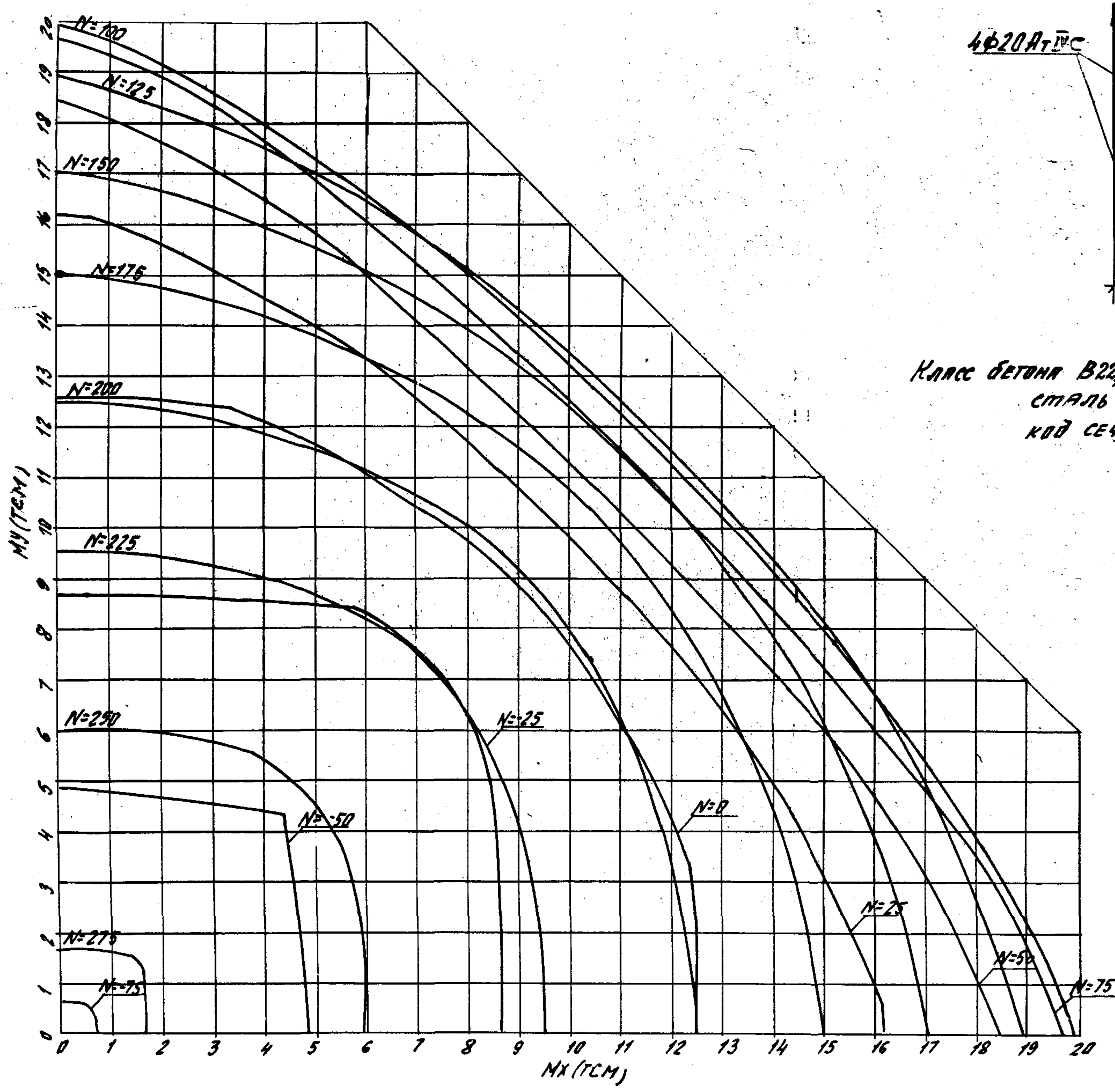

Класс бетона В22,5 ($R_b = 14,3$ МПа при учете $\gamma_{b2} = 1,10$)
 сталь АТ-IV с
 код сечения - 107a

Имя, № подл. / Подпись и дата / Основание, №

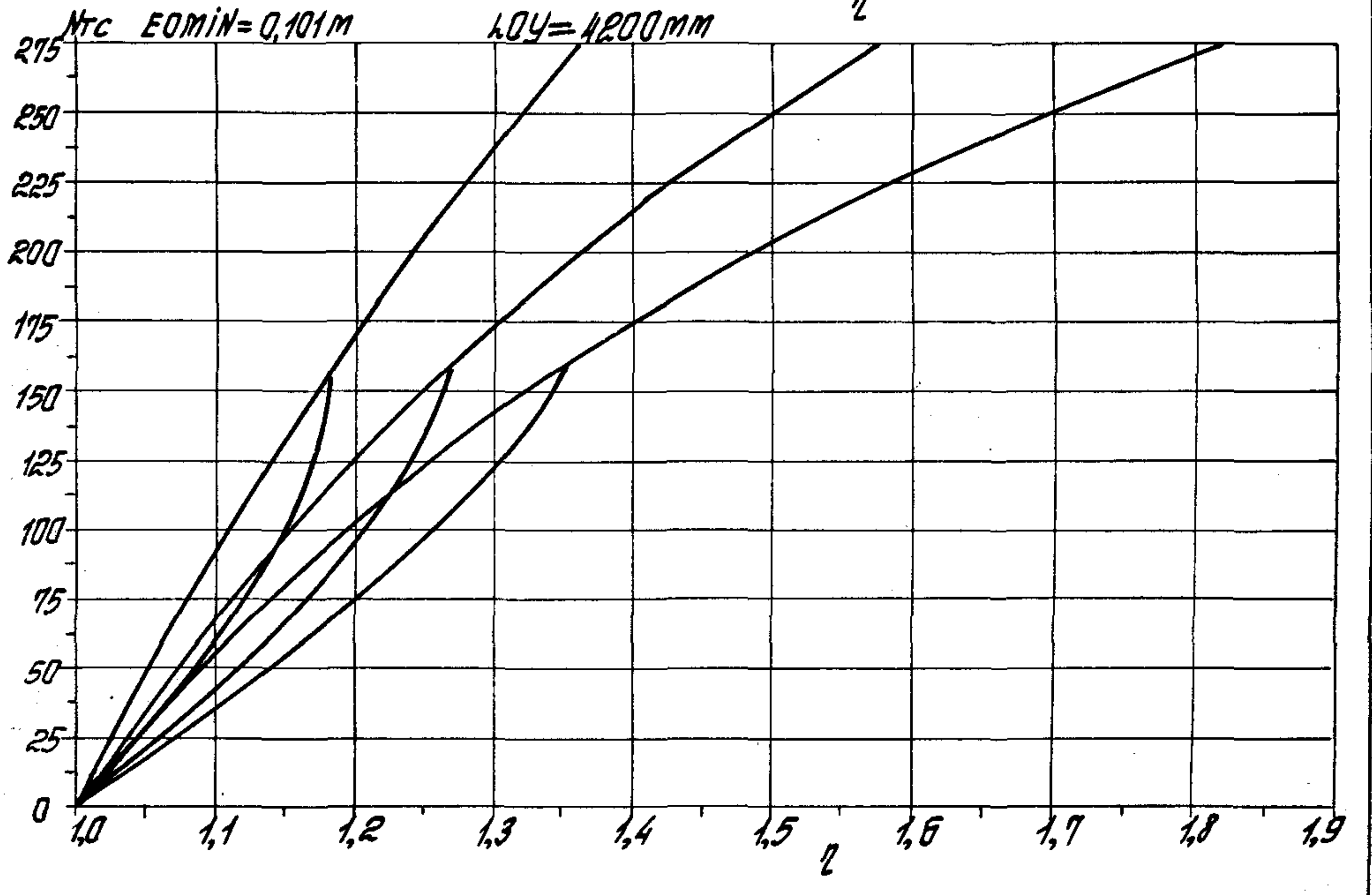
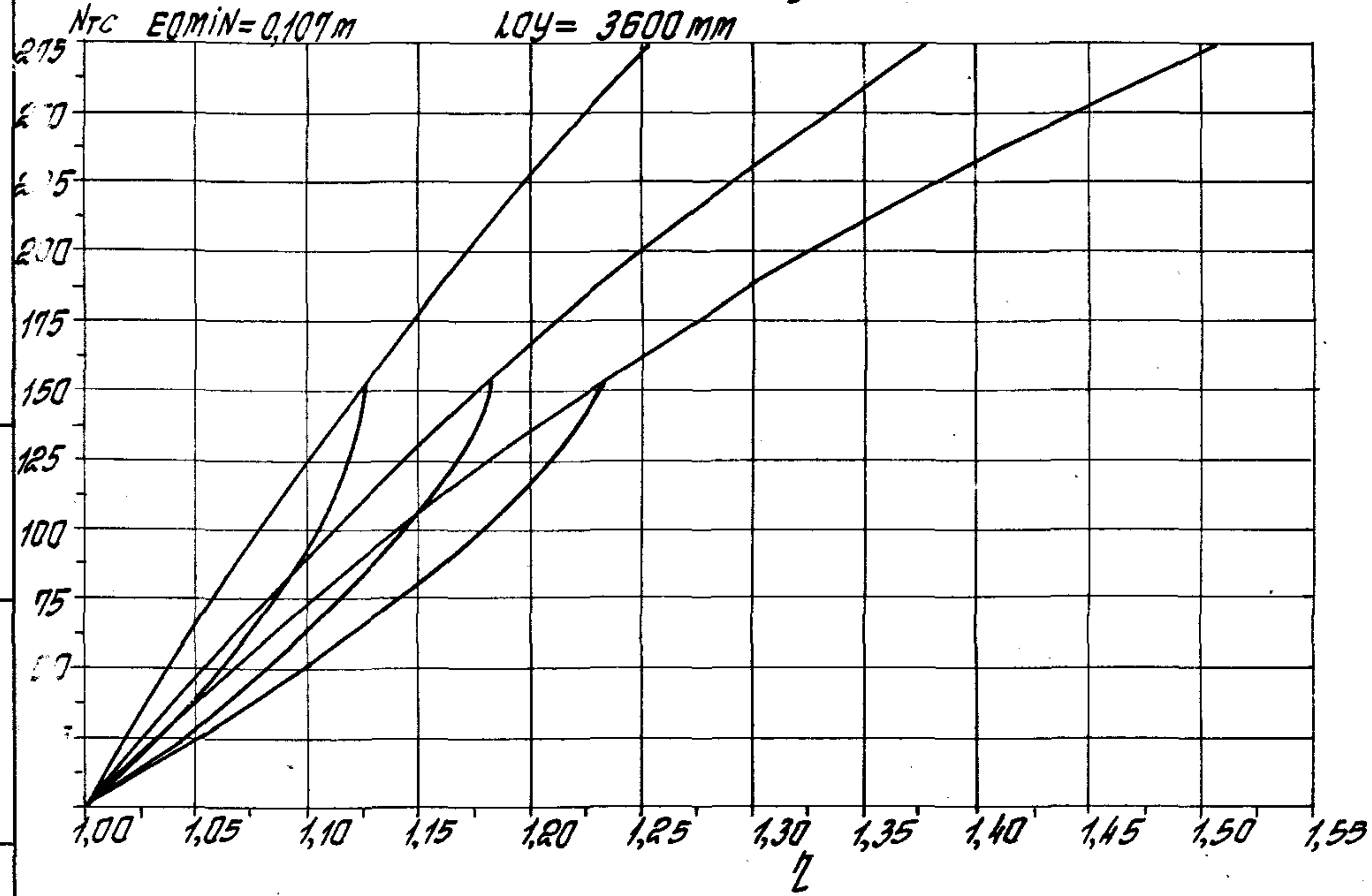
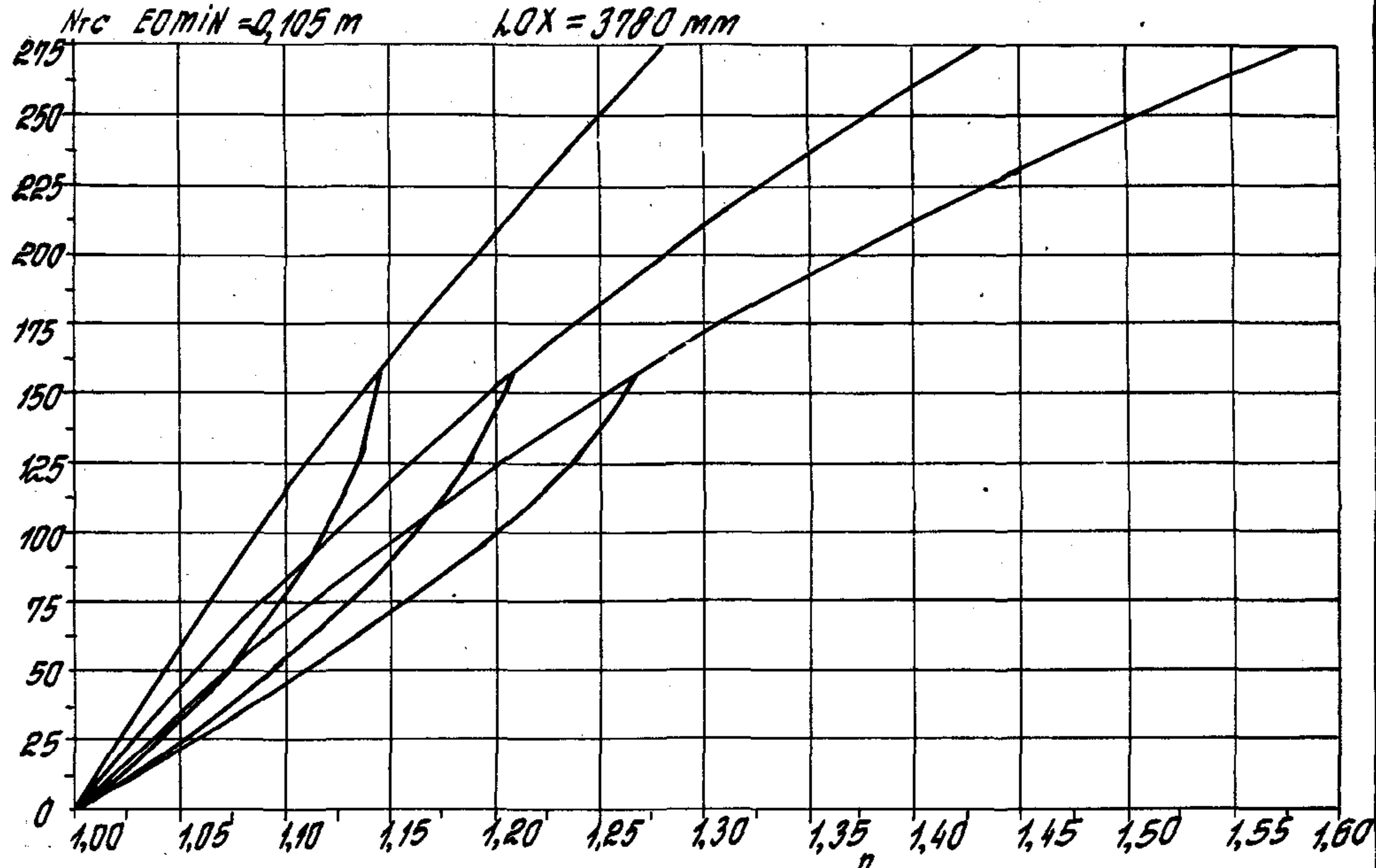
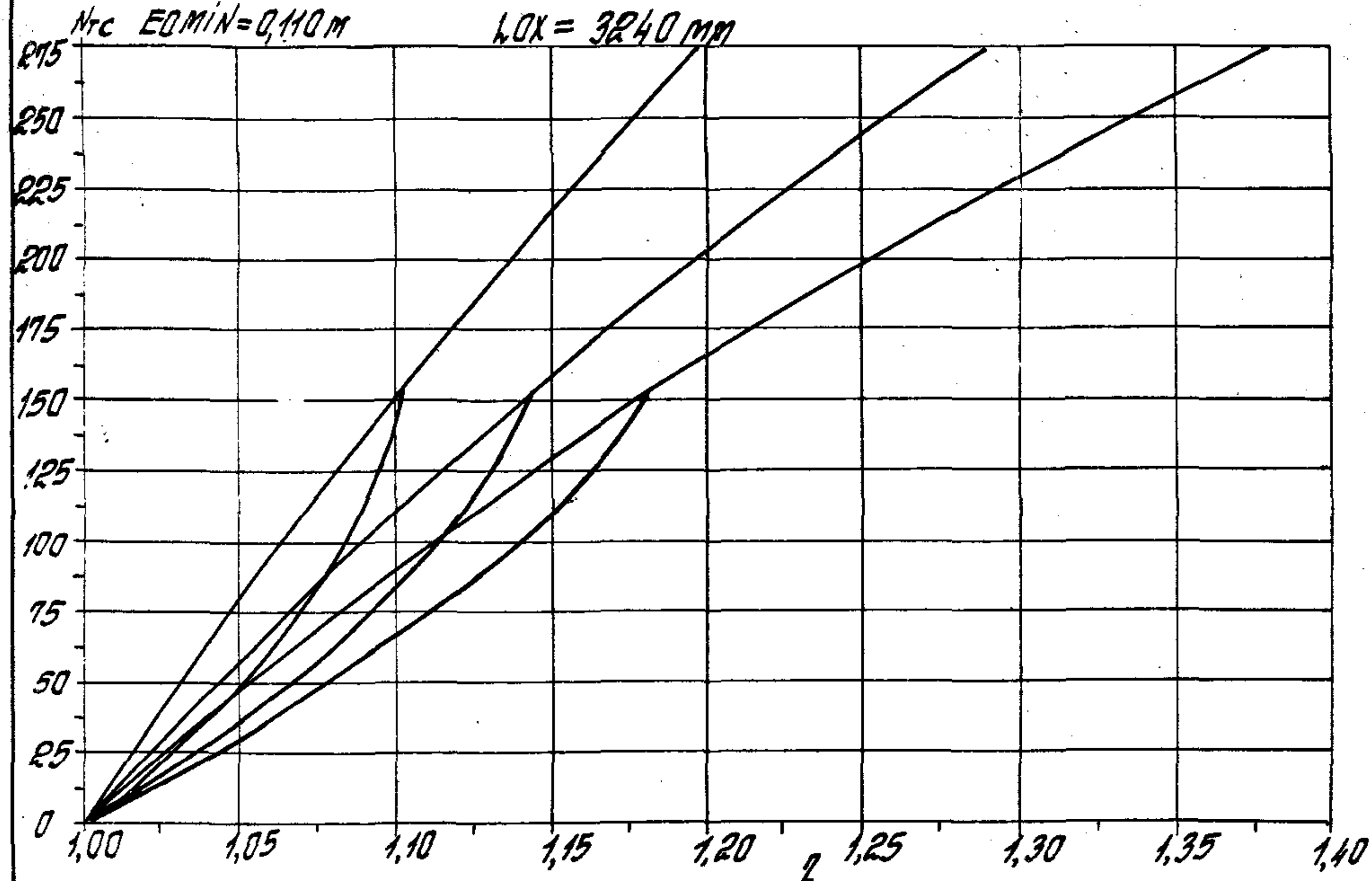

1.020.1-4 0-9 002

Num
50

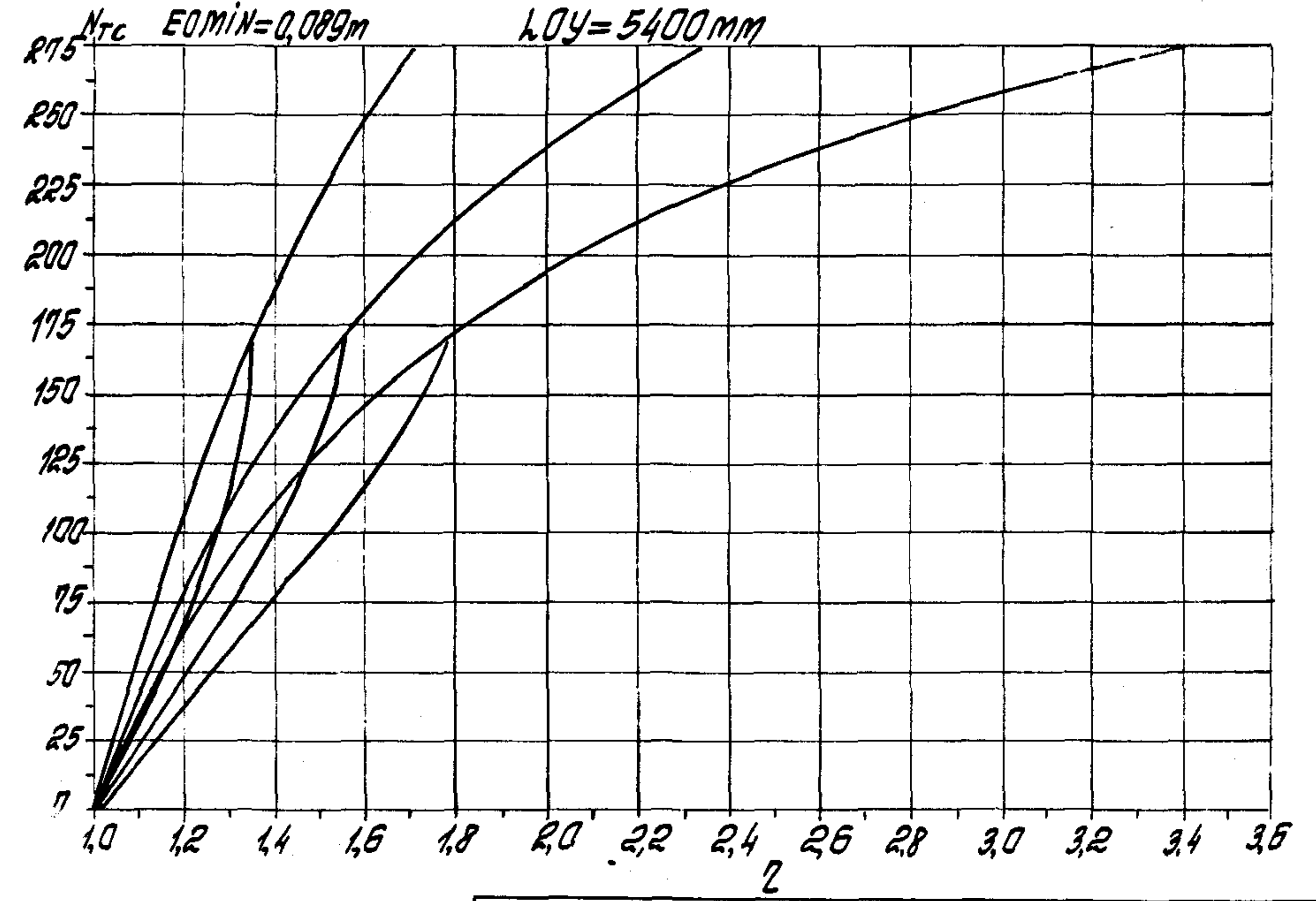
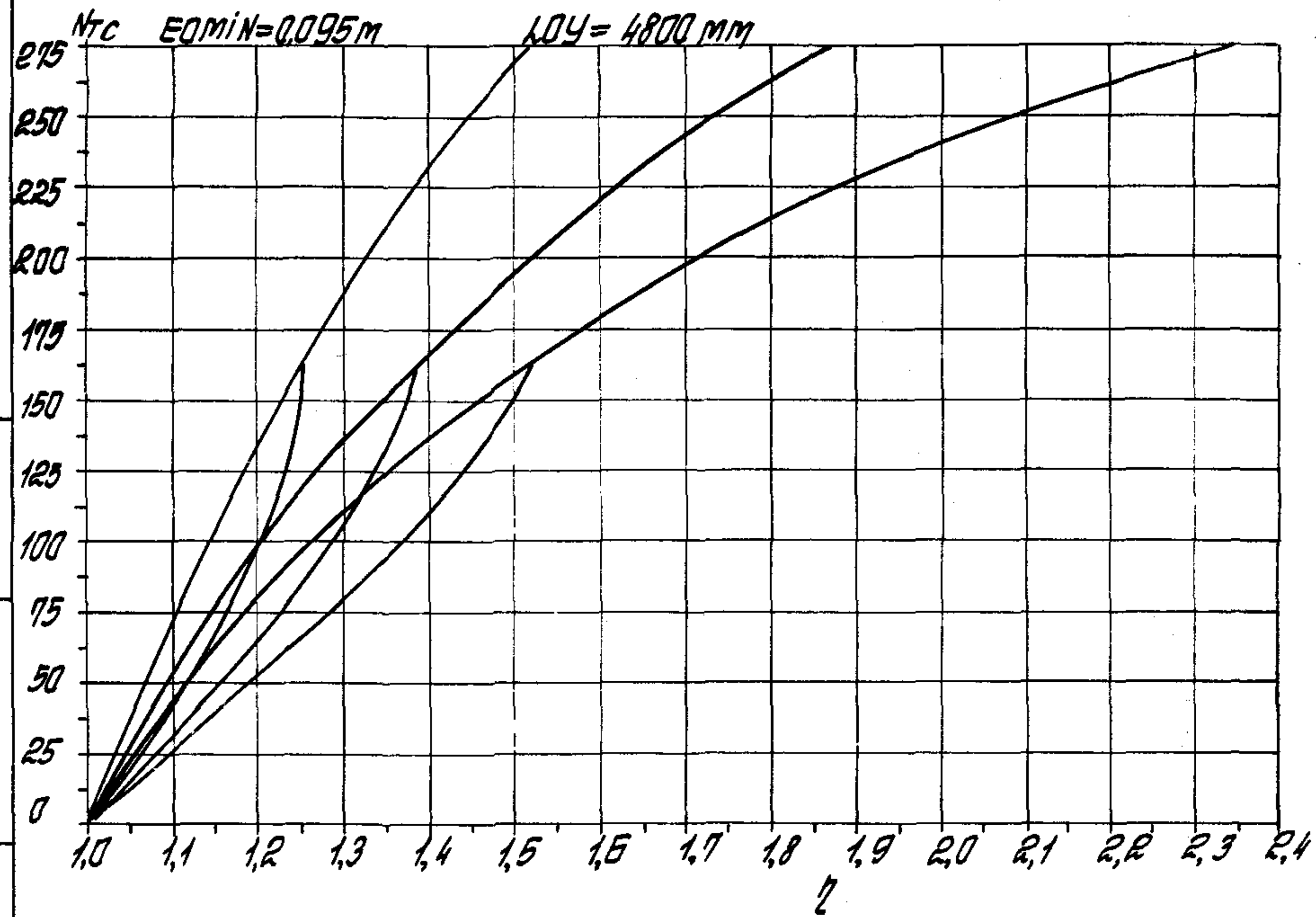
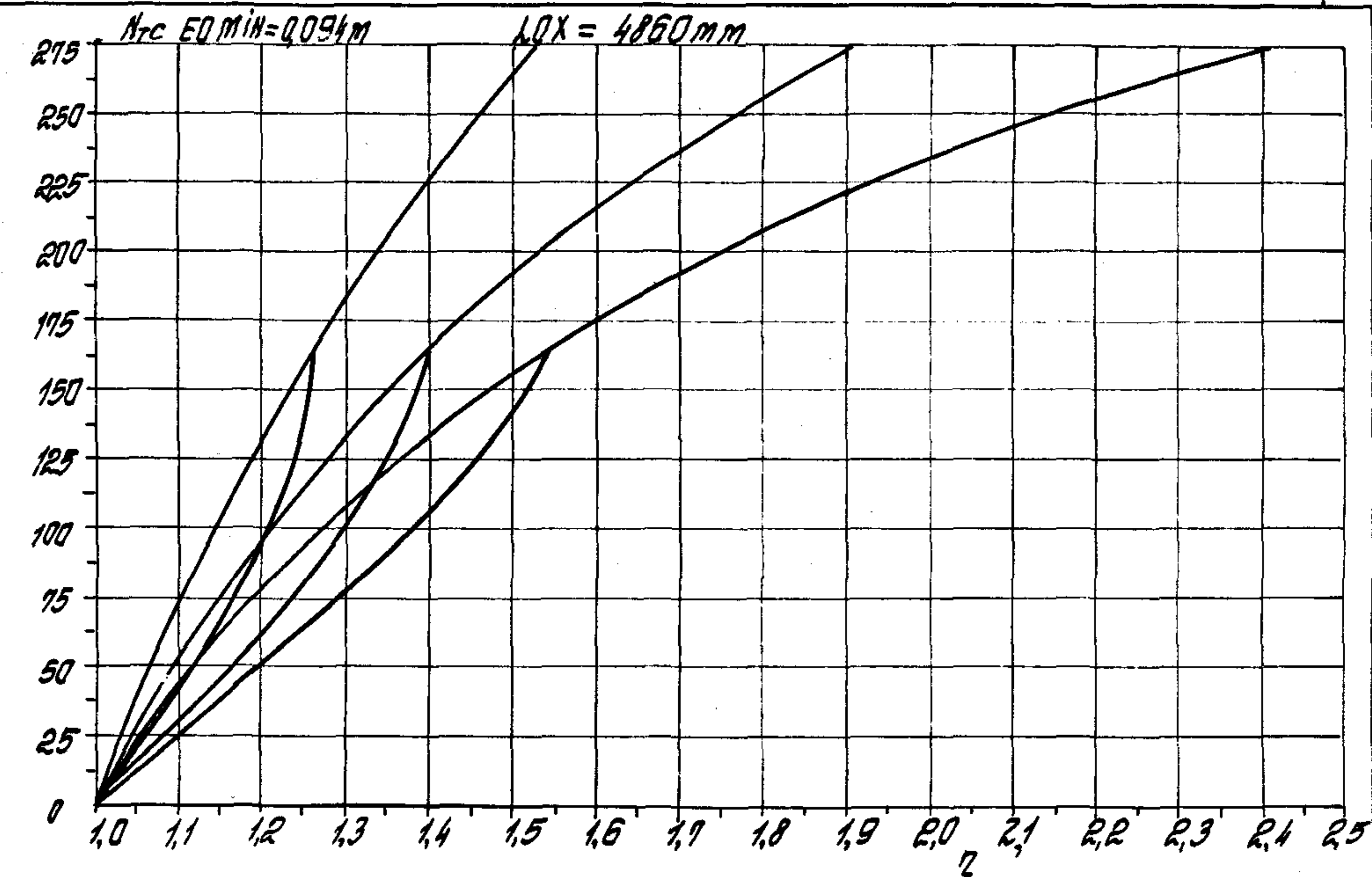
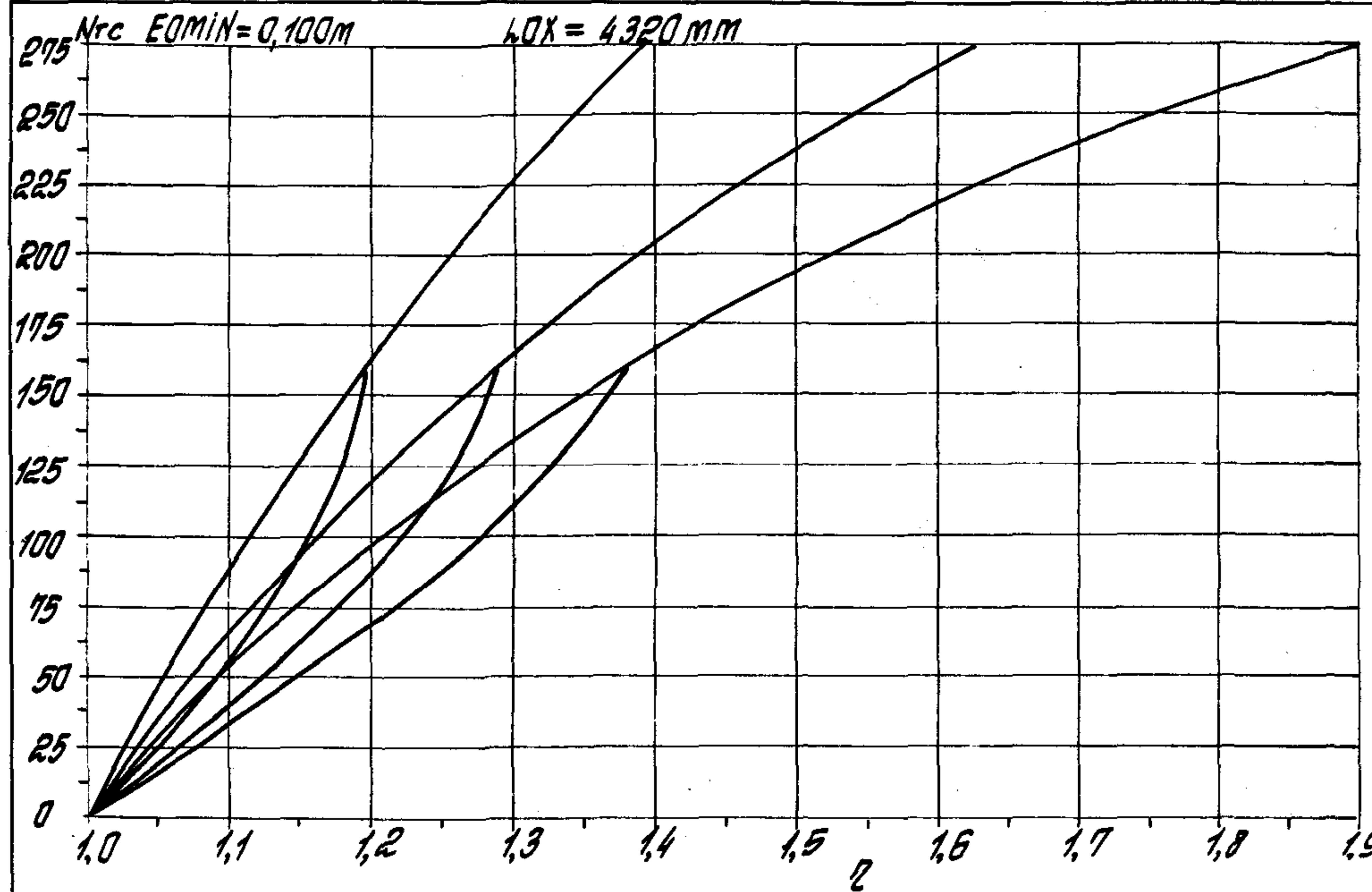

Лист № 0000/000000 в составе № 0000/0000

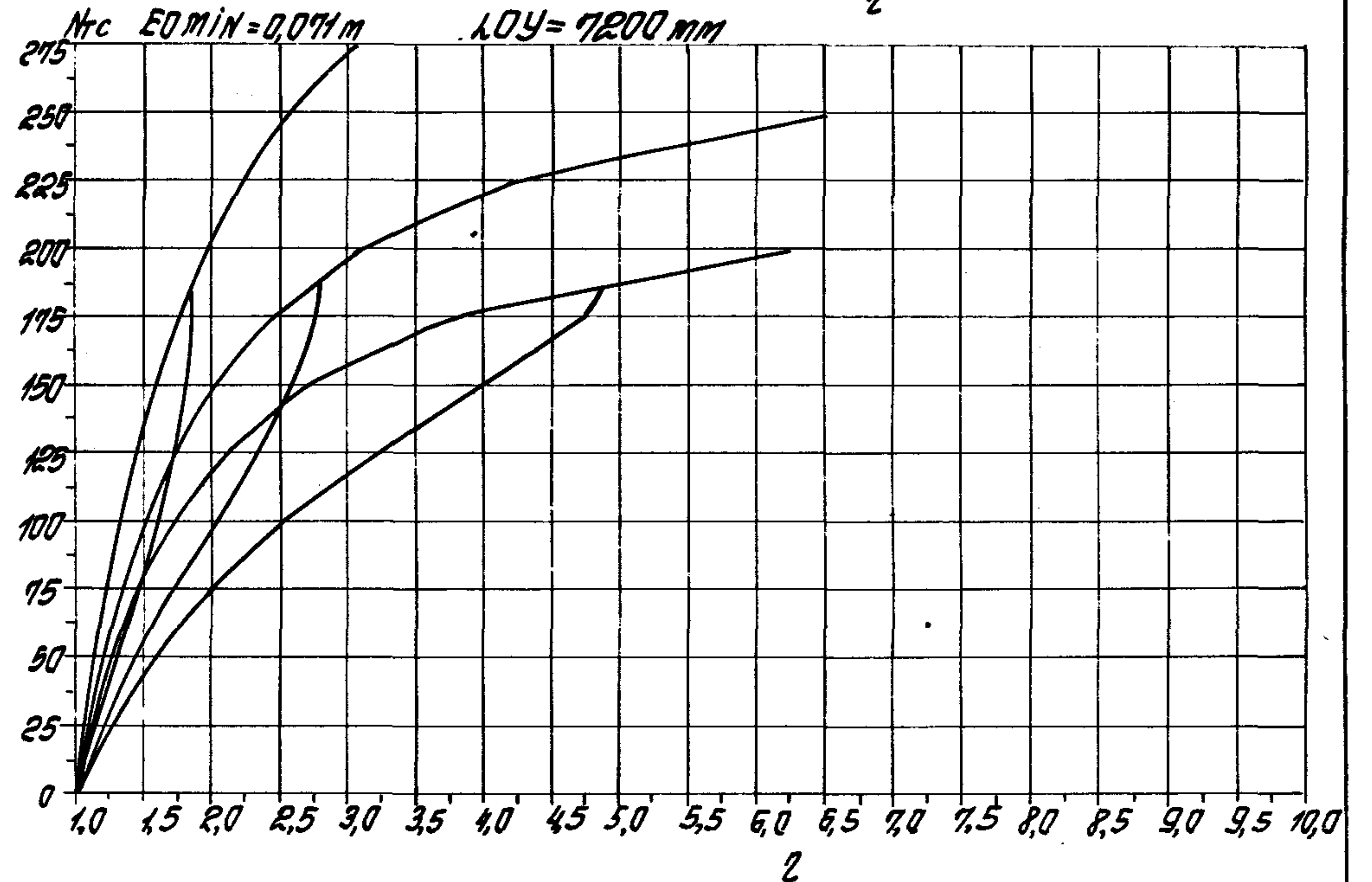
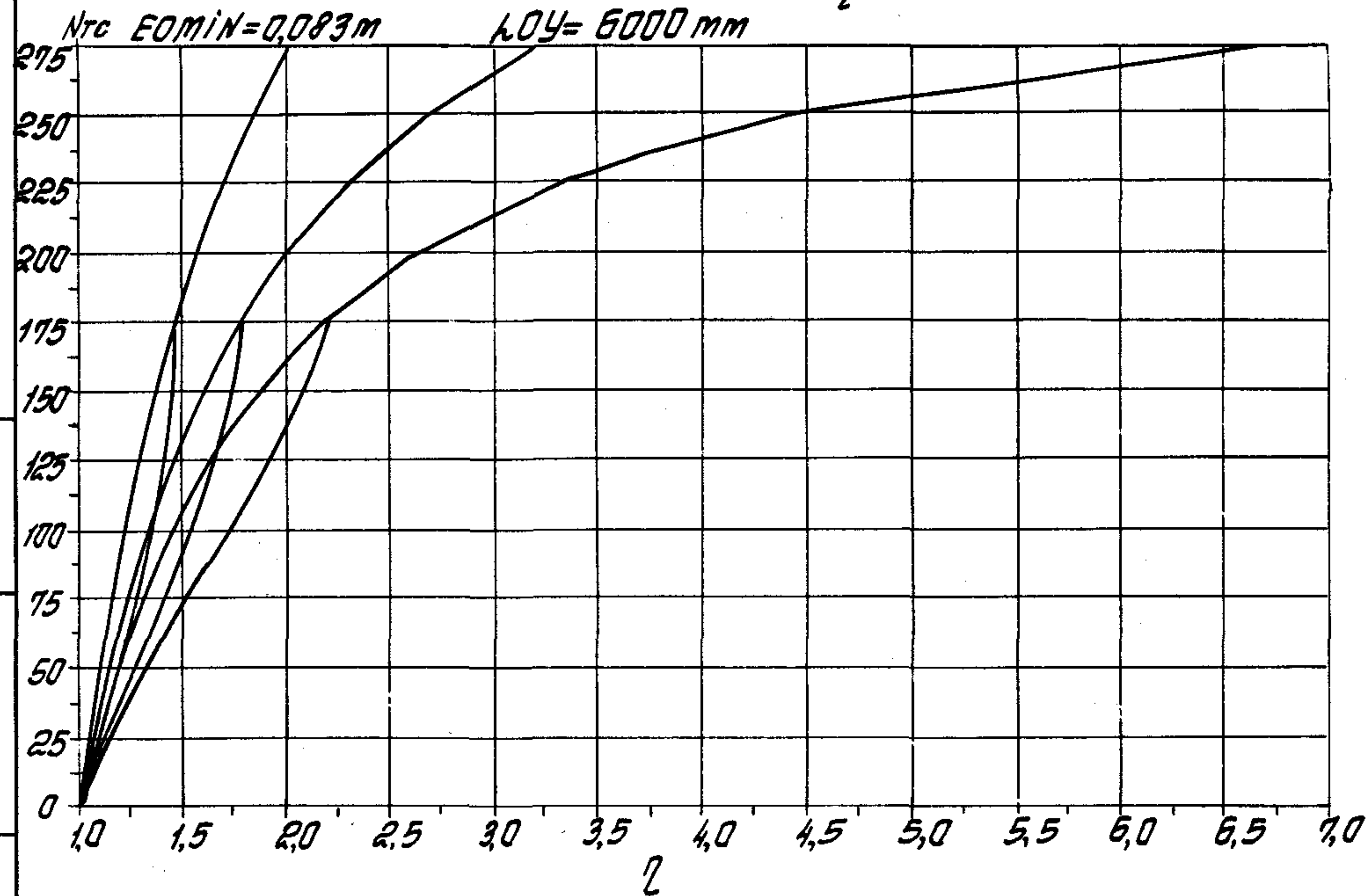
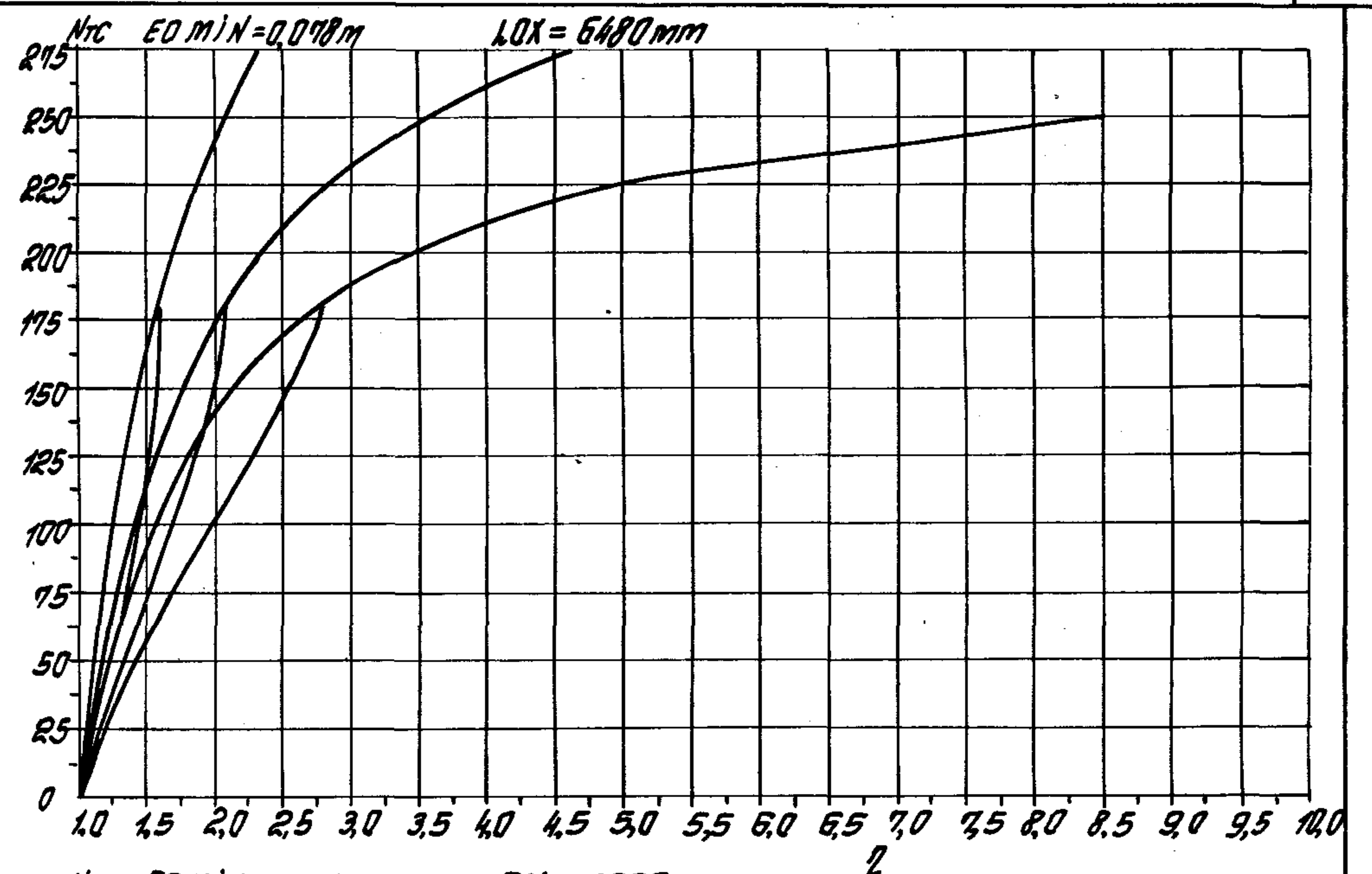
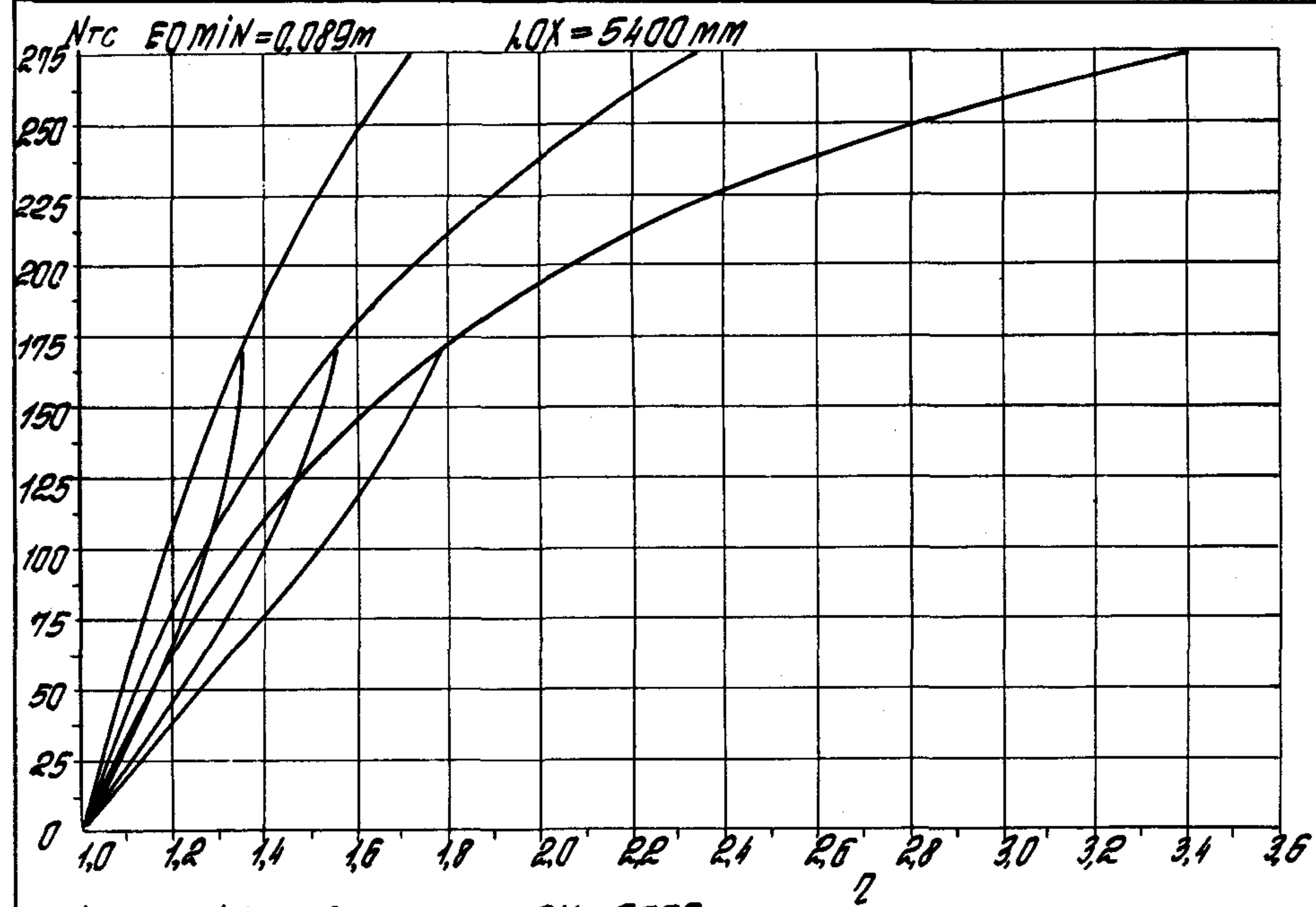

УПРАВЛЕНИЕ ПО ТЕХНИЧЕСКОМУ НАДЗОРУ
 ГОСУДАРСТВЕННОГО КОМПЛЕКСНОГО ЦЕНТРА
 ПО ТЕХНИЧЕСКОМУ НАДЗОРУ

1.020. 1-4 0-9 002

Лист	52
------	----

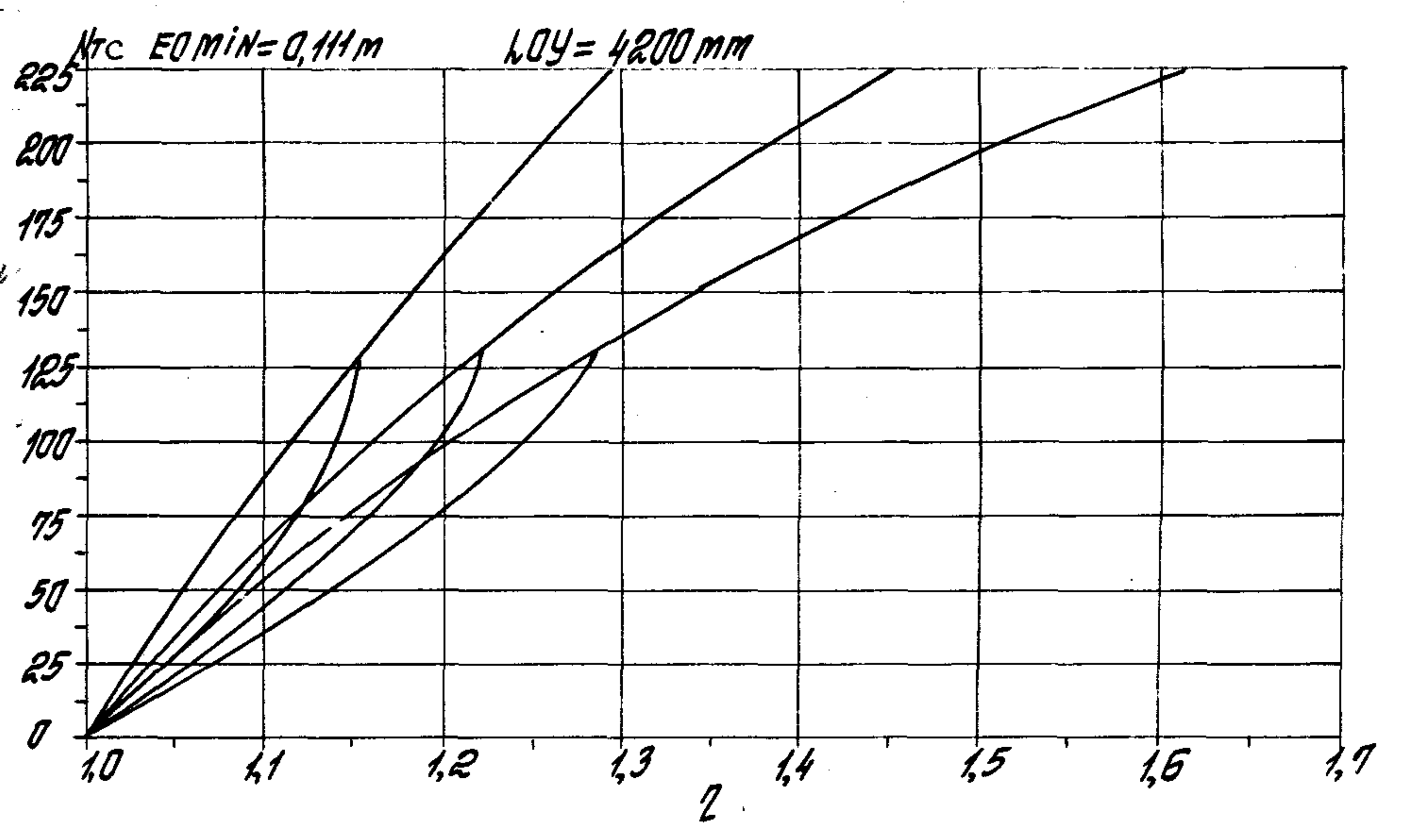
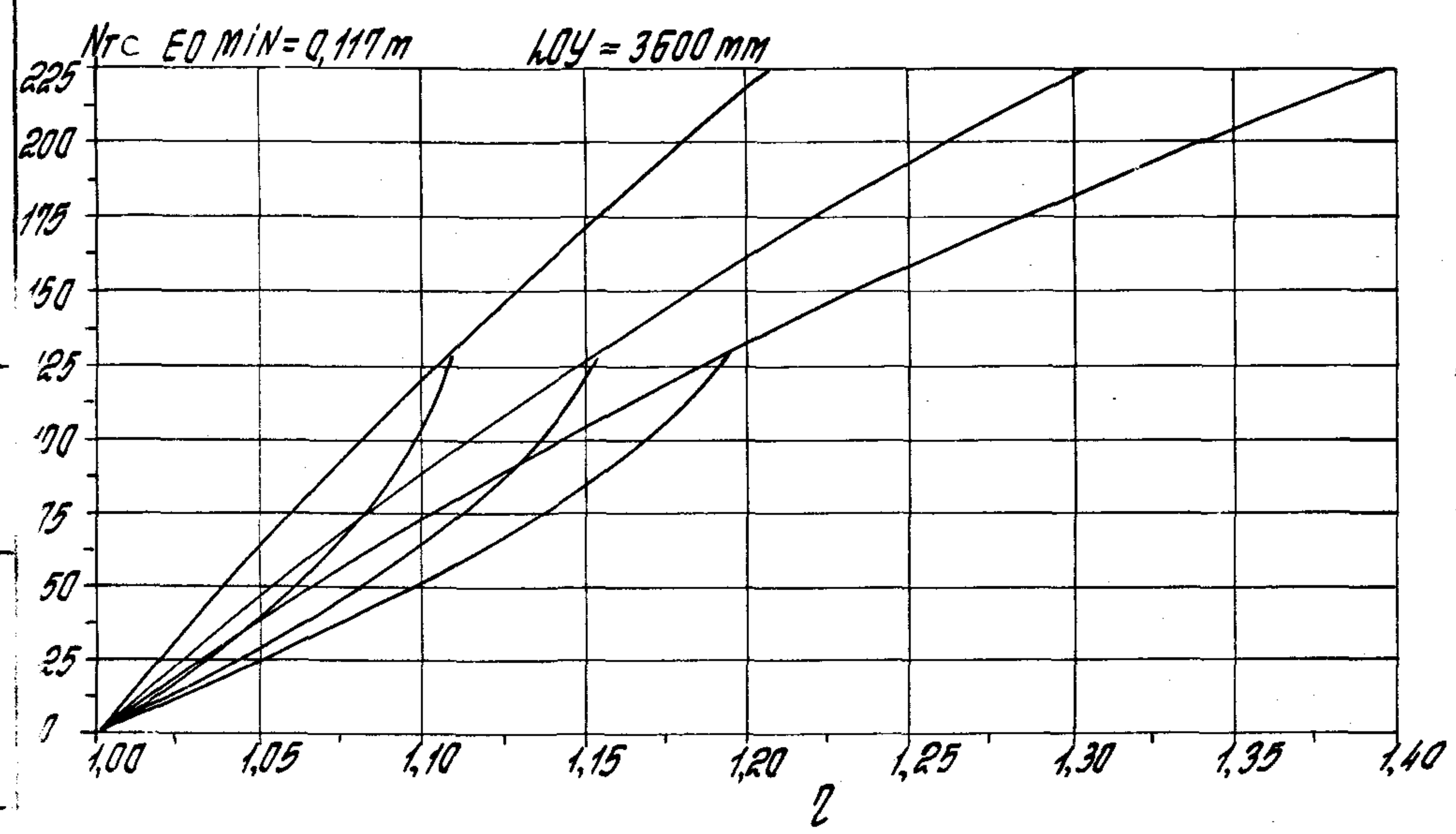
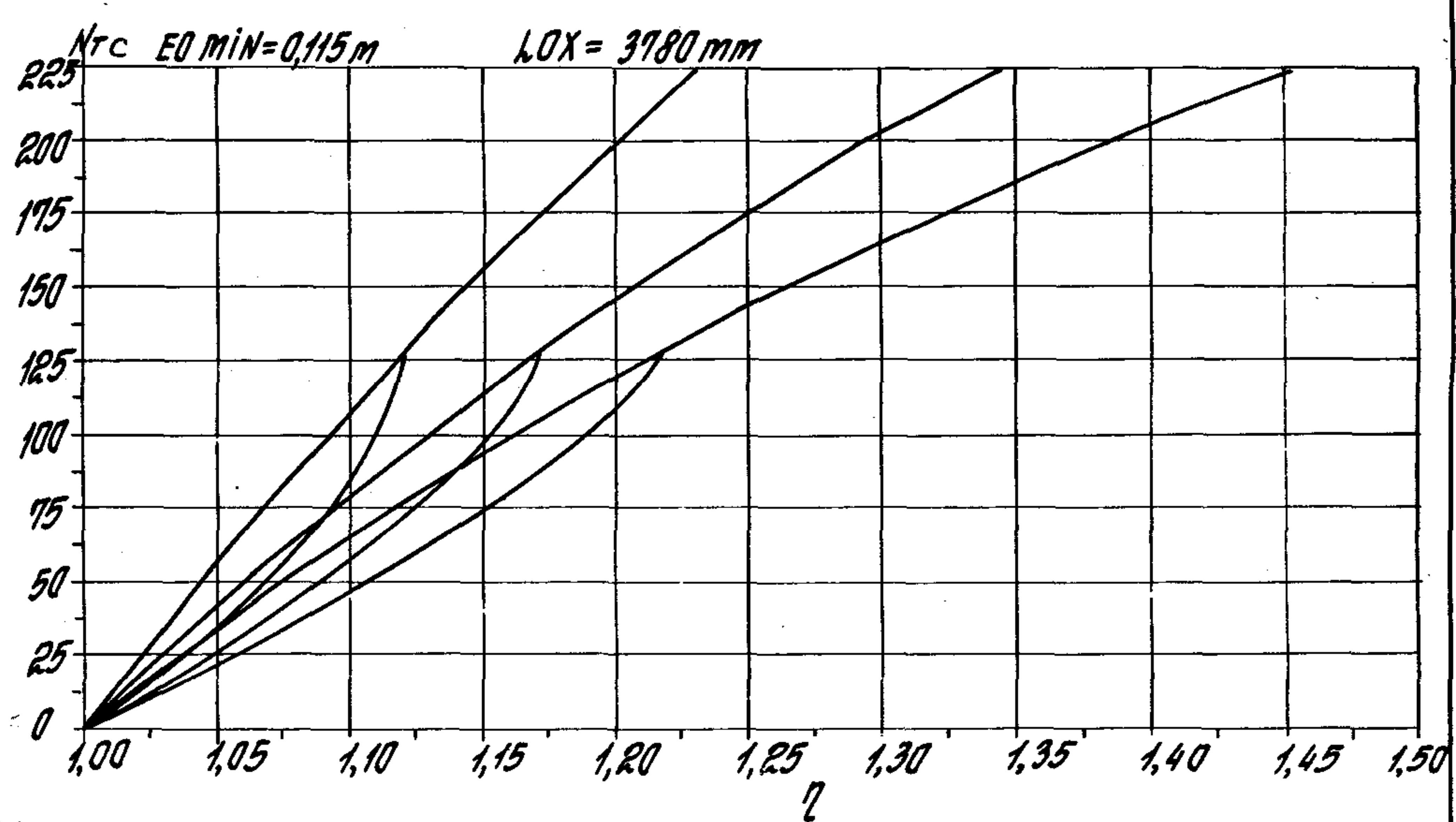
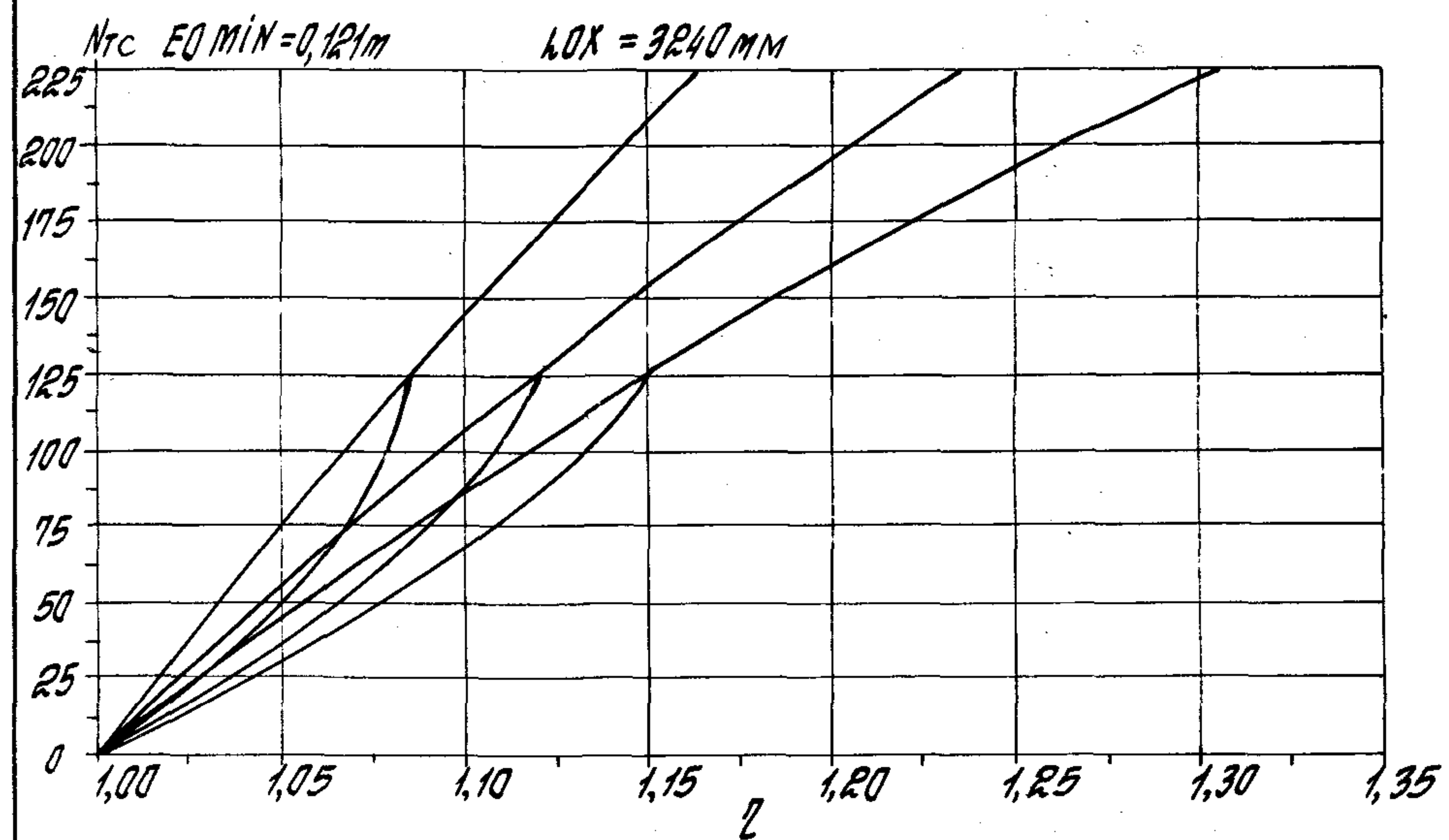

1.020.1-4 0-9 002 AUCT
54

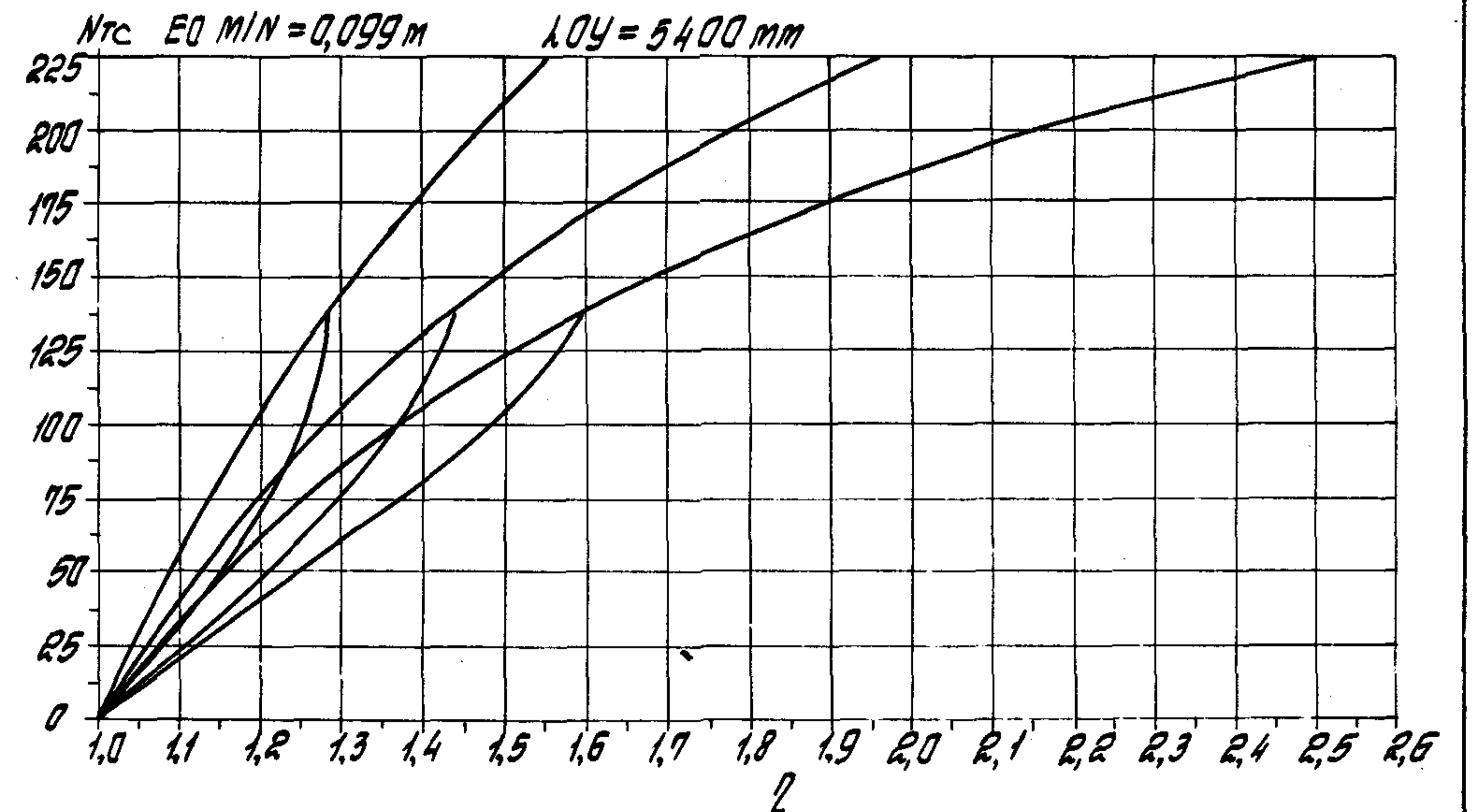
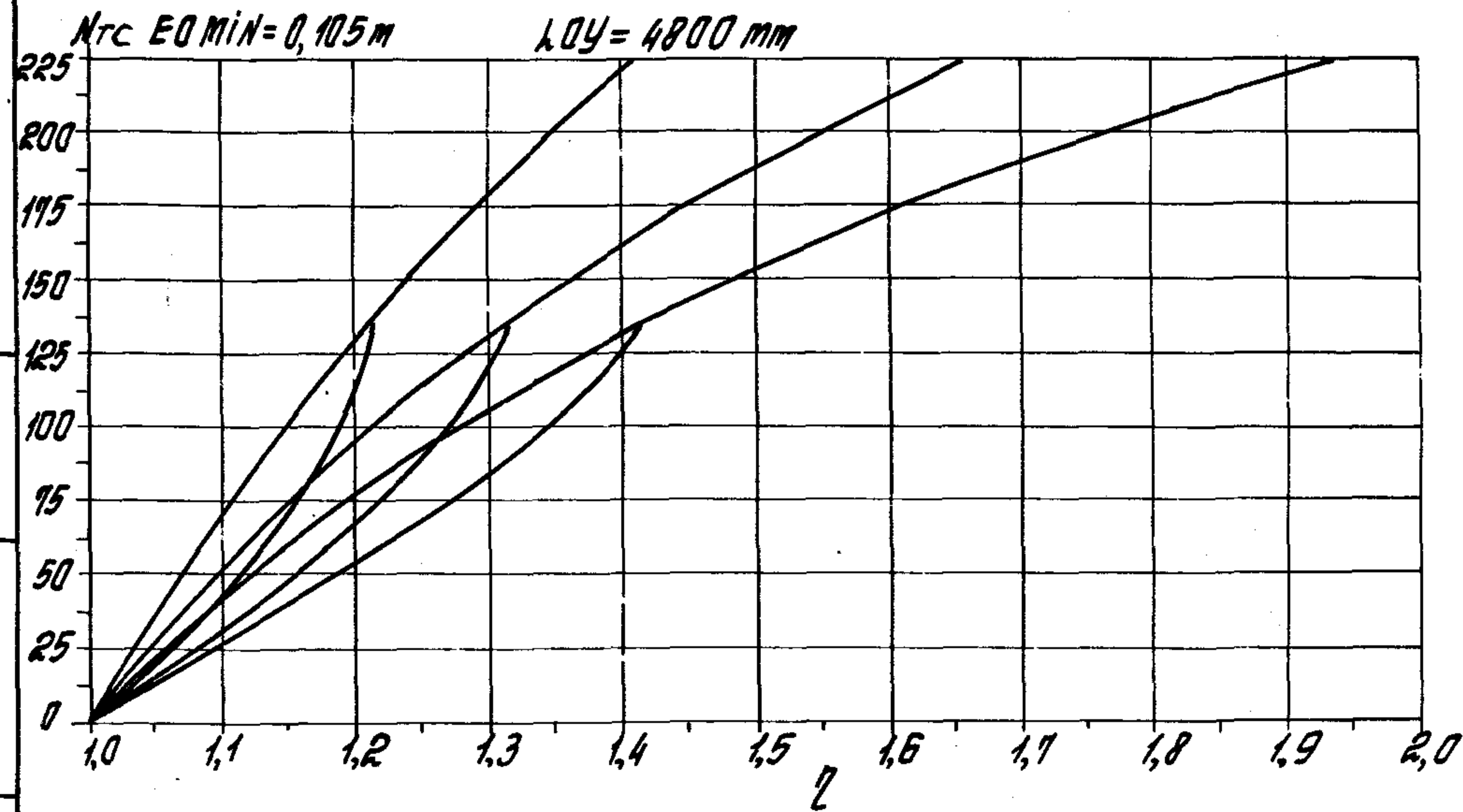
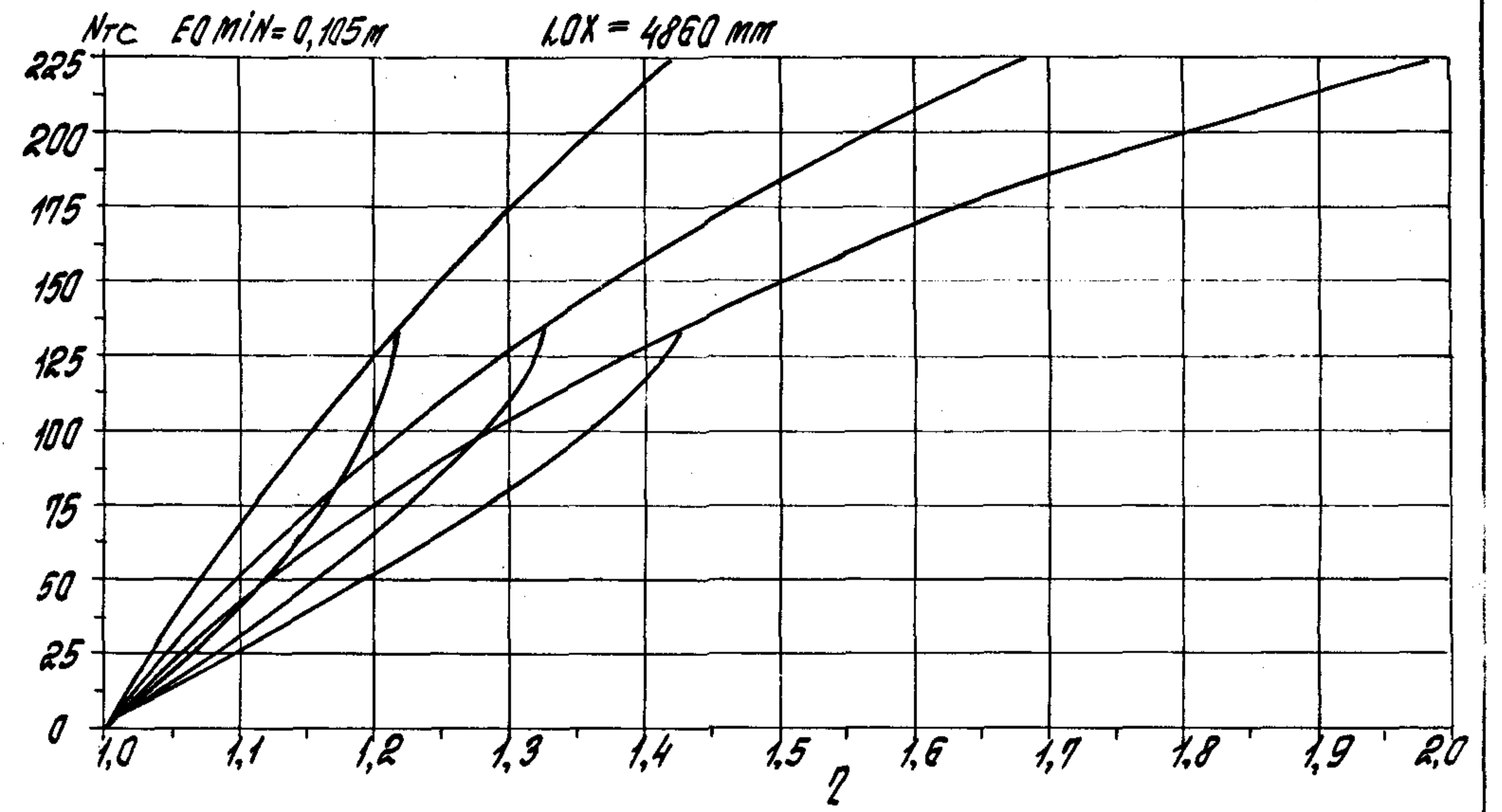
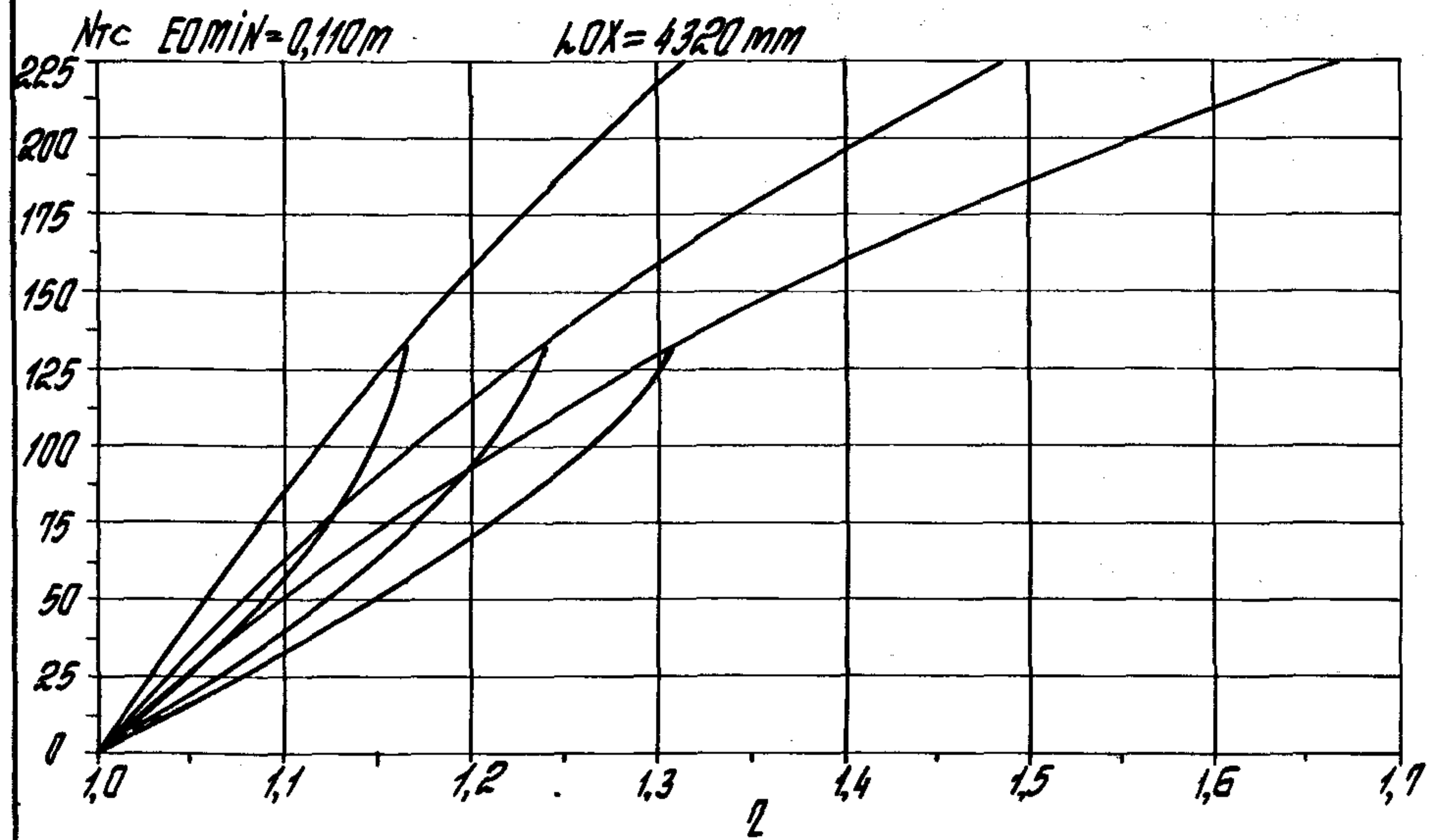

1.020.1-4 0-9 002

1.020.1-4 0-9 002 L_{OCM}
55

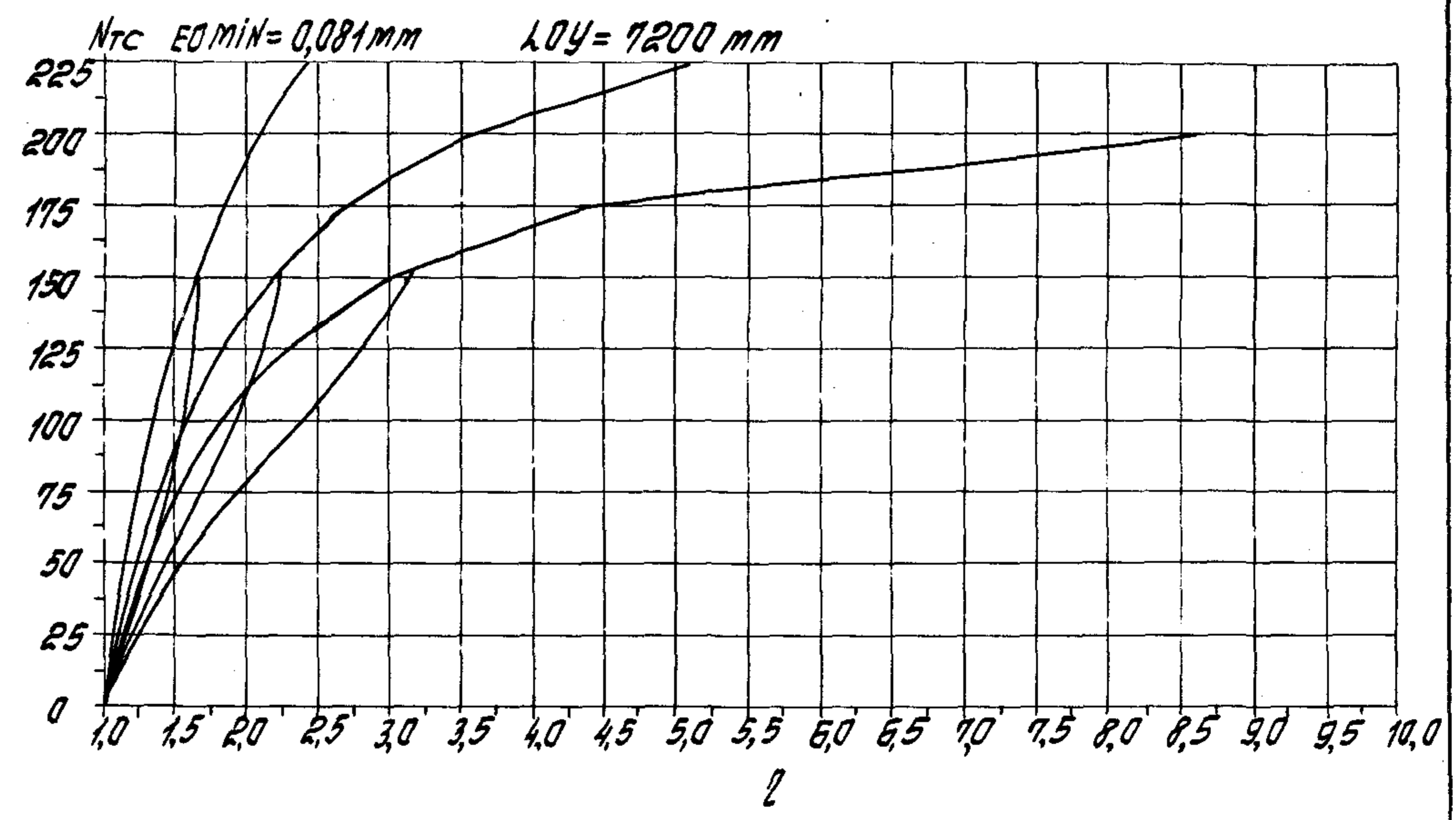
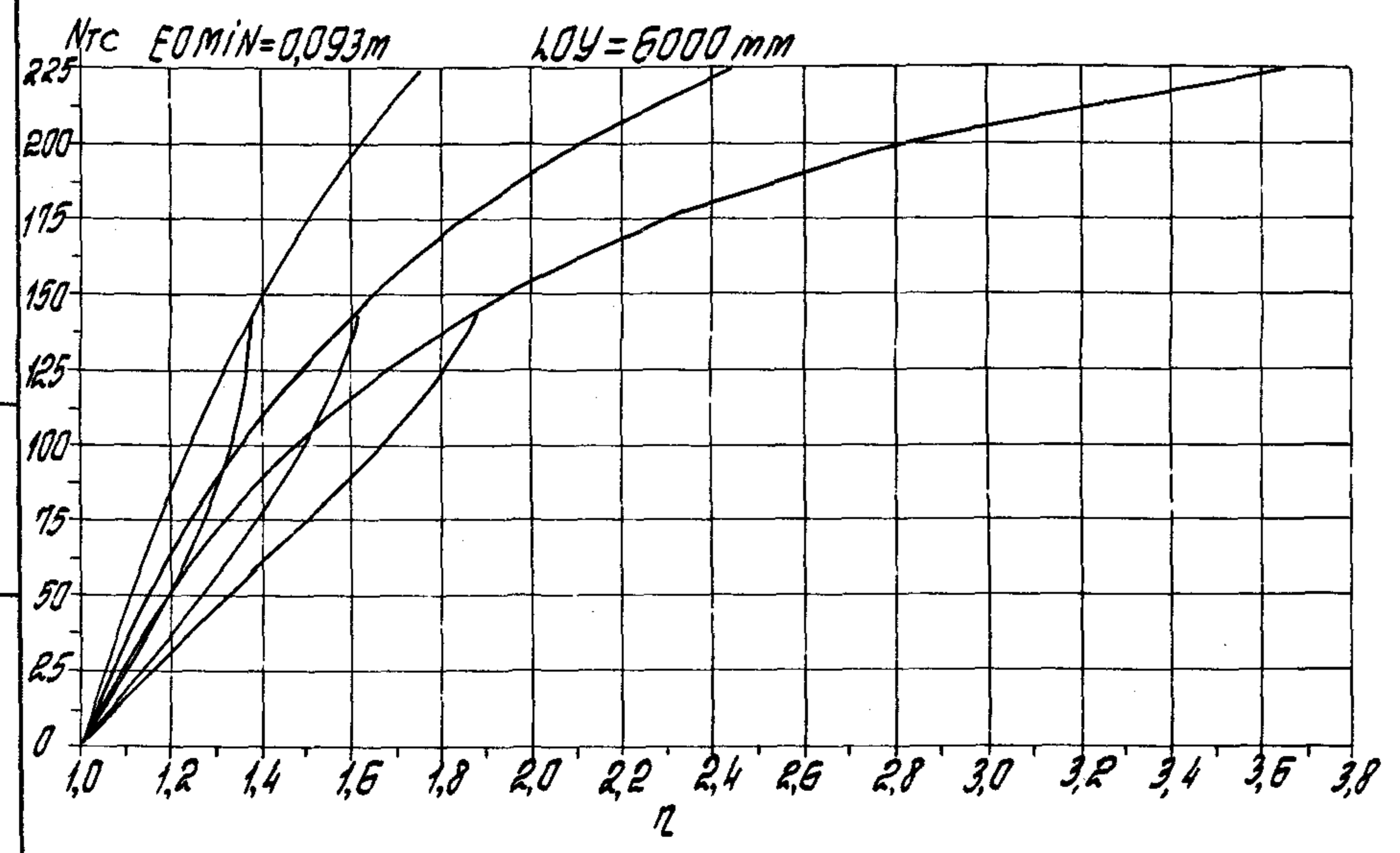
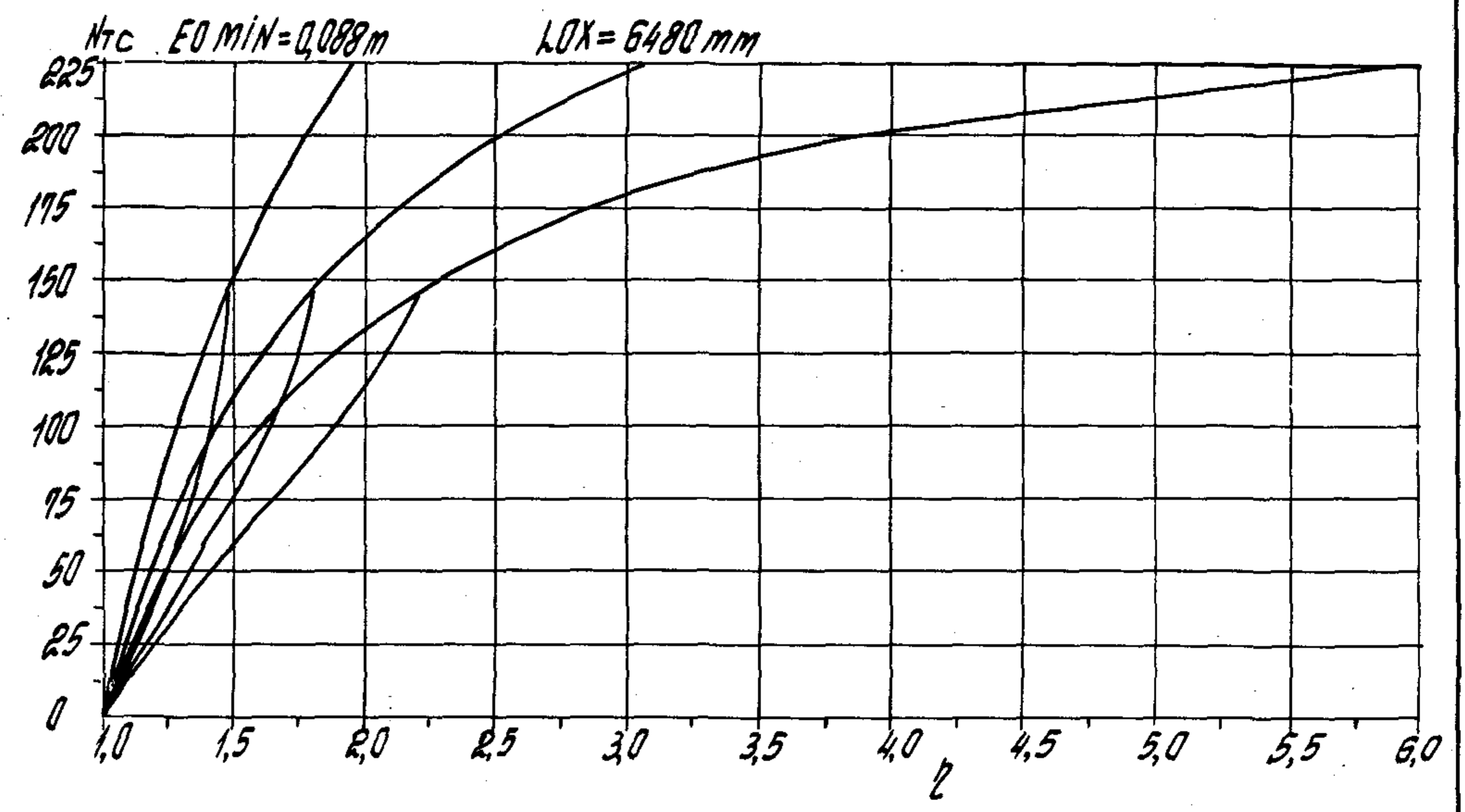
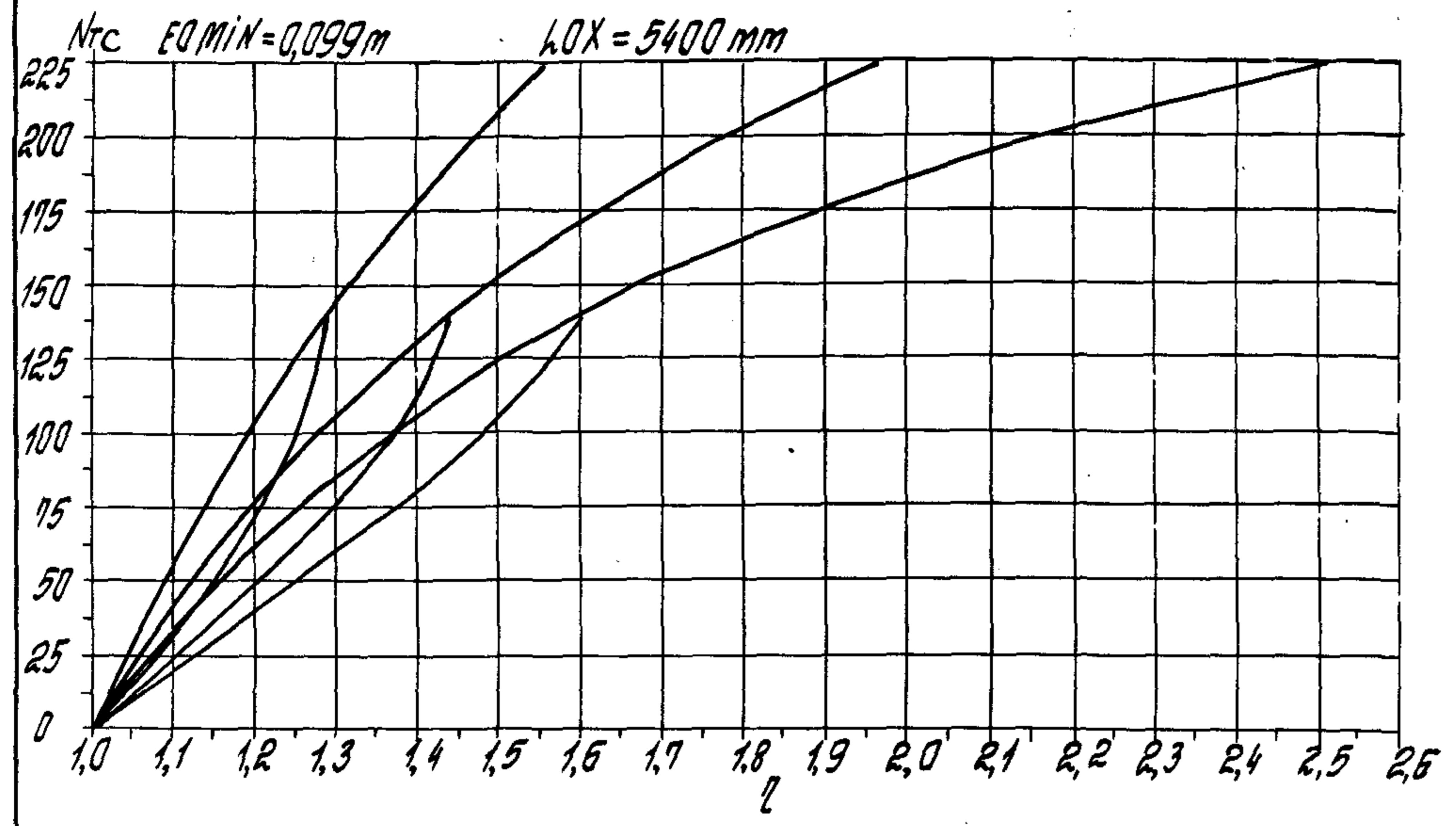

ДИП. № 0000. УЧОБНИК. № 0000. УЧОБНИК. № 0000. УЧОБНИК. № 0000.

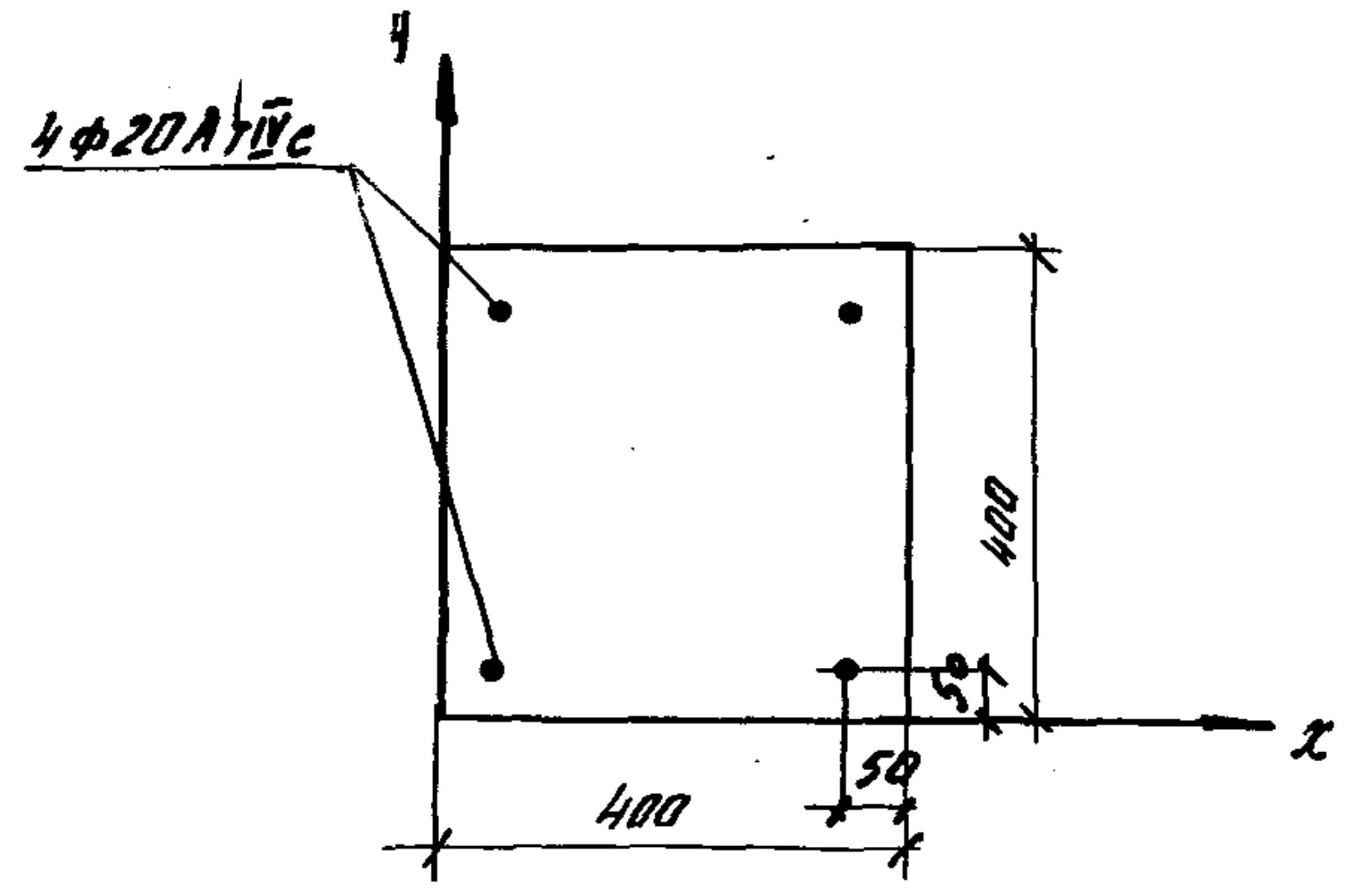
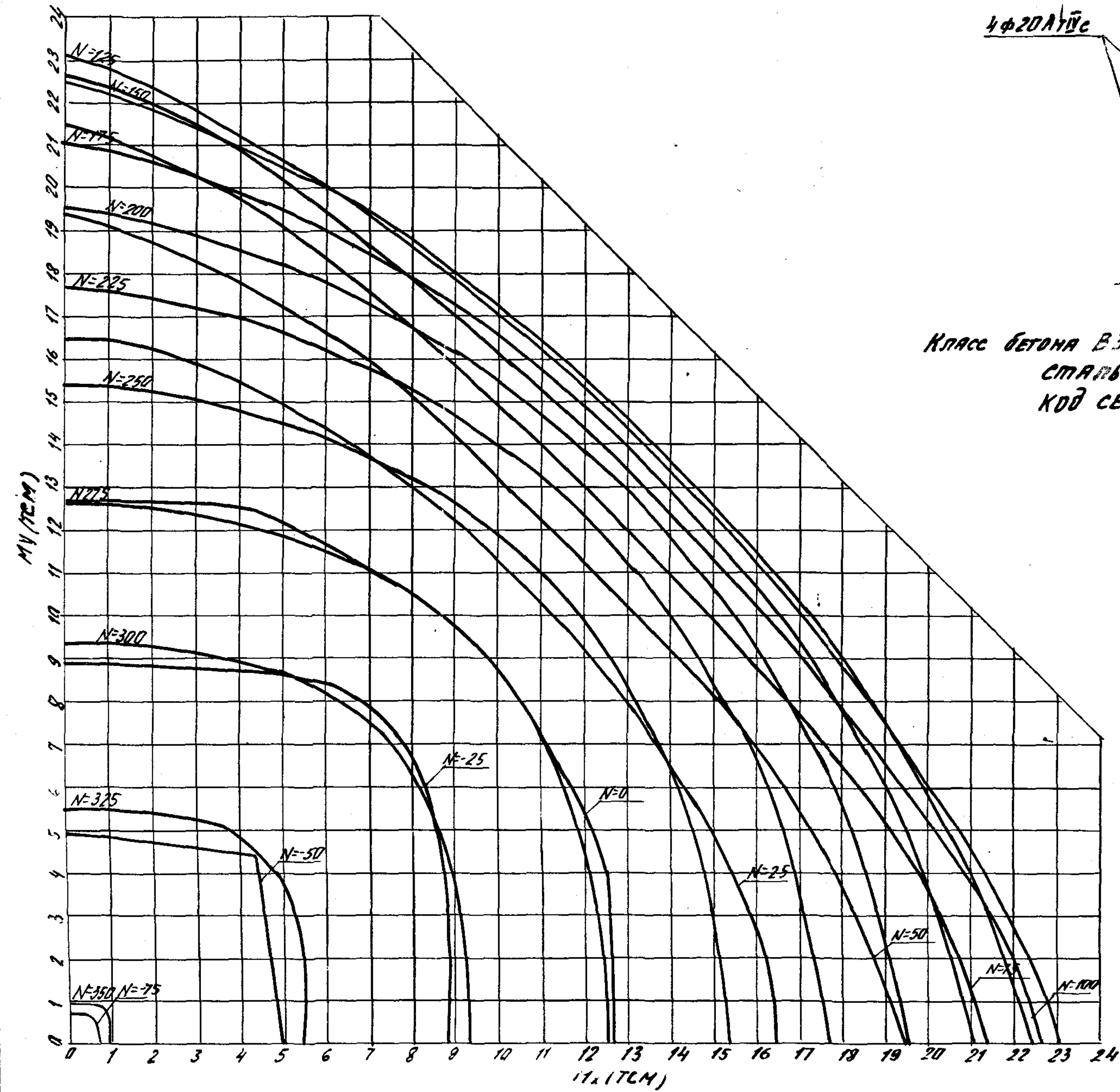

Класс бетона В300 ($R_b = 18.7 \text{ МПа}$ при учете $\gamma_{b2} = 1.10$)
 сталь АТ-11с
 код сечения - 108а

УИВ. АР. ПОДП. / Инженер УИВ. АР. / 2010. 01. 02

1.020.1-4 0-9 002
 59

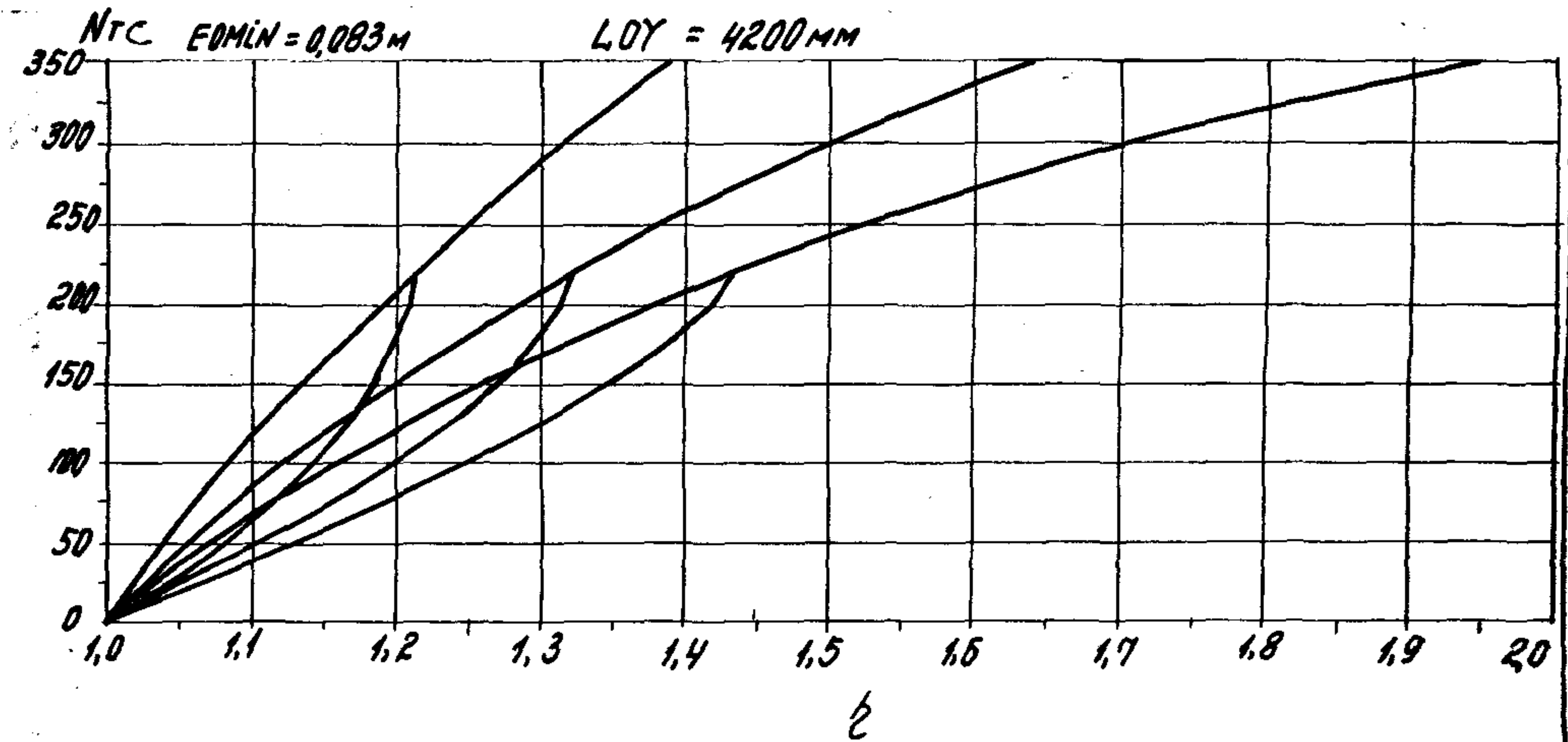
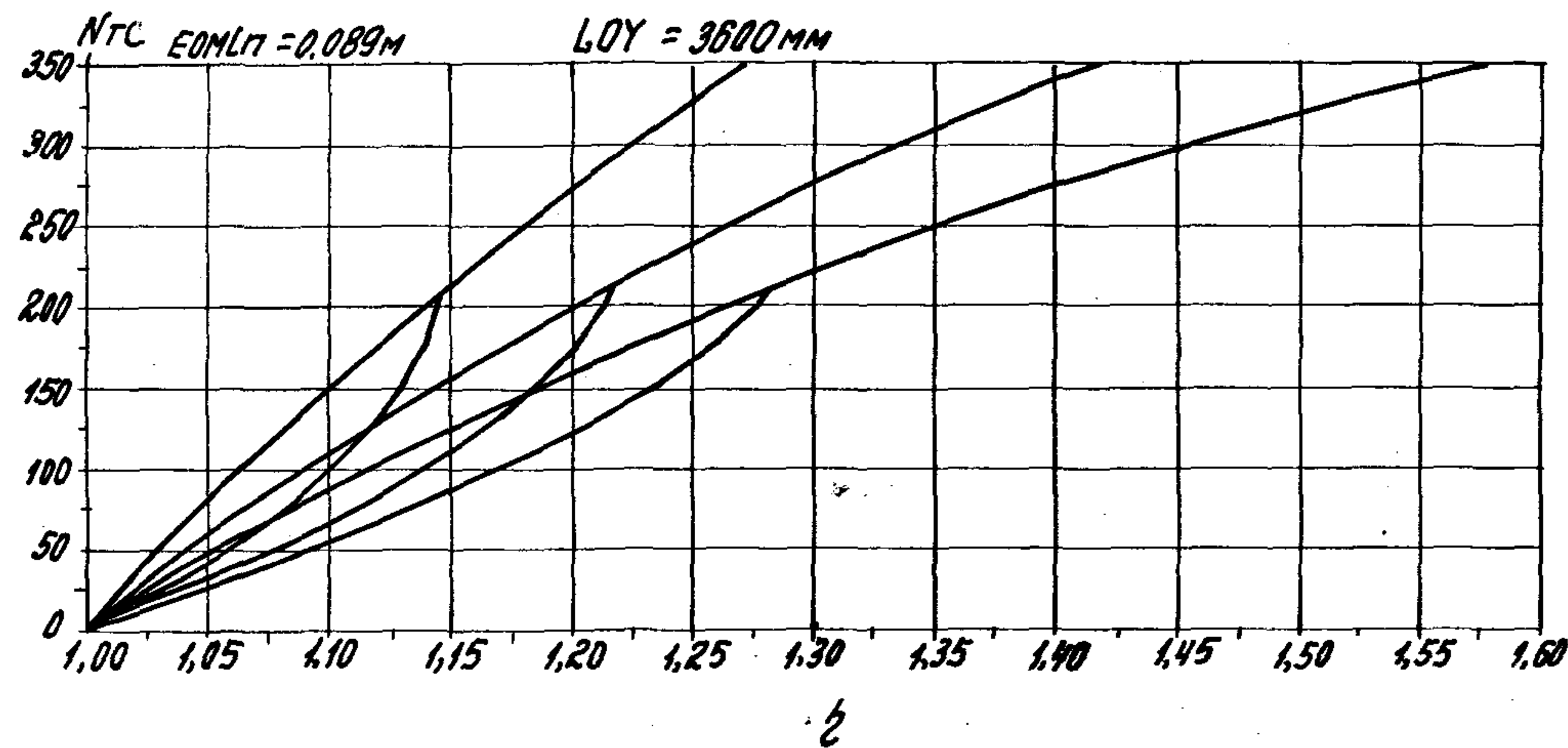
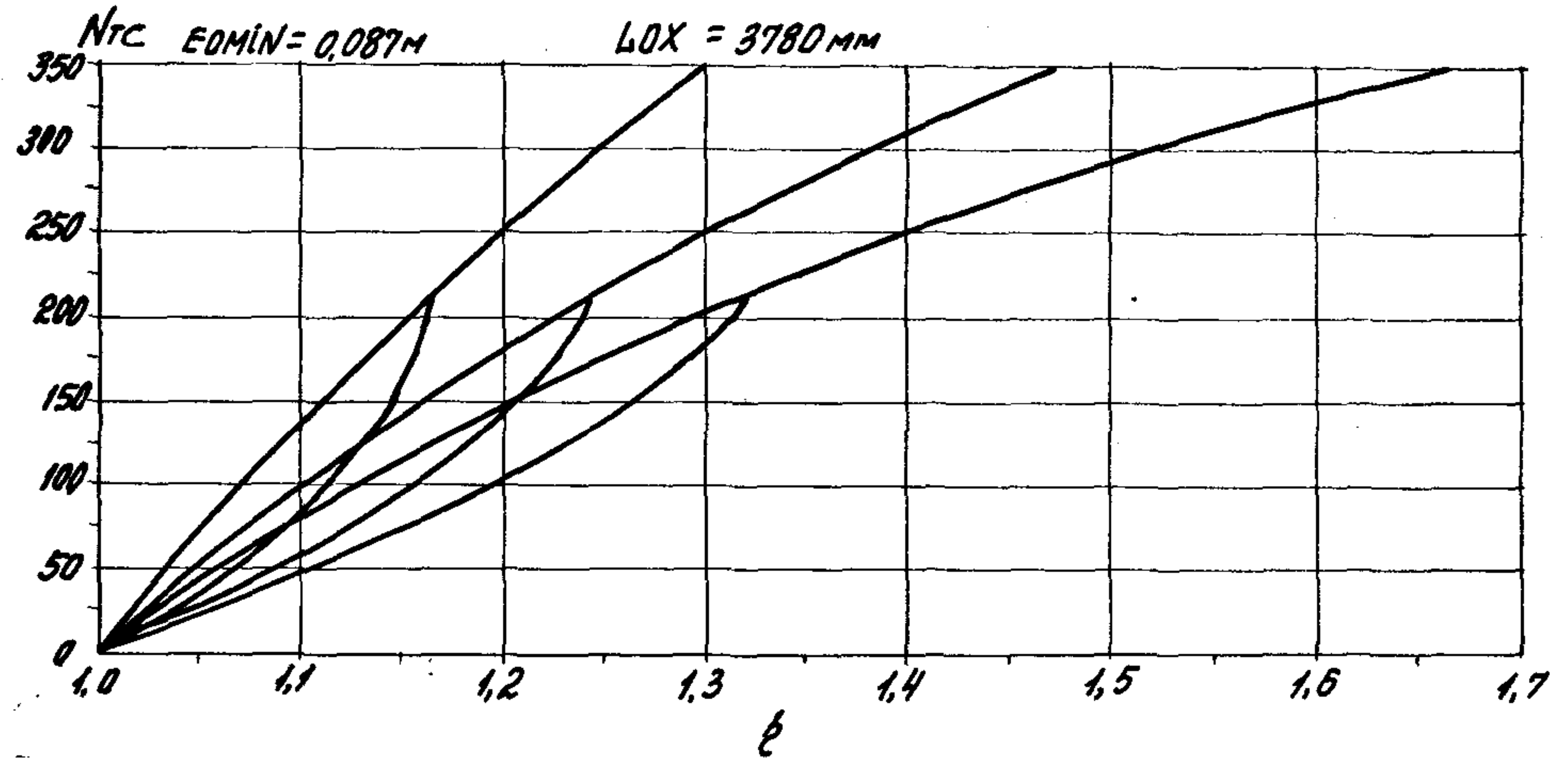
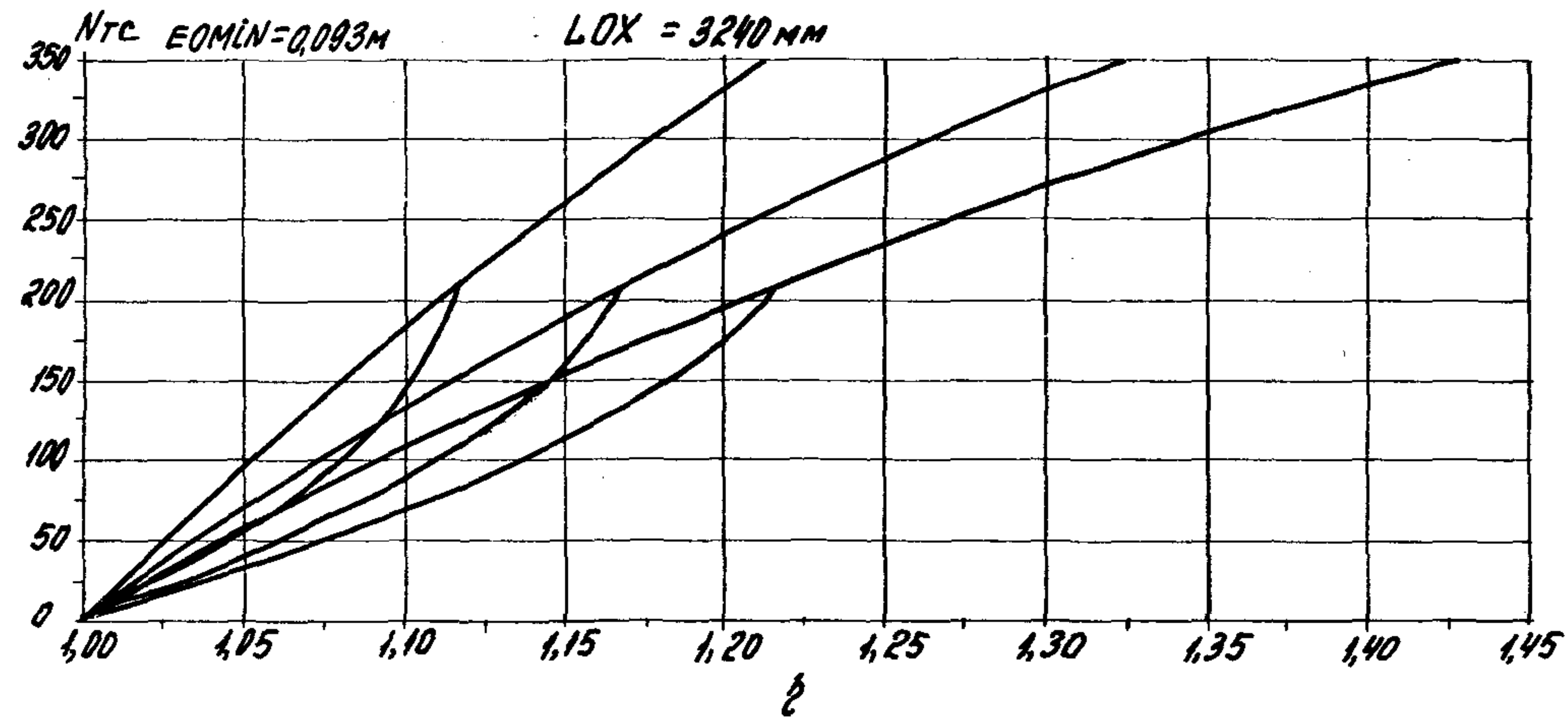

1.020. 1-4 0-3 002 58

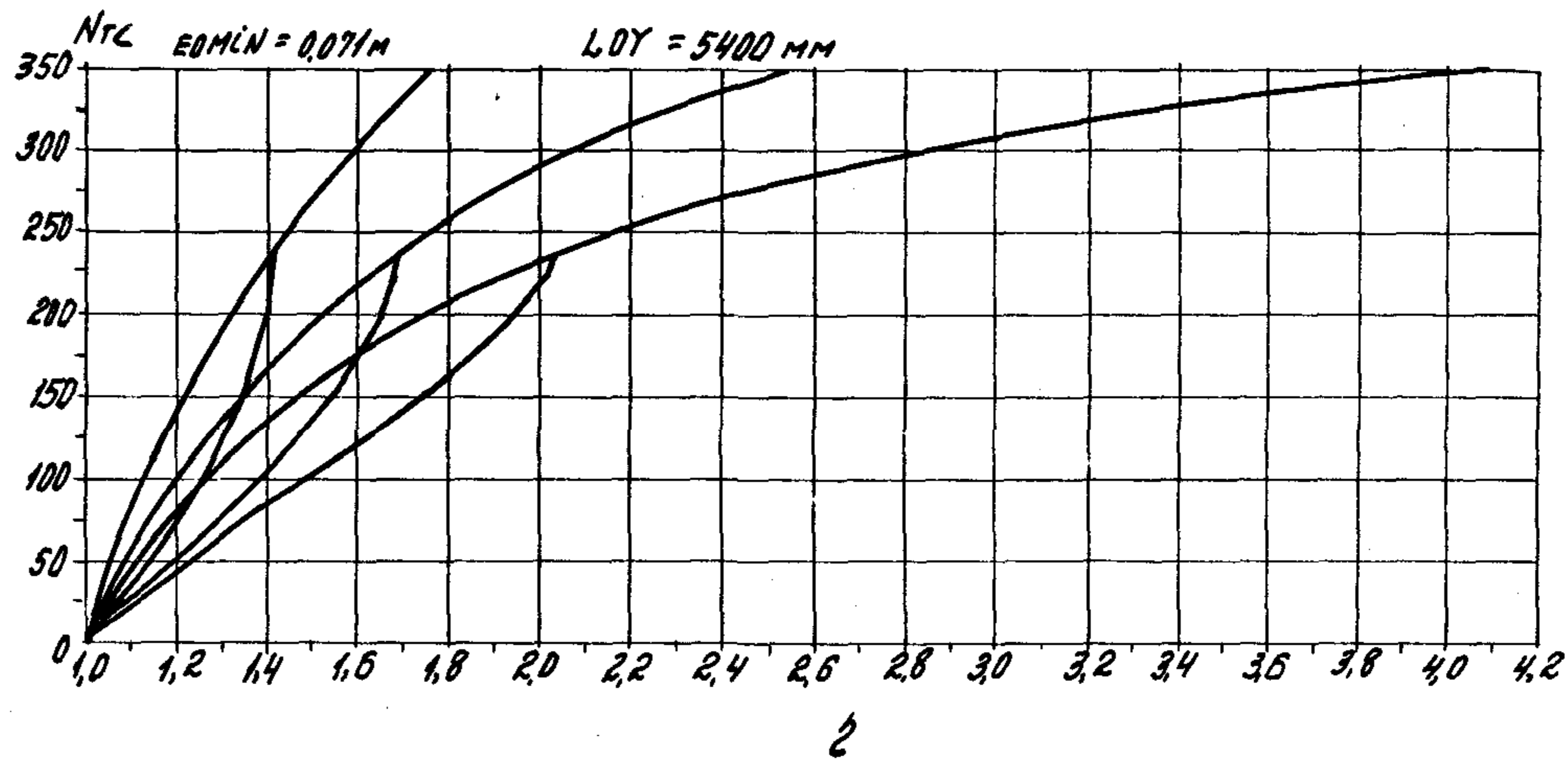
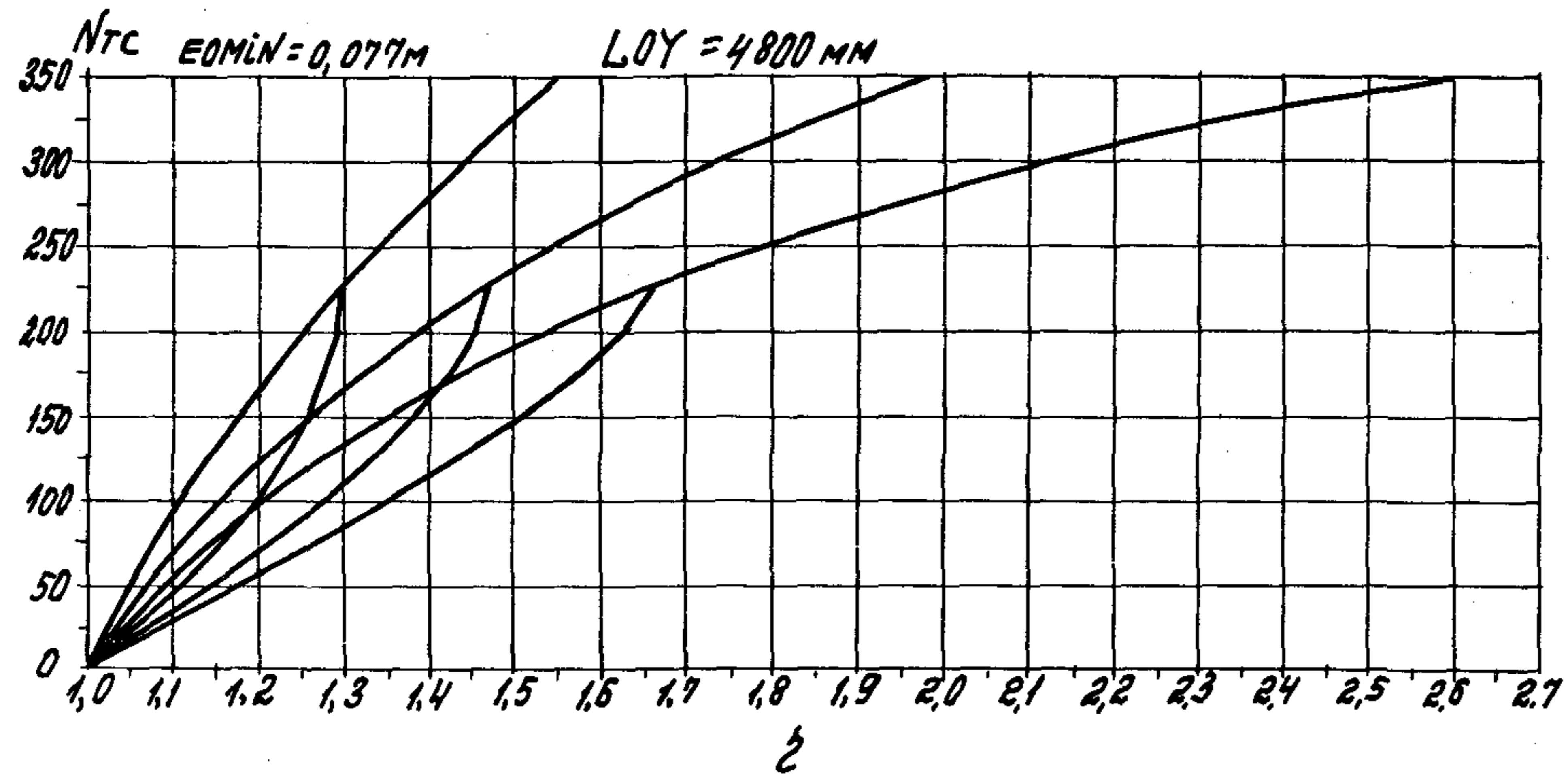
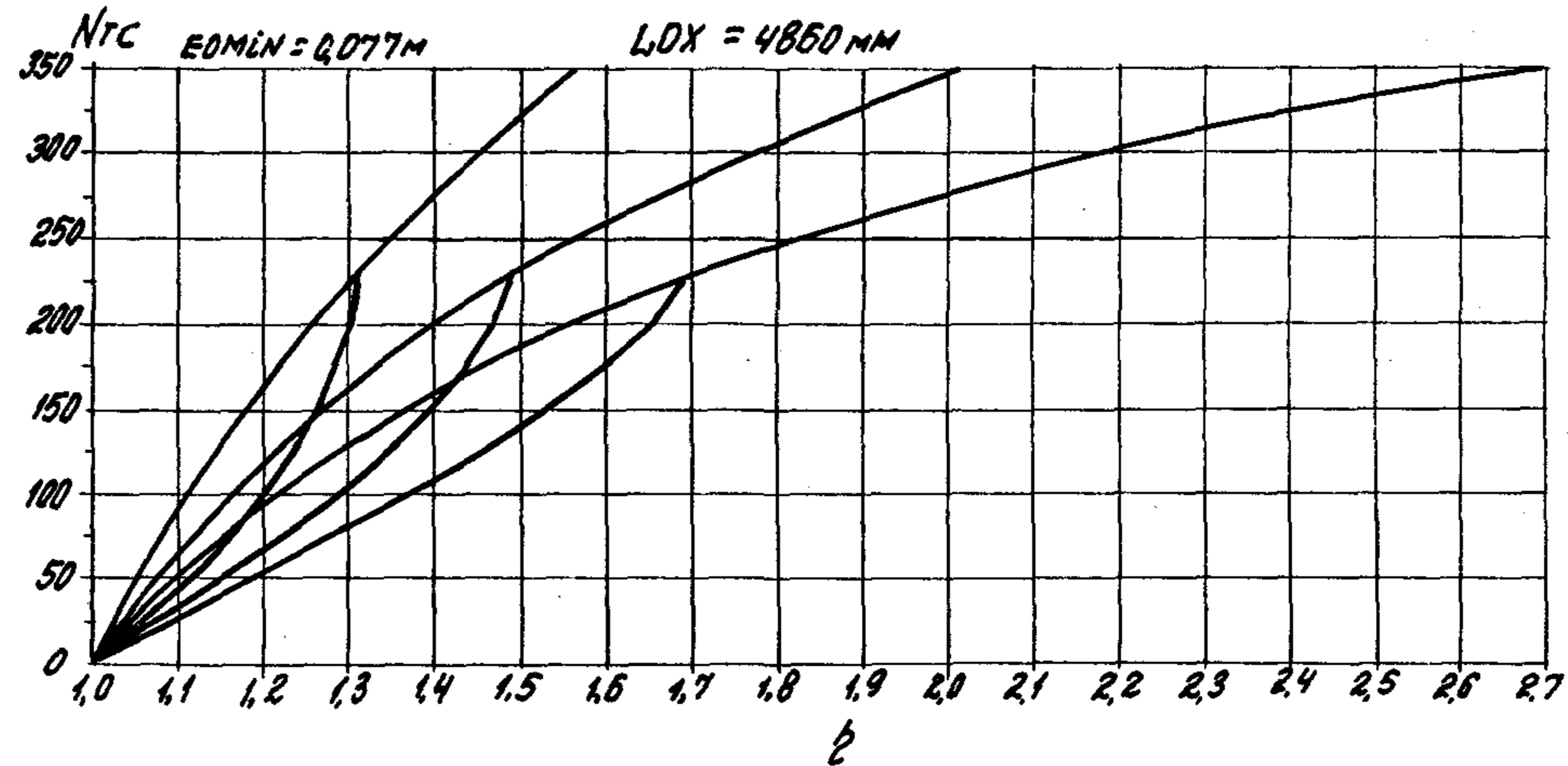
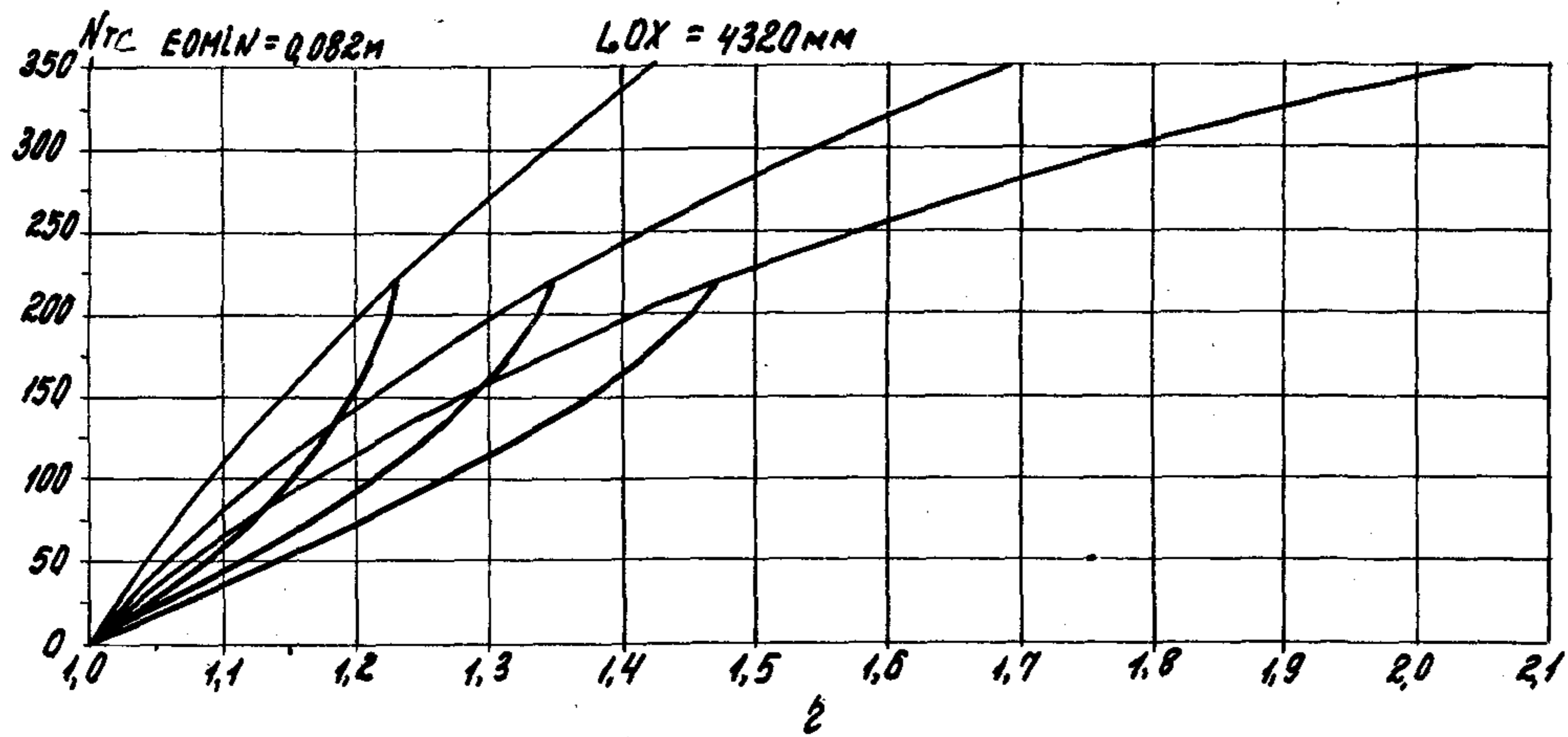

1.020.1-4 0-9 002 Лист
59

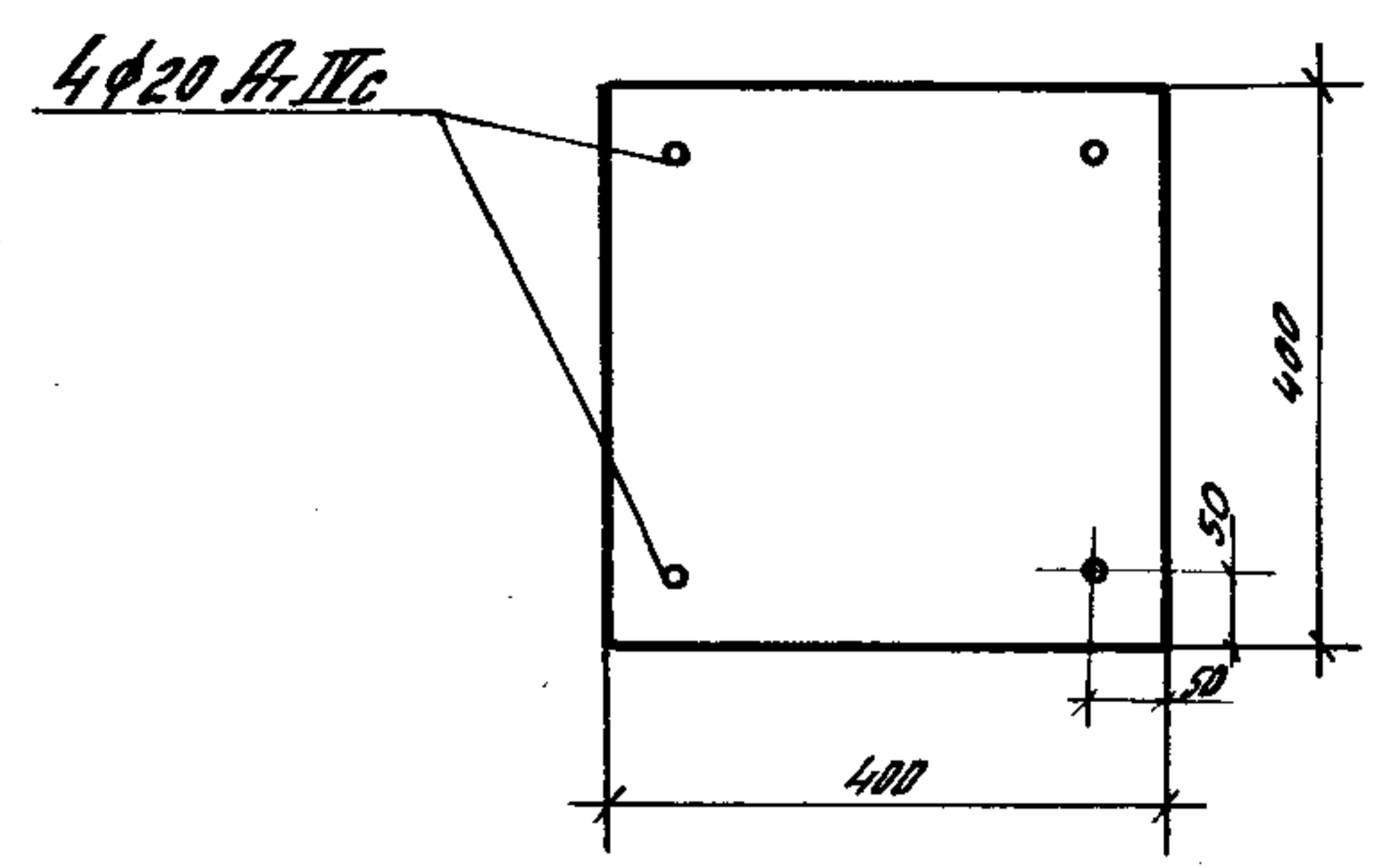
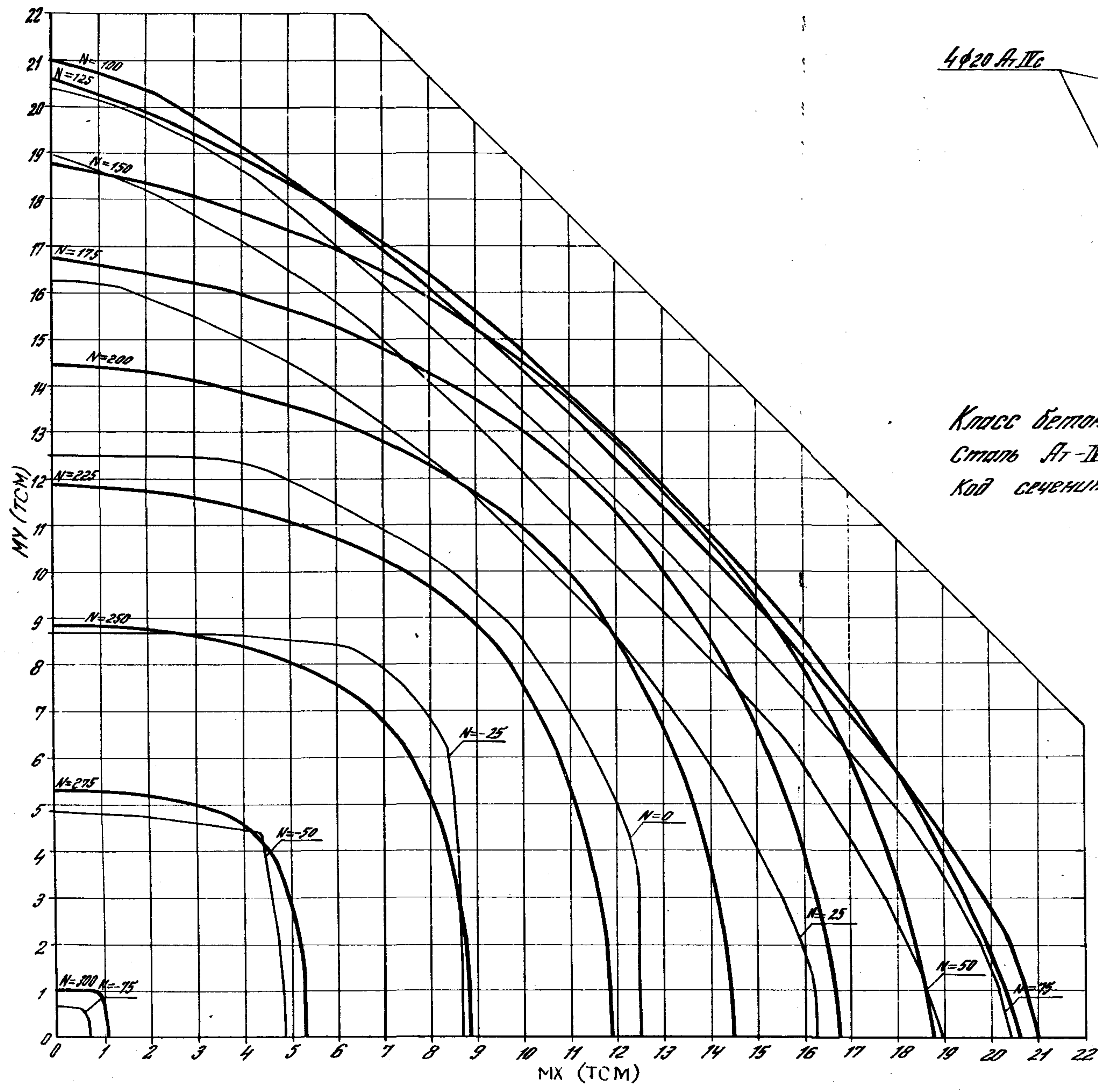

Класс бетона В30 ($R_b = 15.3$ МПа при учете $\gamma_{b2} = 0.90$)
 Сталь А-IIIc
 Код сечения -108δ

Инст. № 1001/1
 Подпись и печать
 Дата: 10.01.11

1.020.1-4 0-9 1002 Лист 61

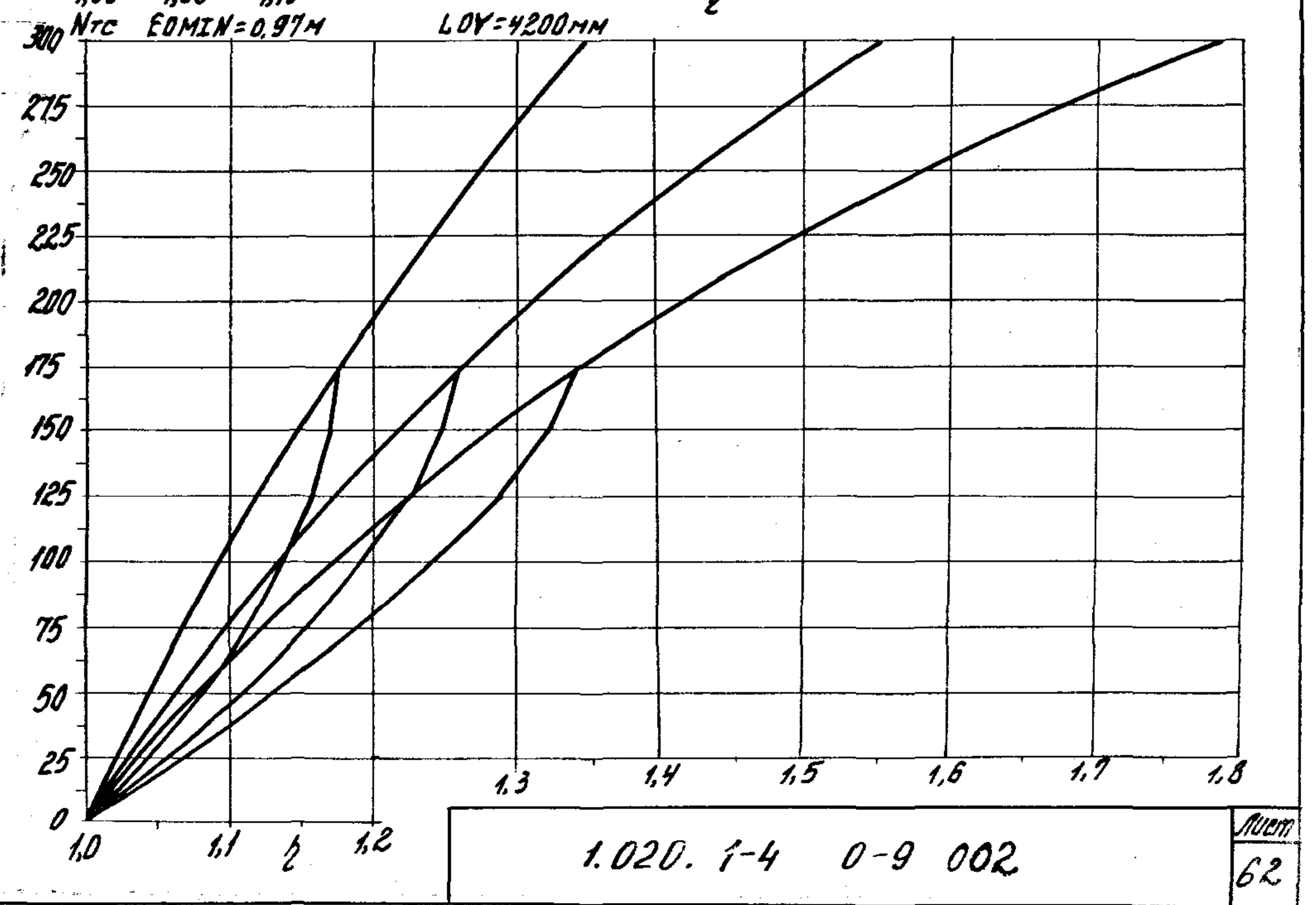
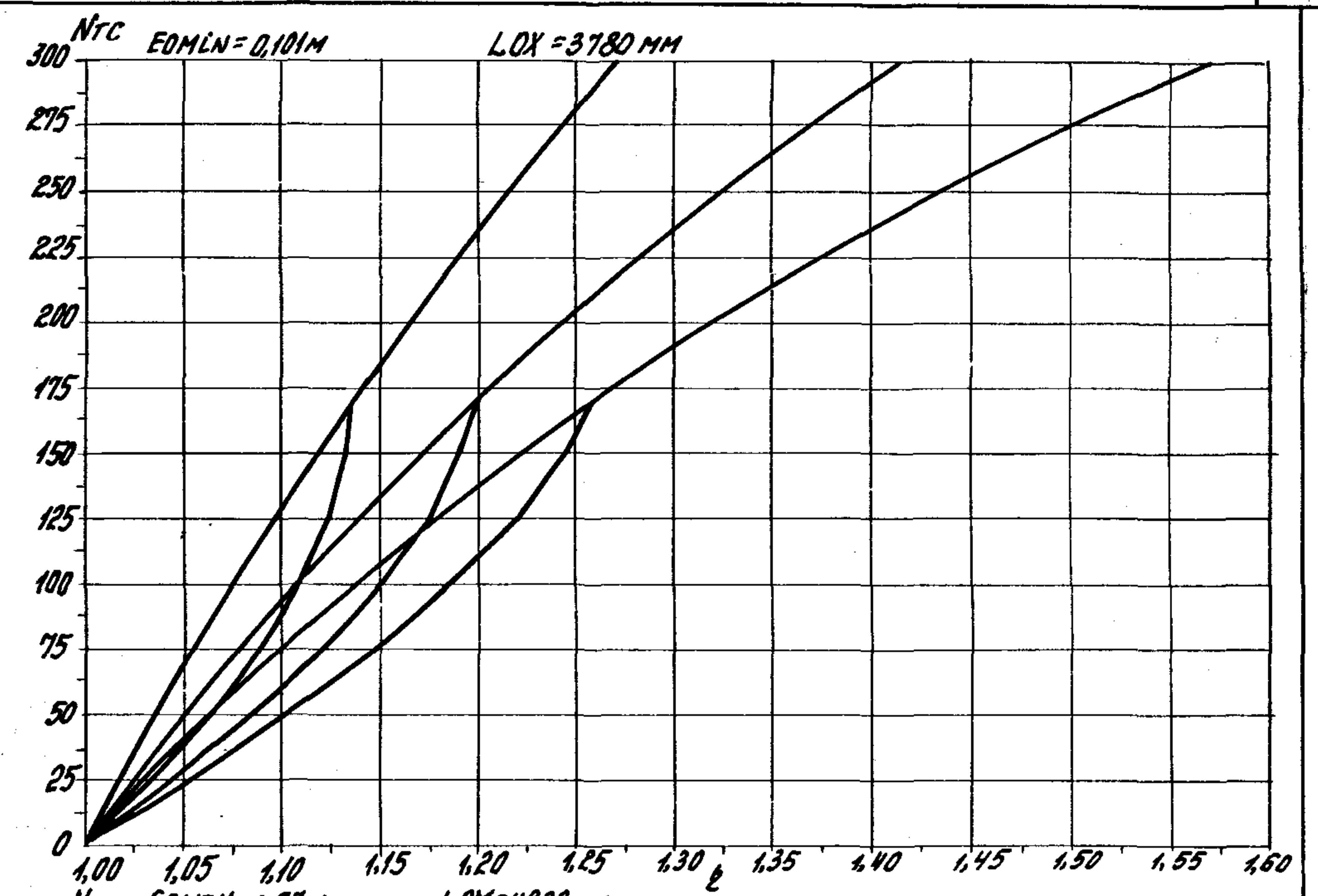
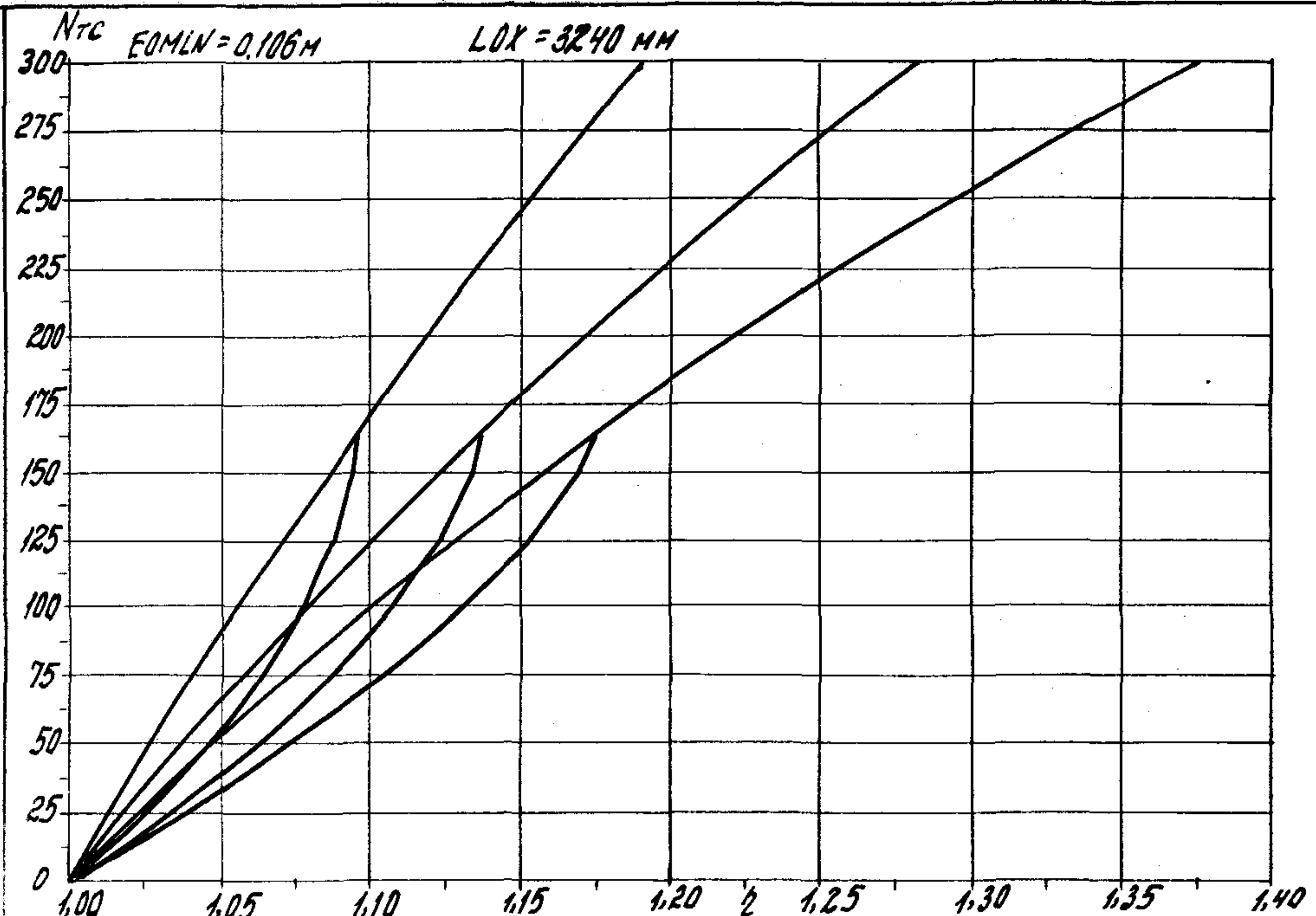

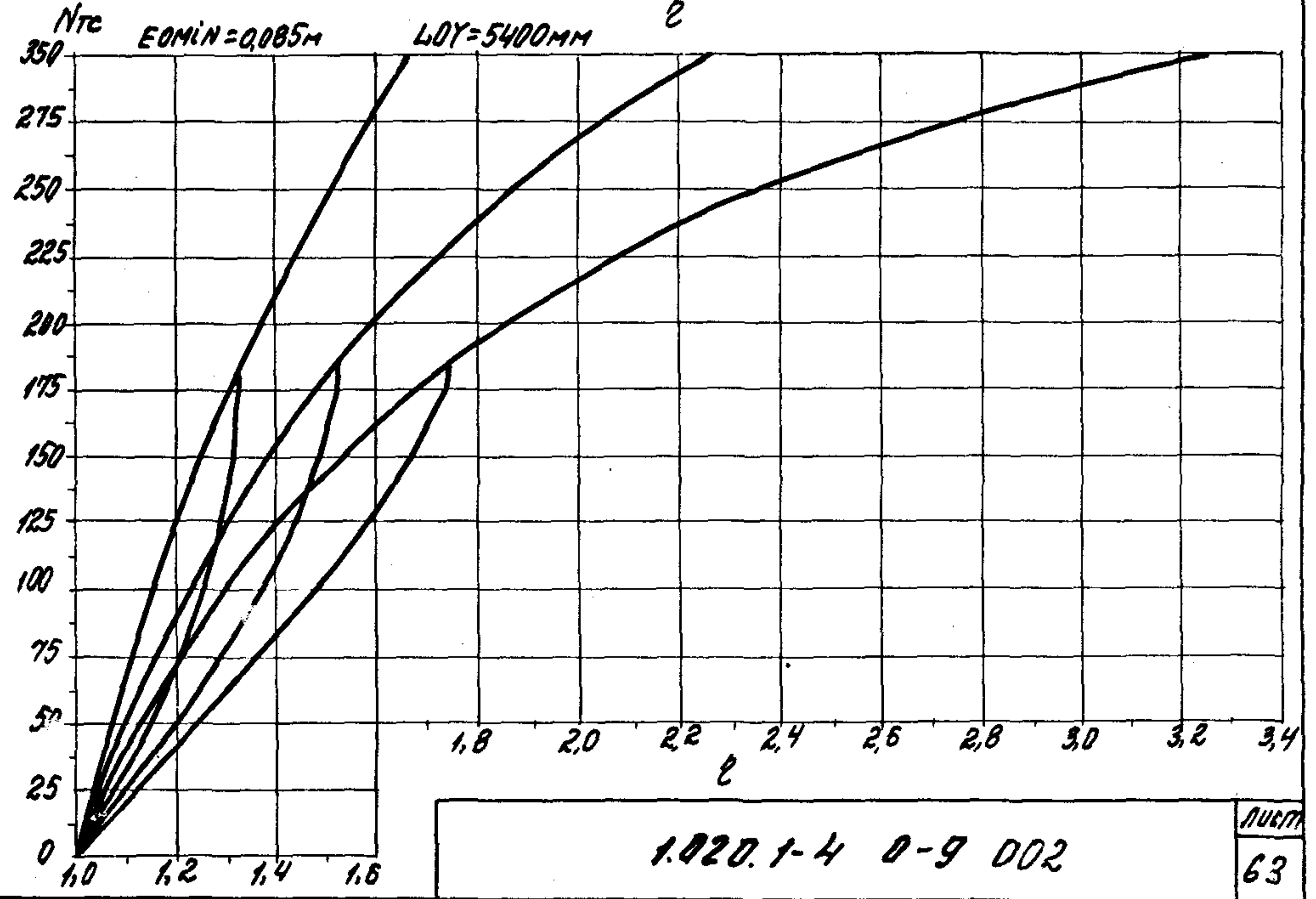
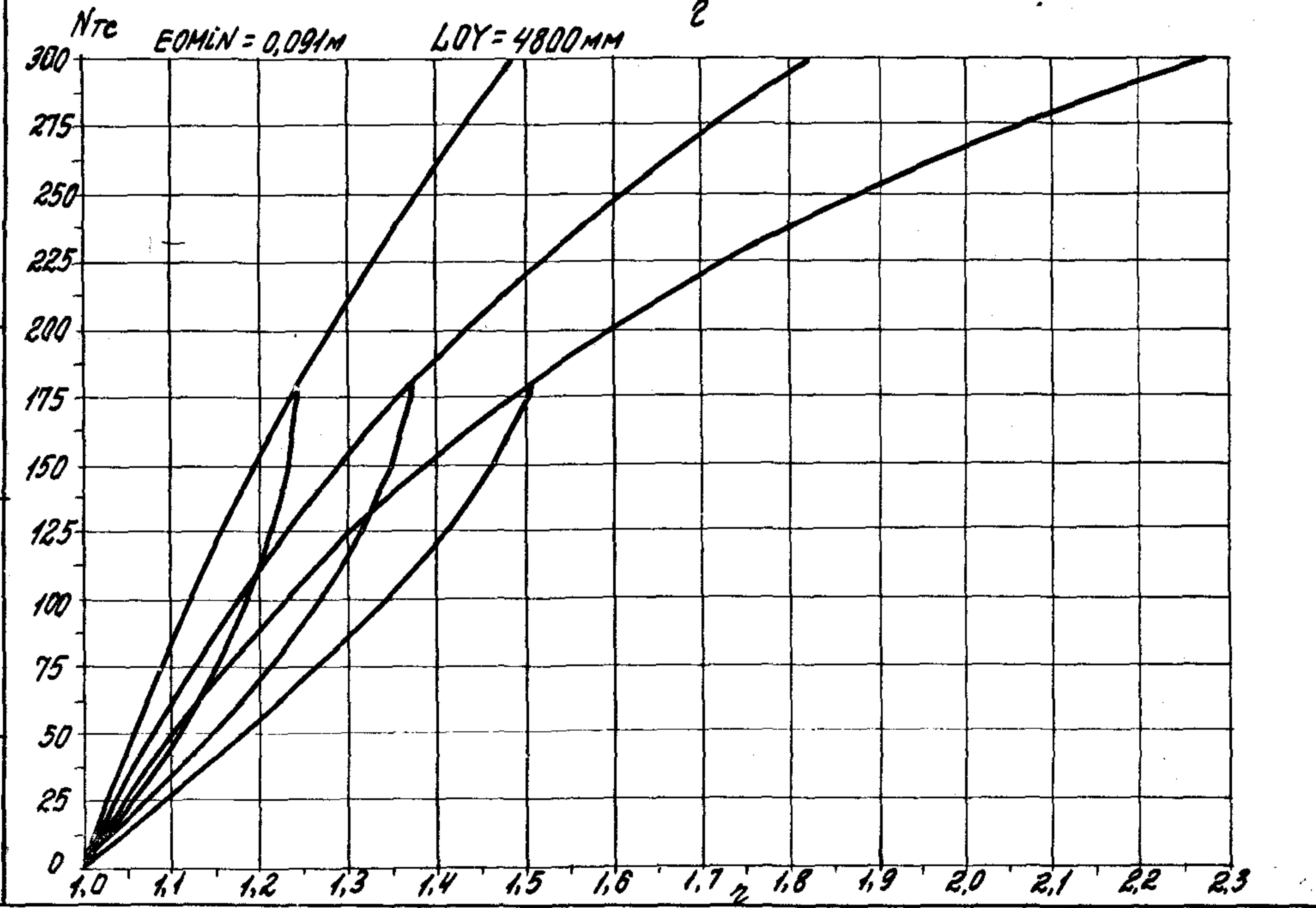
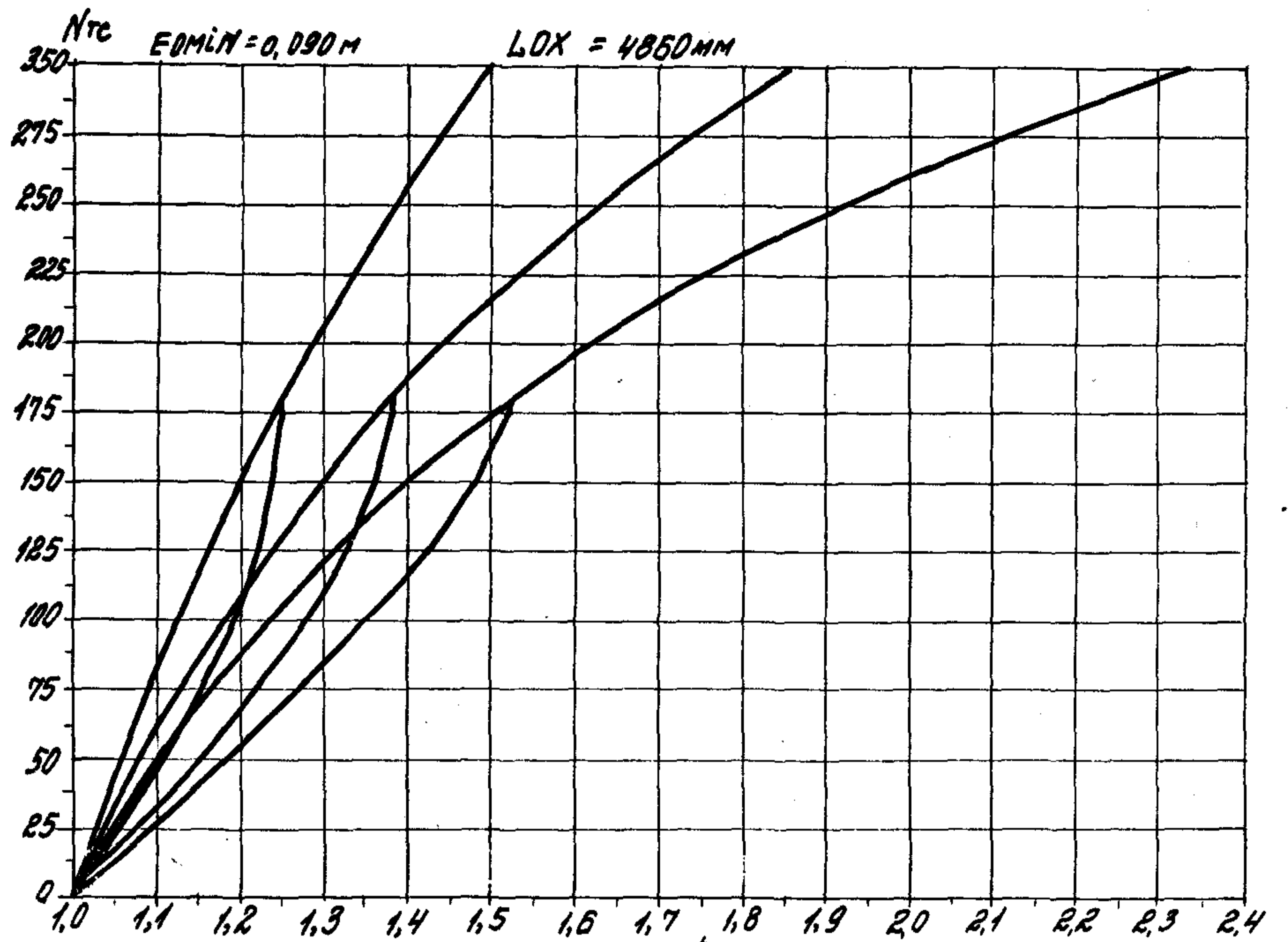
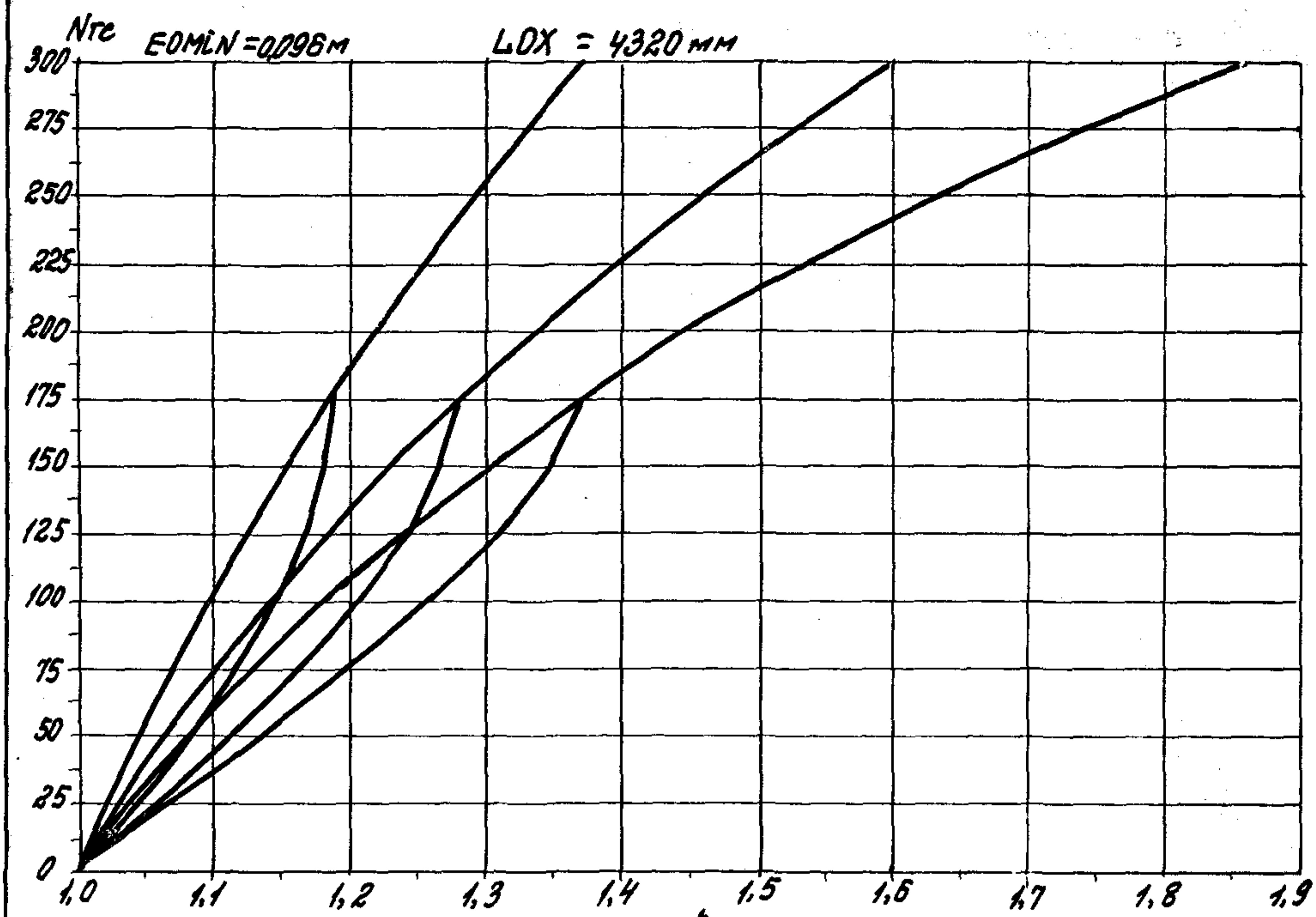

1.020.1-4 0-9 002

Лист	63
------	----

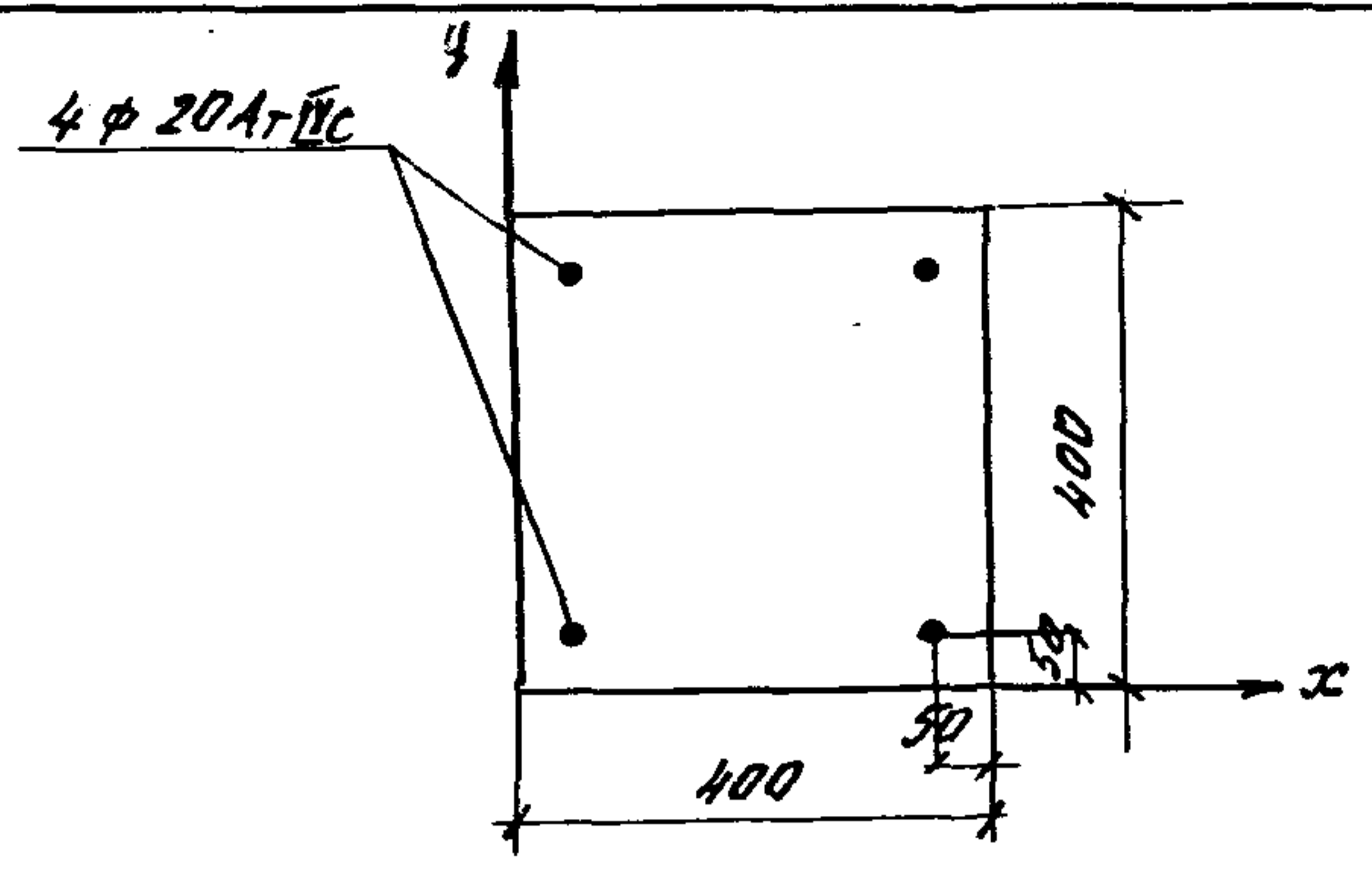
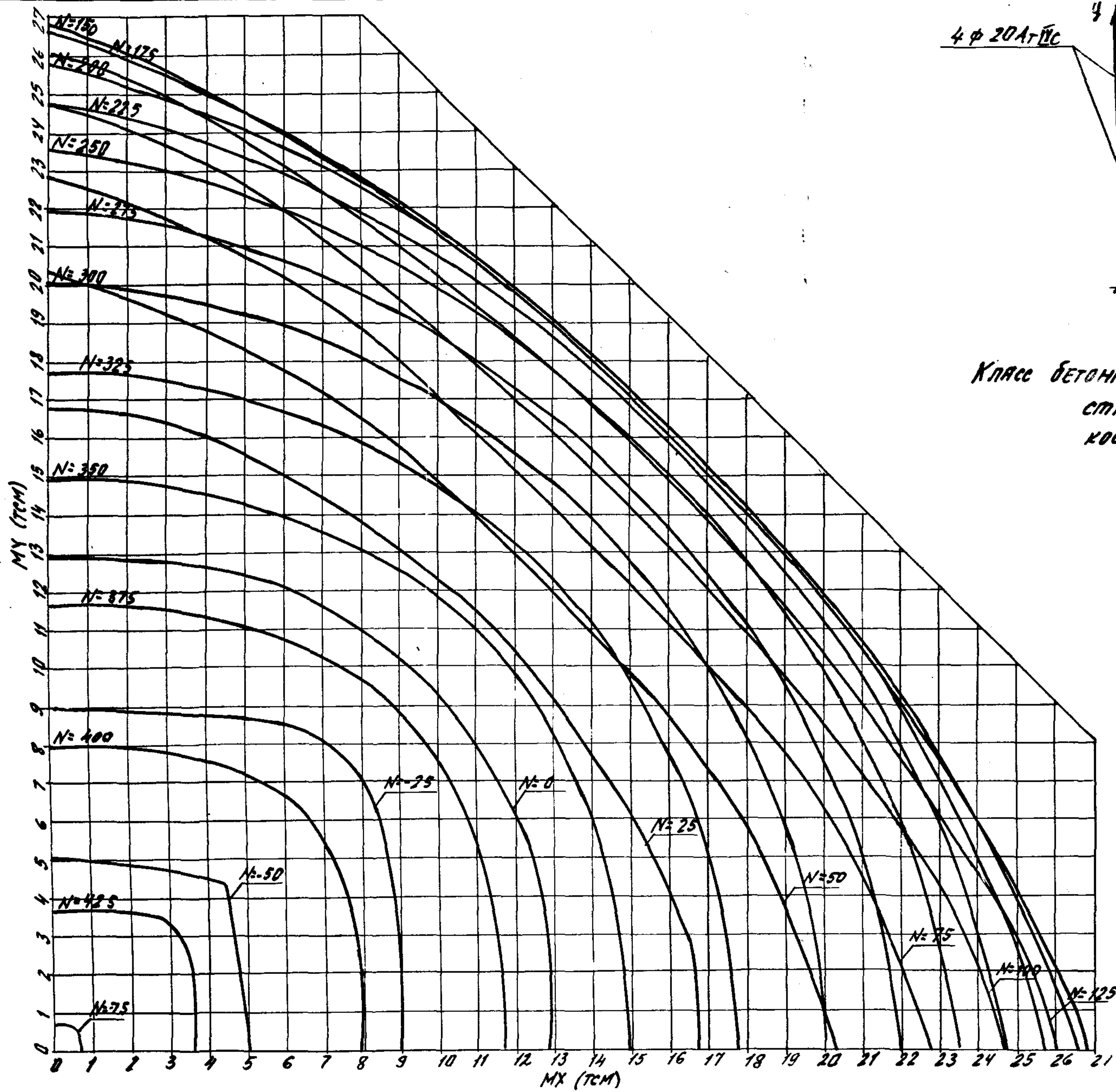

Класс бетона В40.0 ($R_b = 24.2$ МПа при учете $\gamma_{b2} = 1.10$)
 сталь АТ-ІІС
 код сечения - 109а

УИИ, № 10101, Подпись и дата
 Вывод 04.08.19

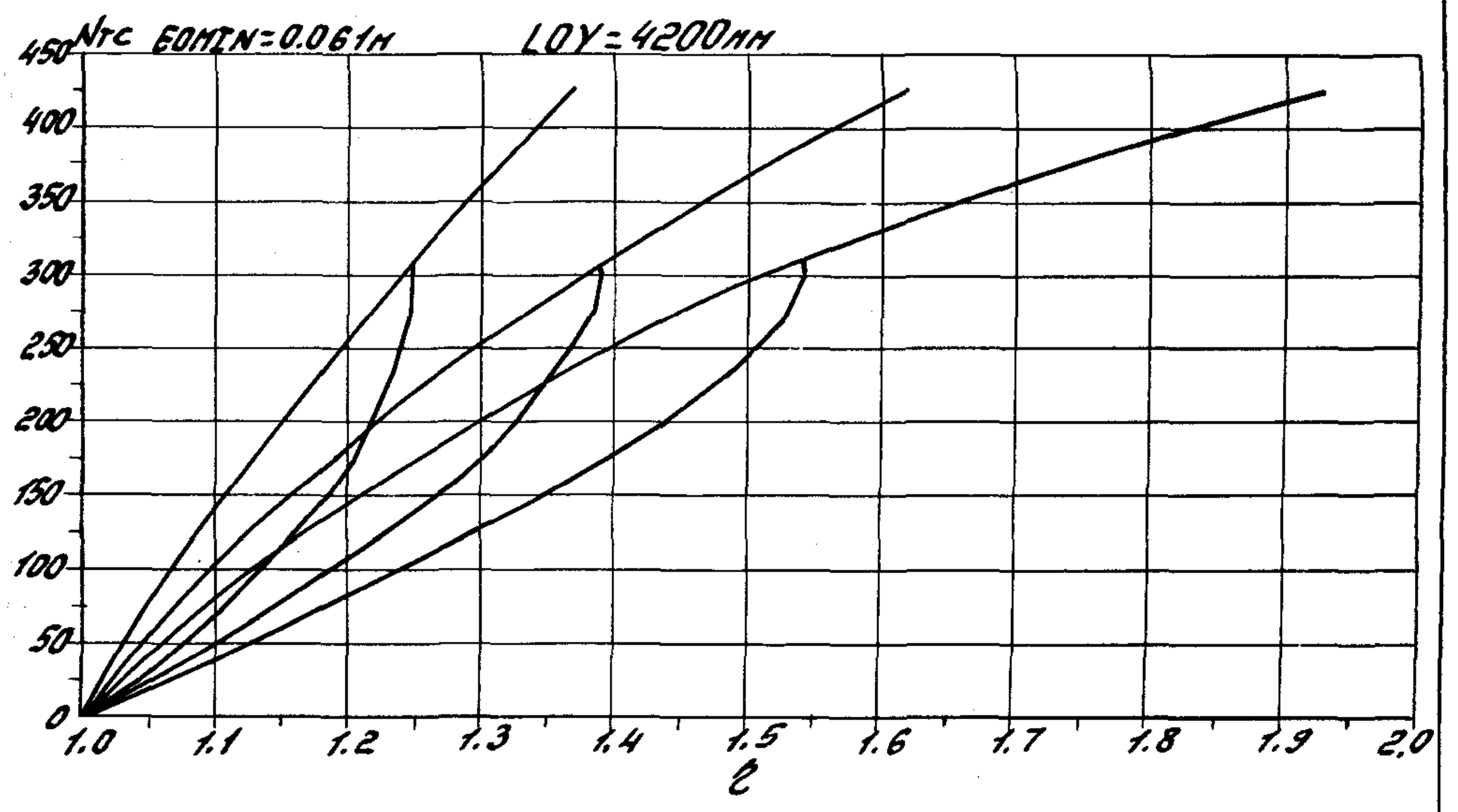
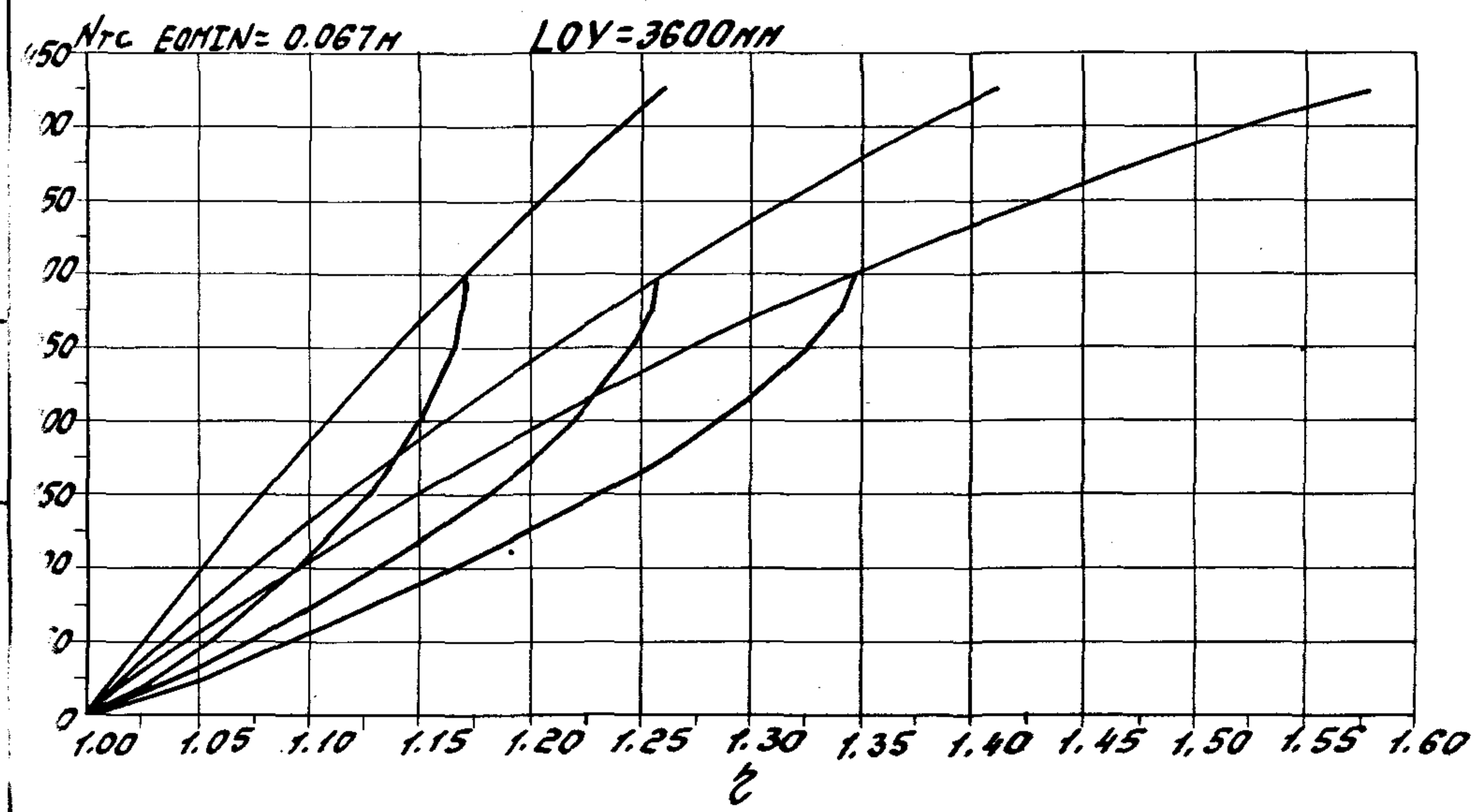
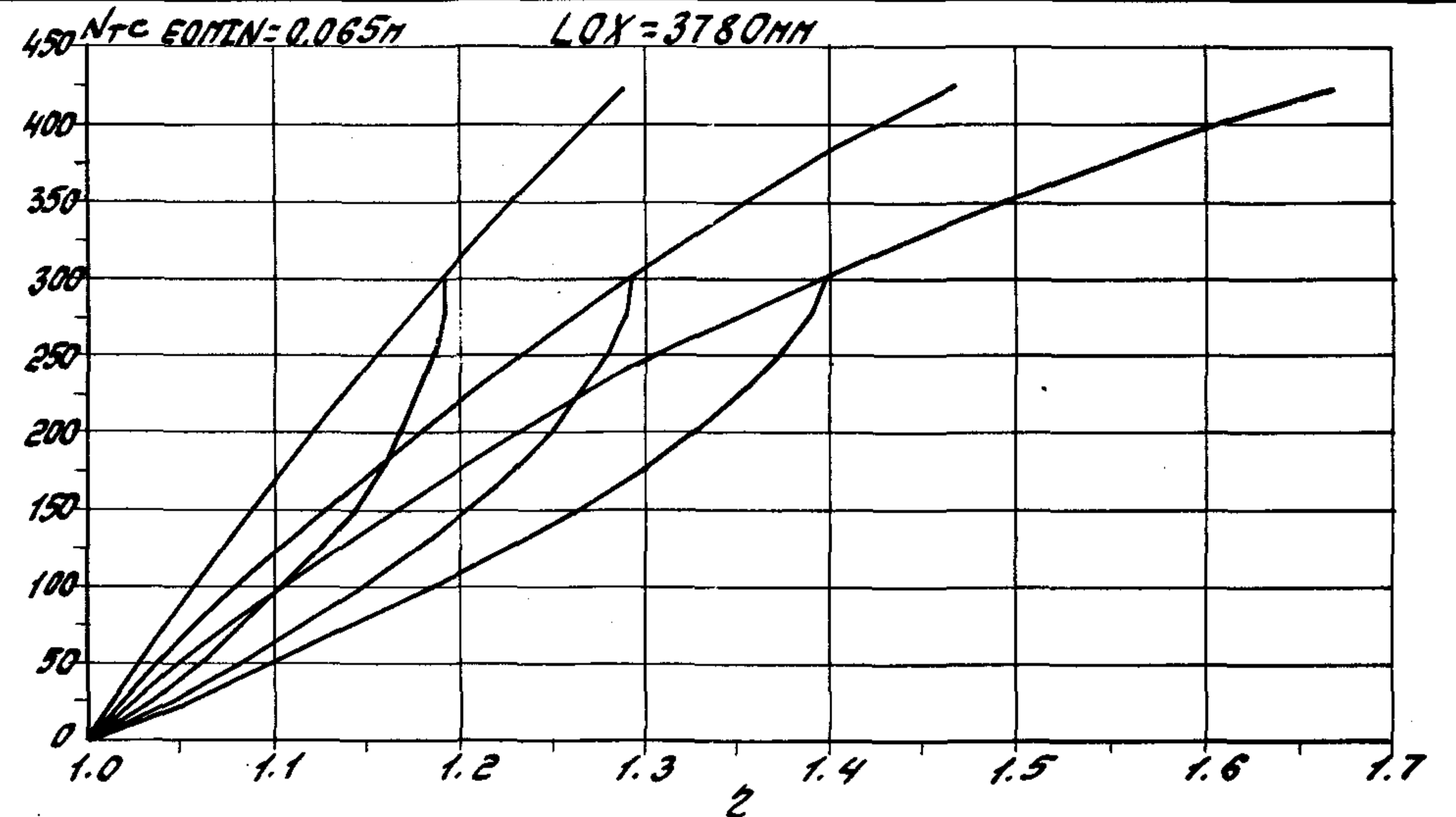
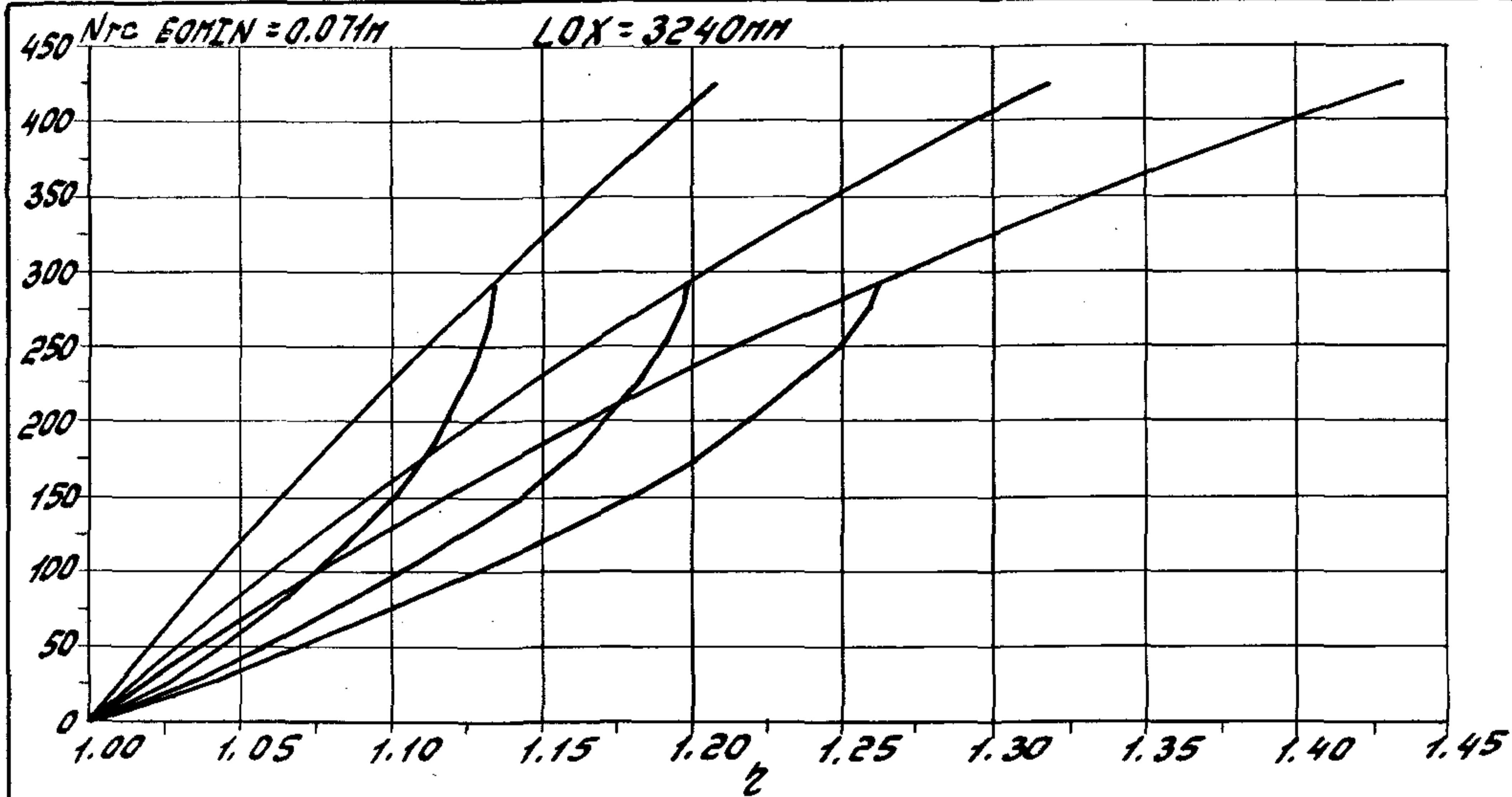

1.020. 1-4. 0-9 002

Rev
66

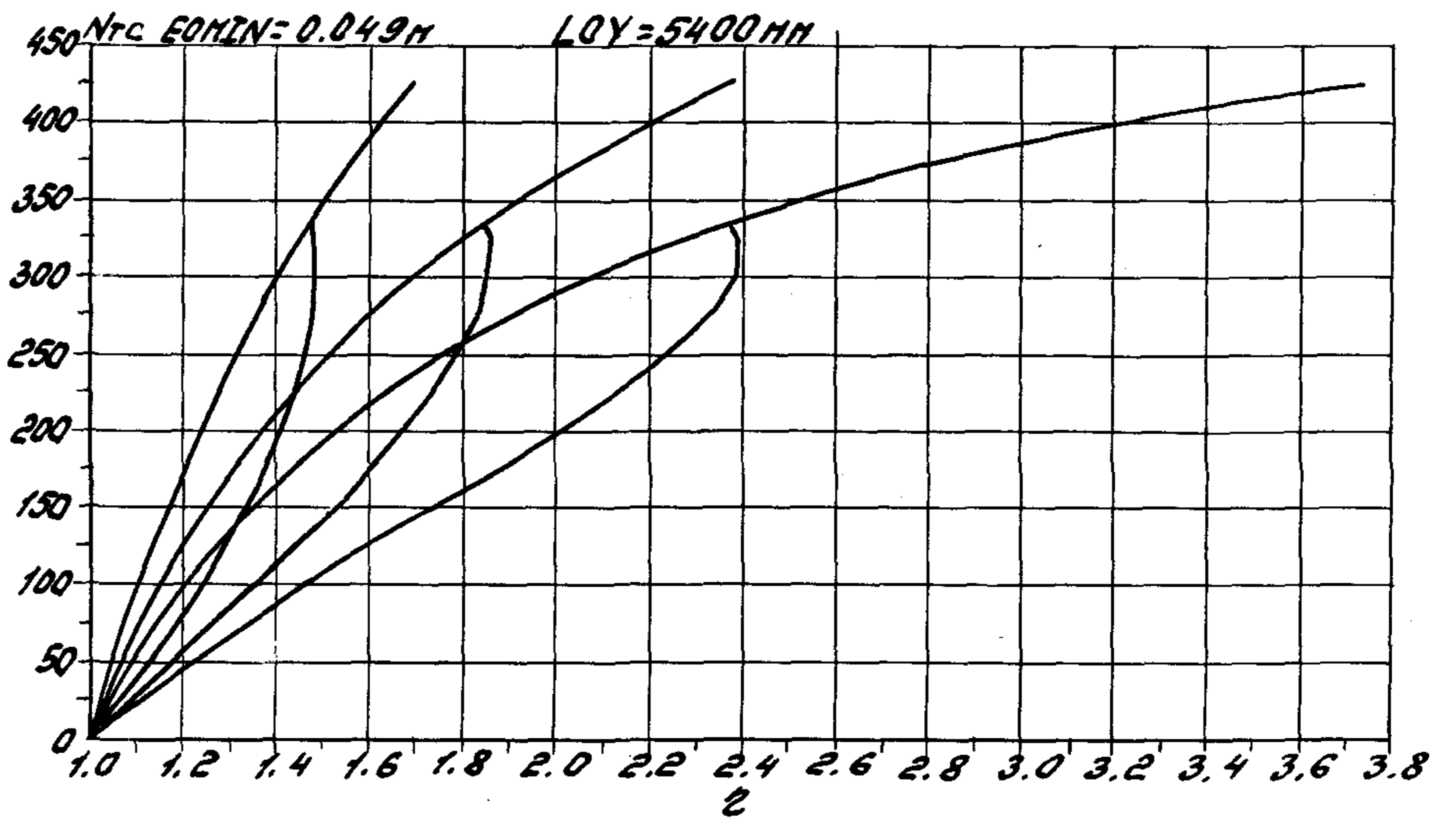
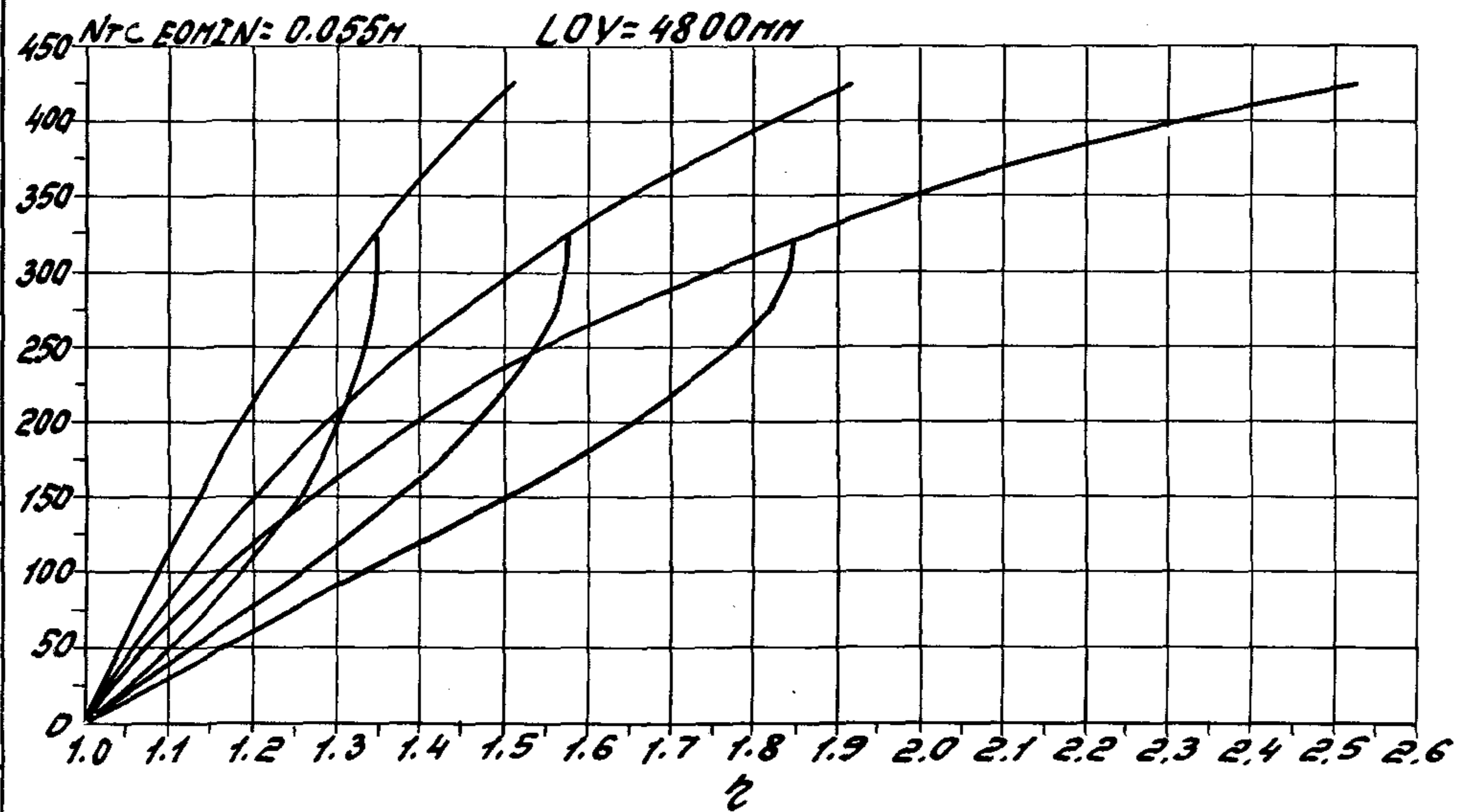
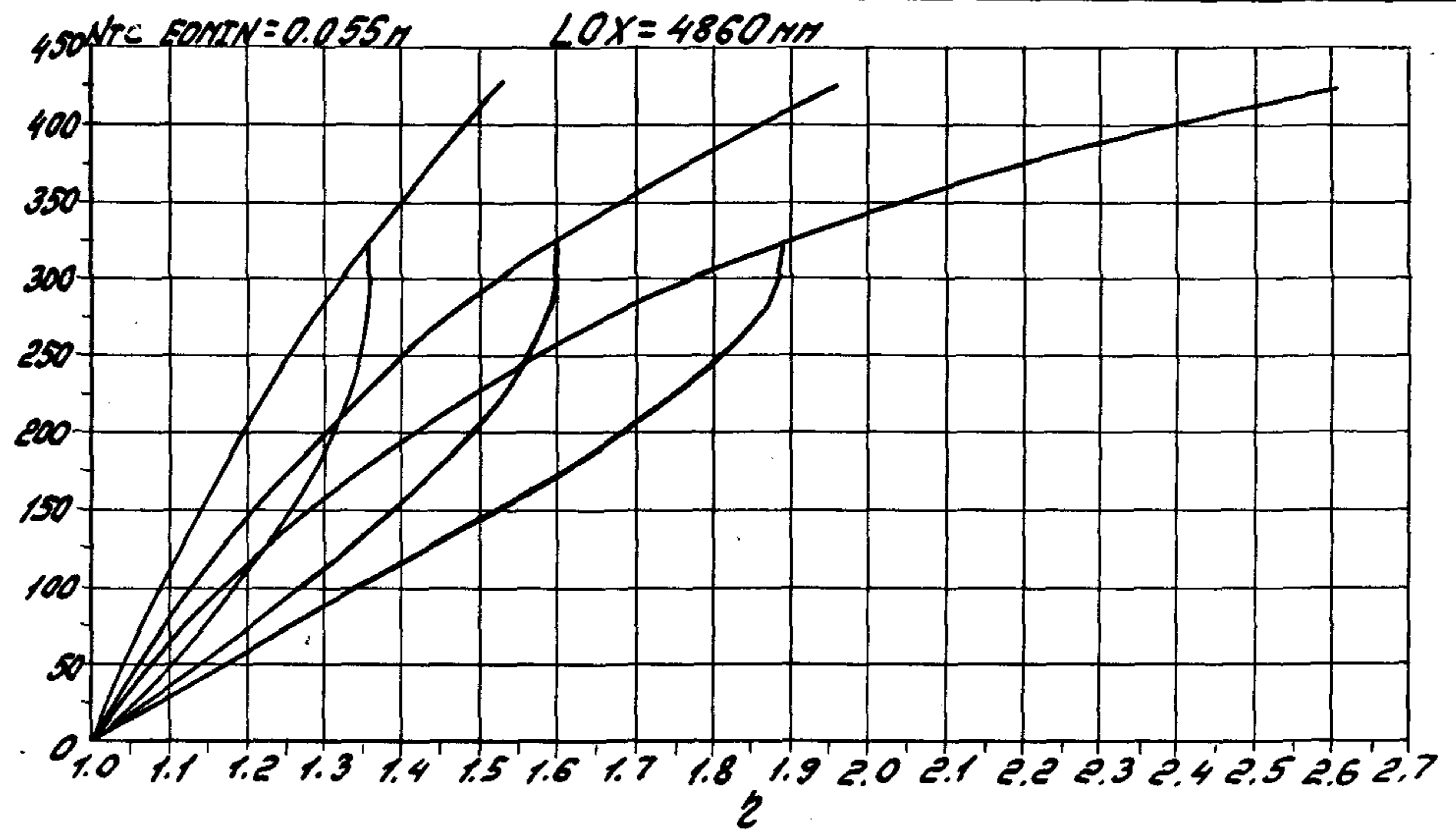
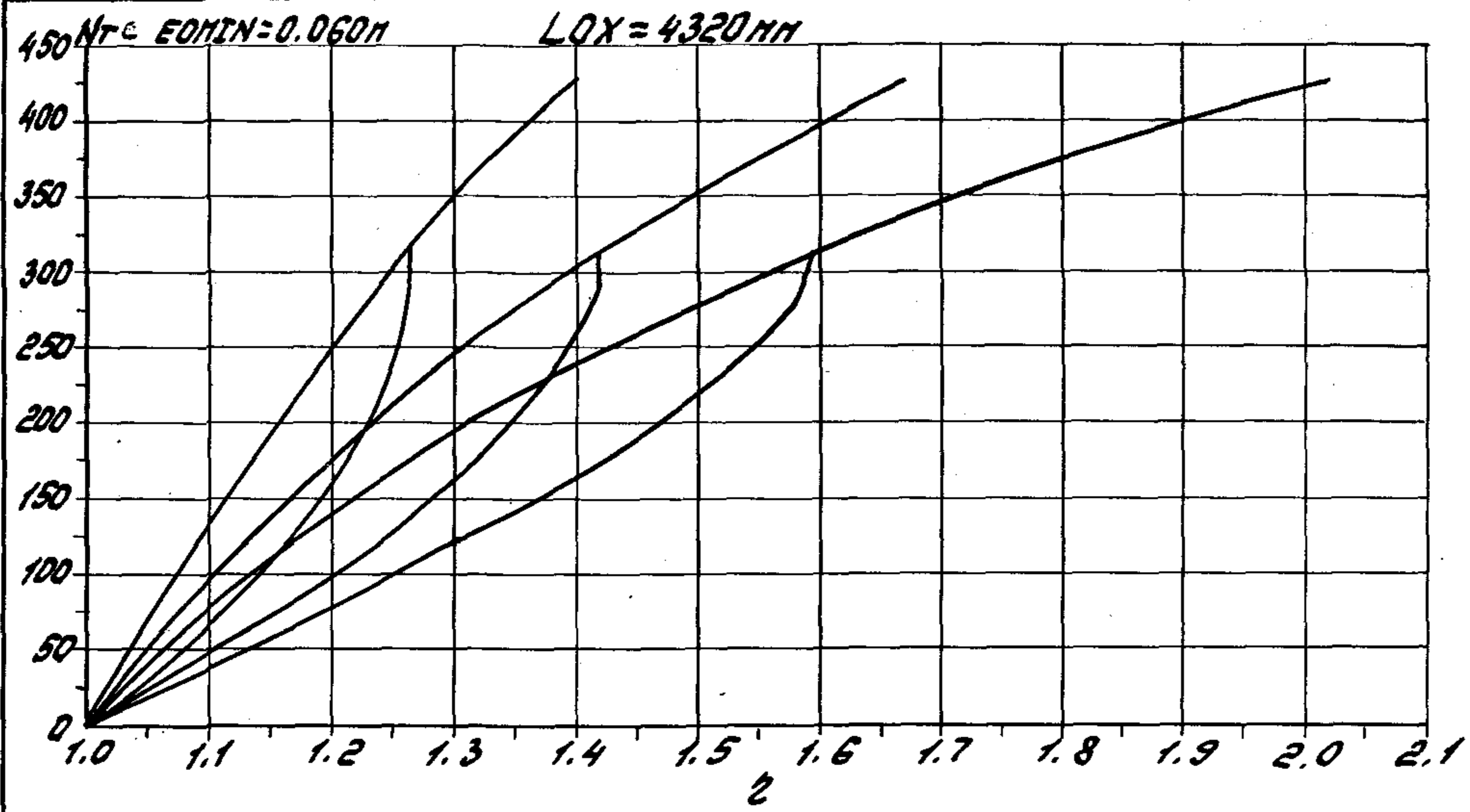

1.020. 1-4 0-9 002

Lucm

67

УИИБ. N. 17000. ВИСТУПЪ У ДОПНО ВЪЗМ. УИИБ. N.

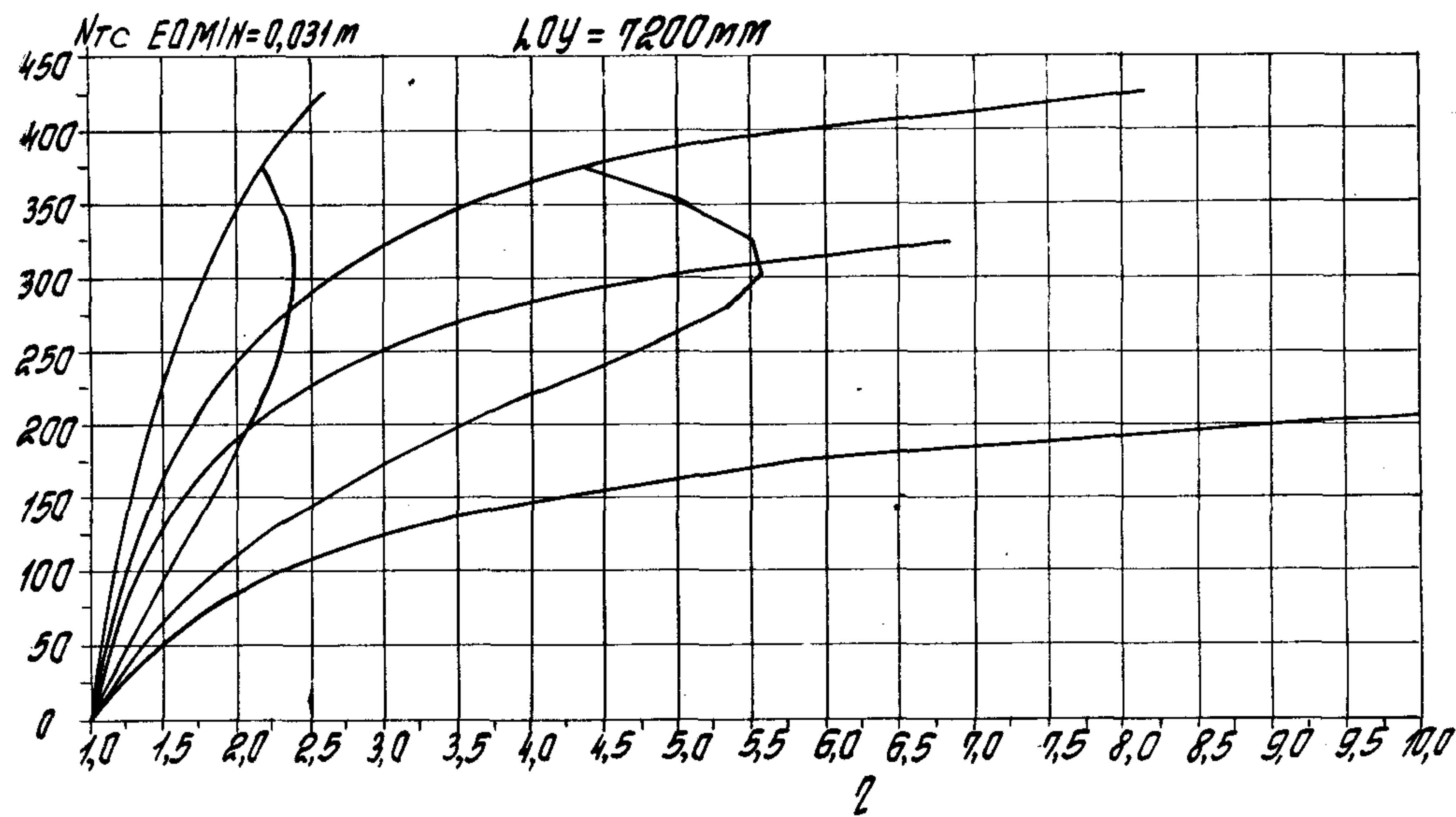
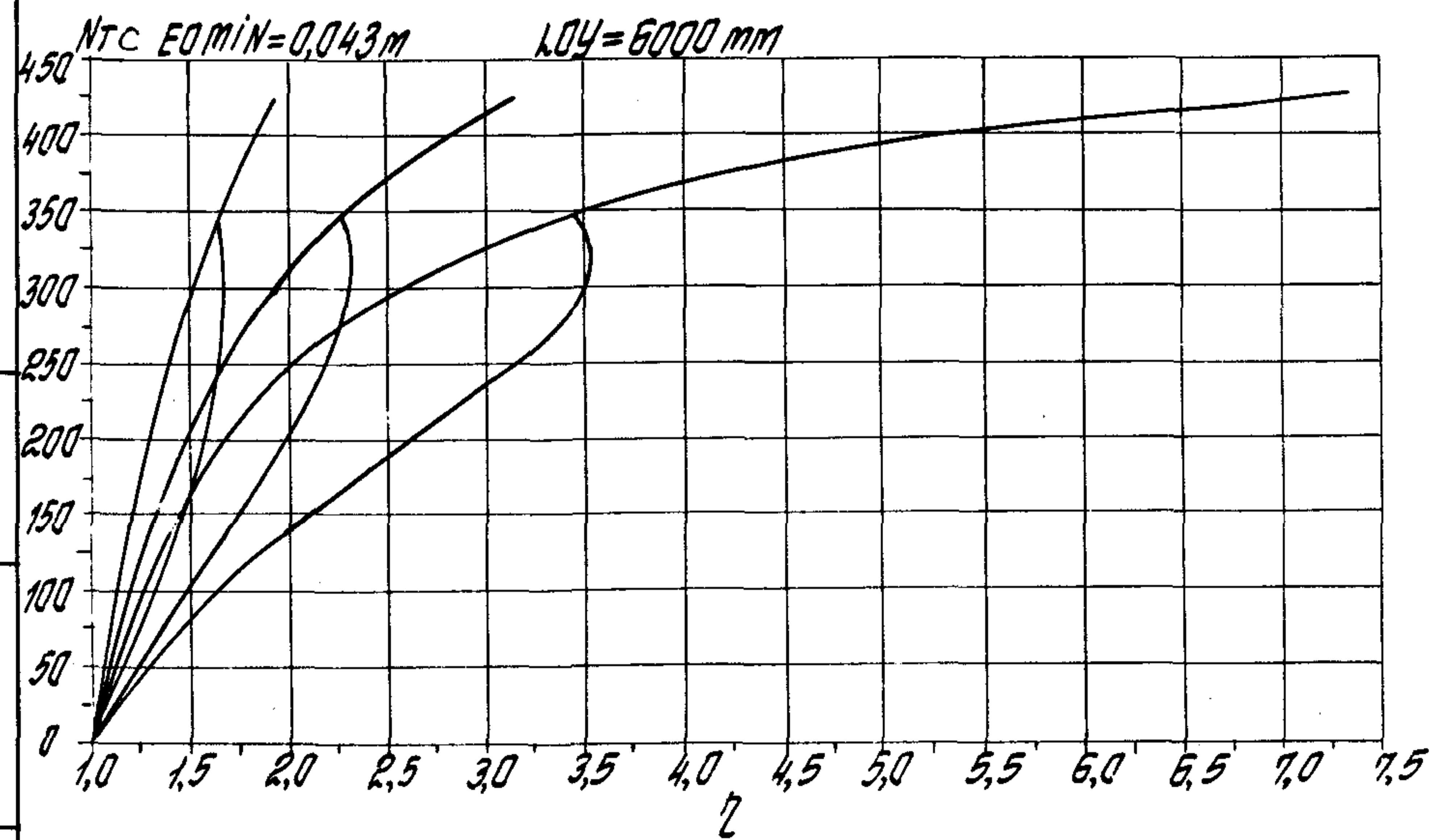
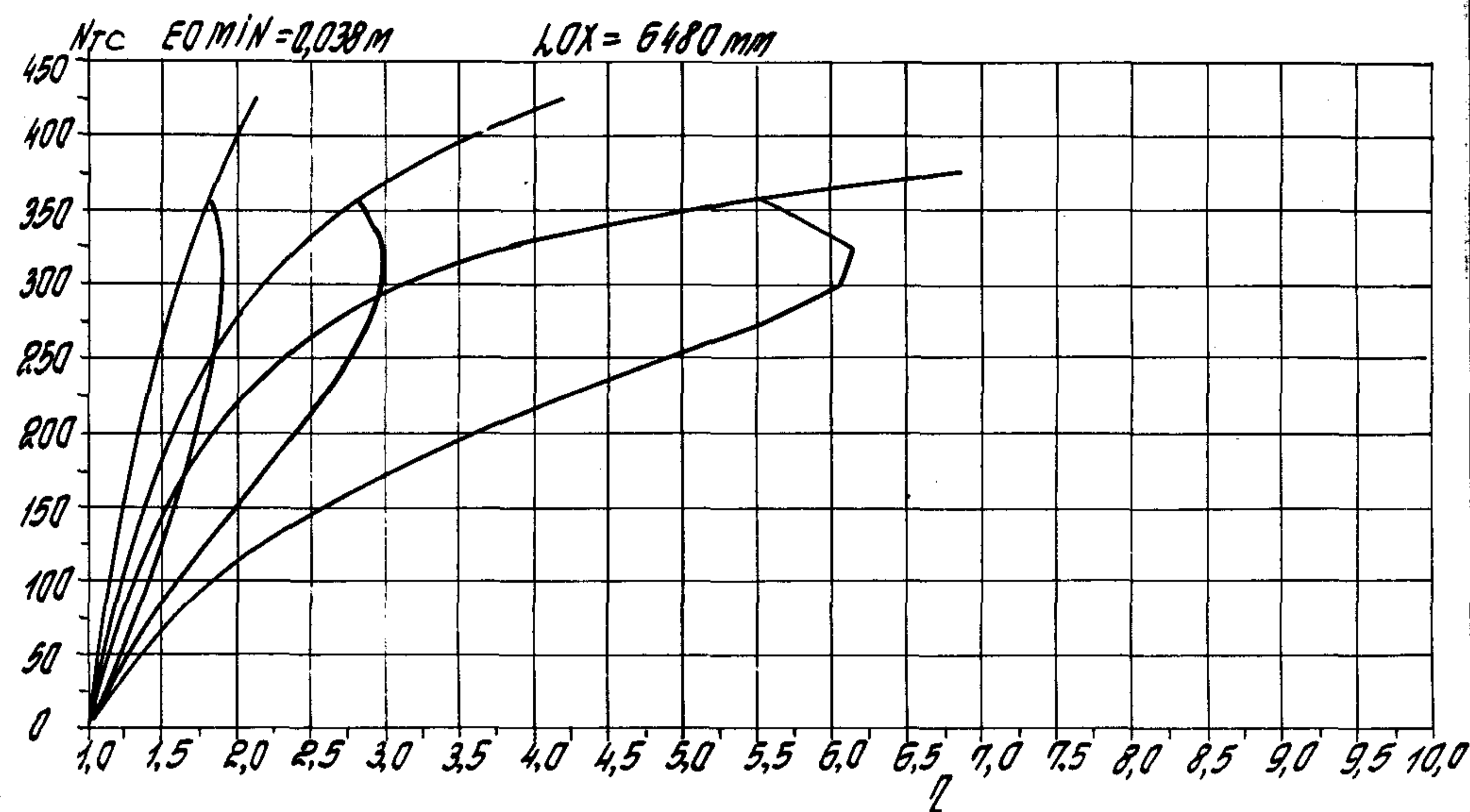
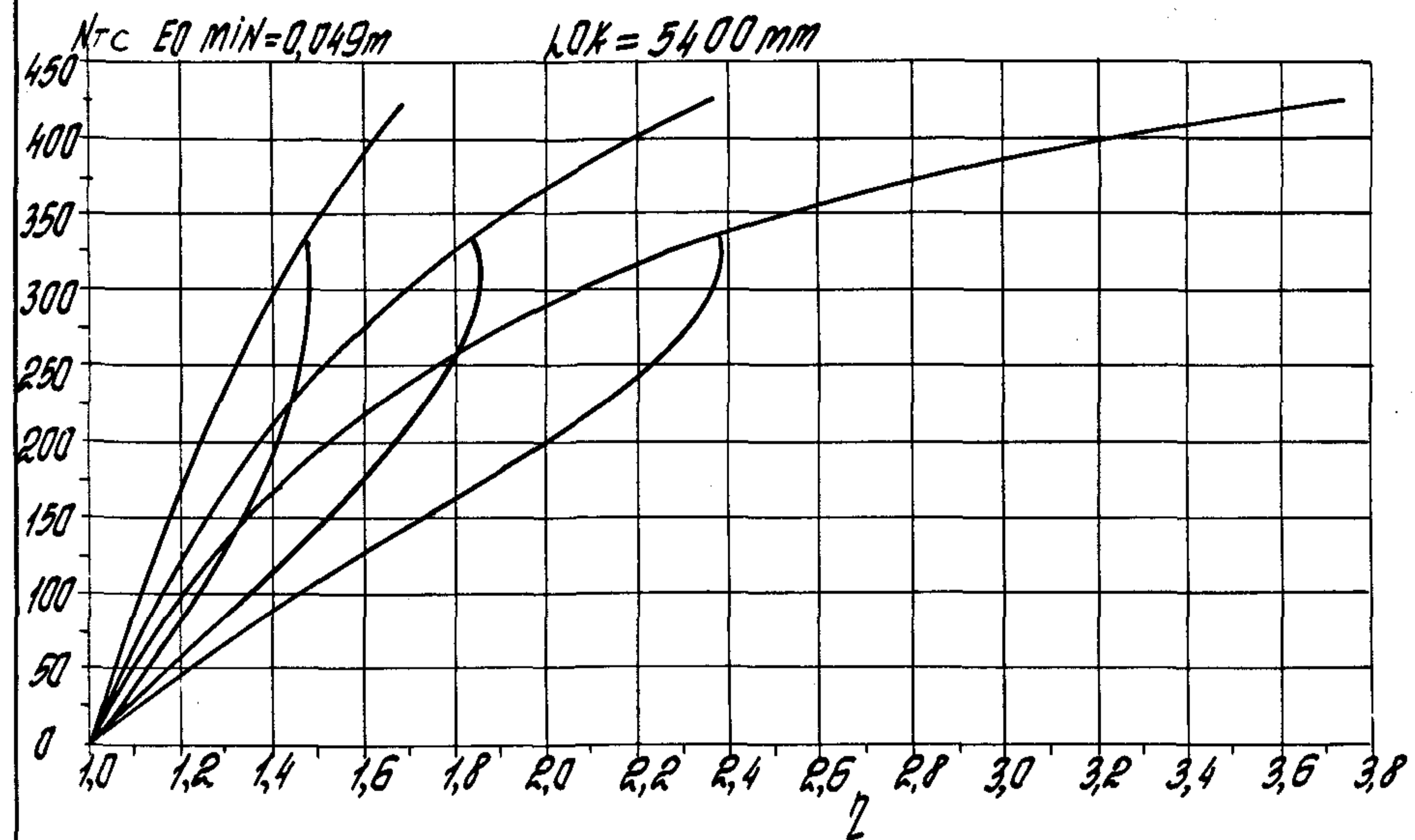

1.0201-4 0-9 002

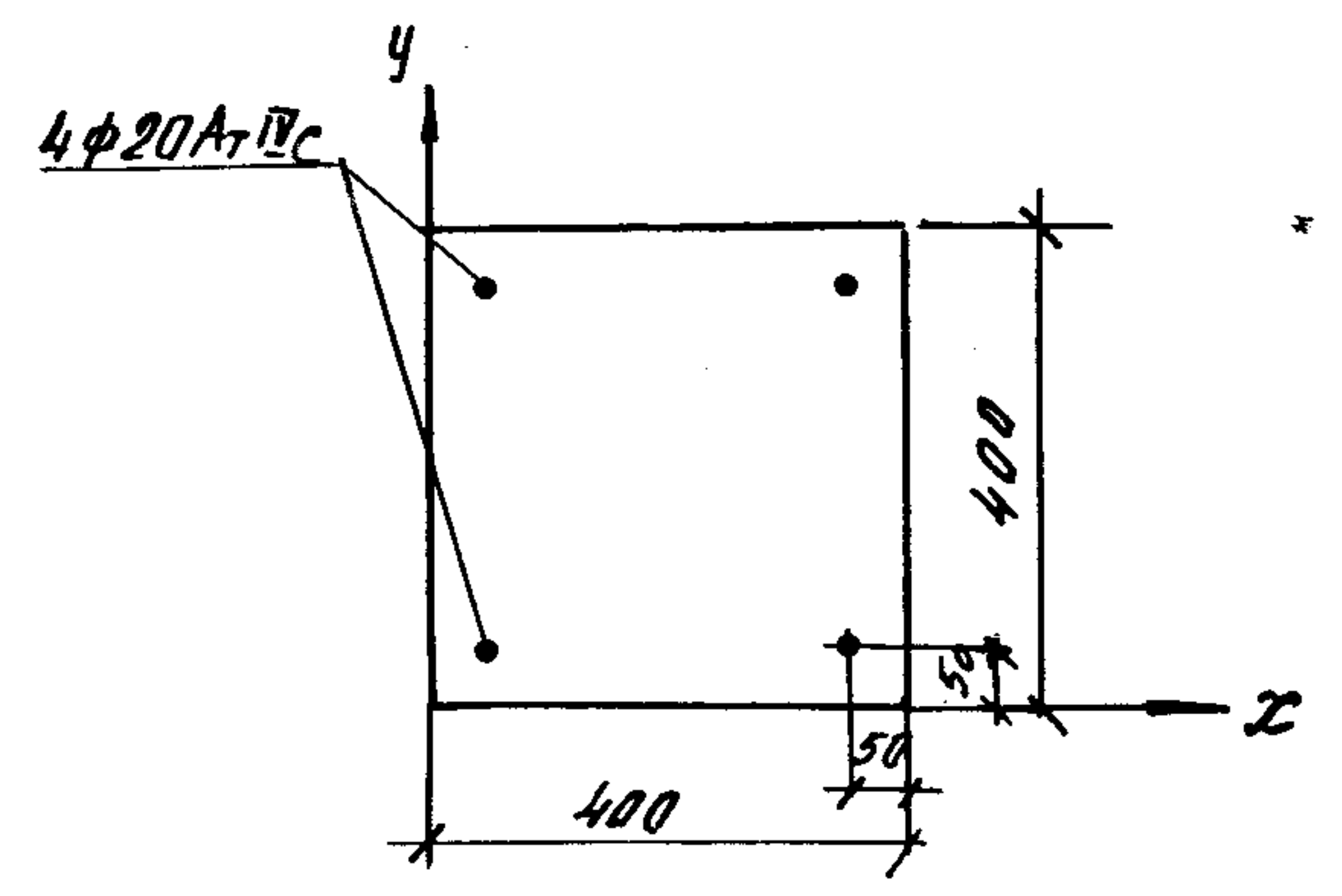
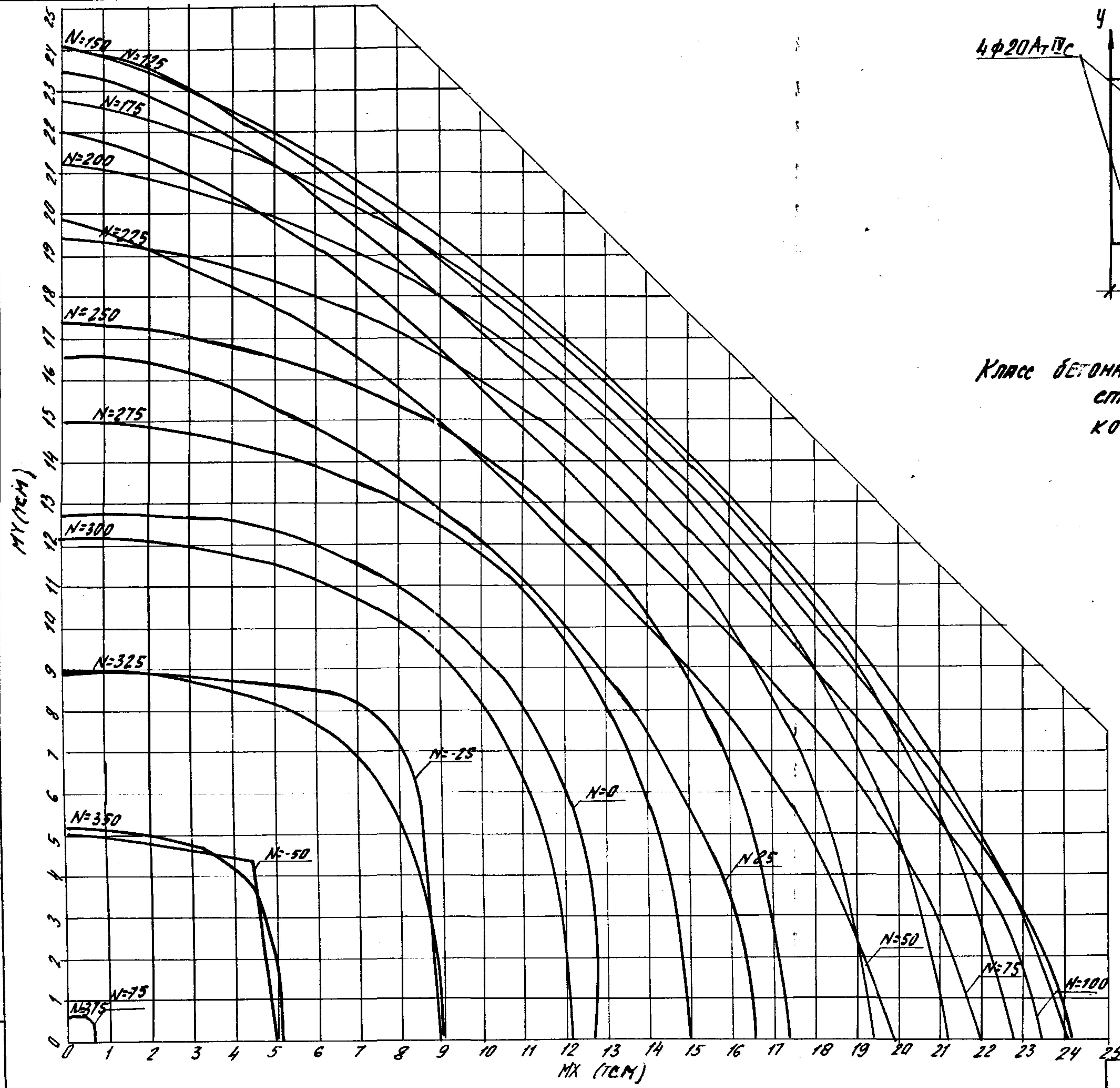

Класс бетона В40.0 ($R_b = 19,8$ МПа при учете $\gamma_{b2} = 0,90$)
 сталь А7-III
 код сечения - 1095

Инв. № 10001. Подпись и дата 2019. 04. 04 № 2

1.020.1-4 0-9 002

лист
69

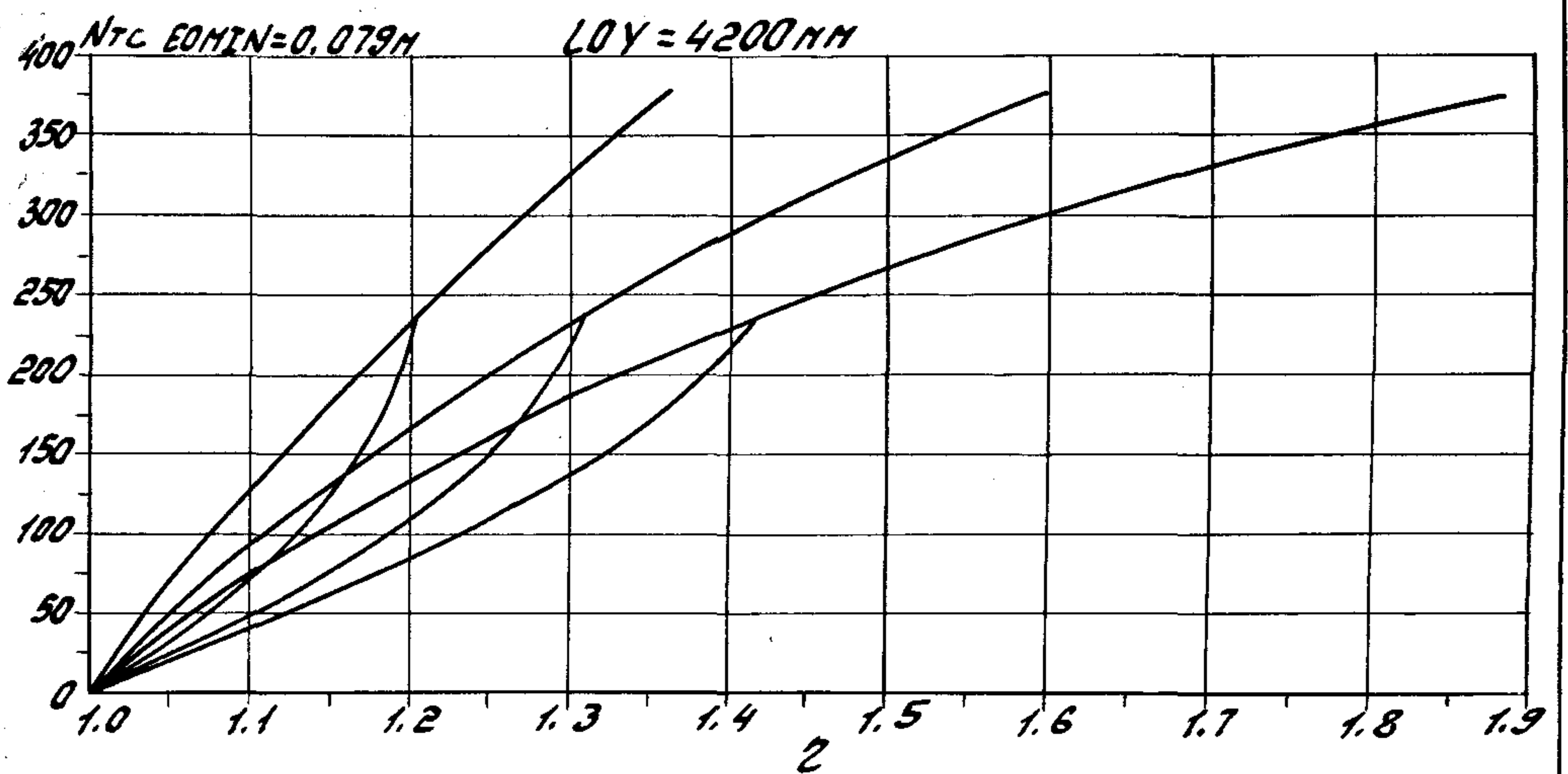
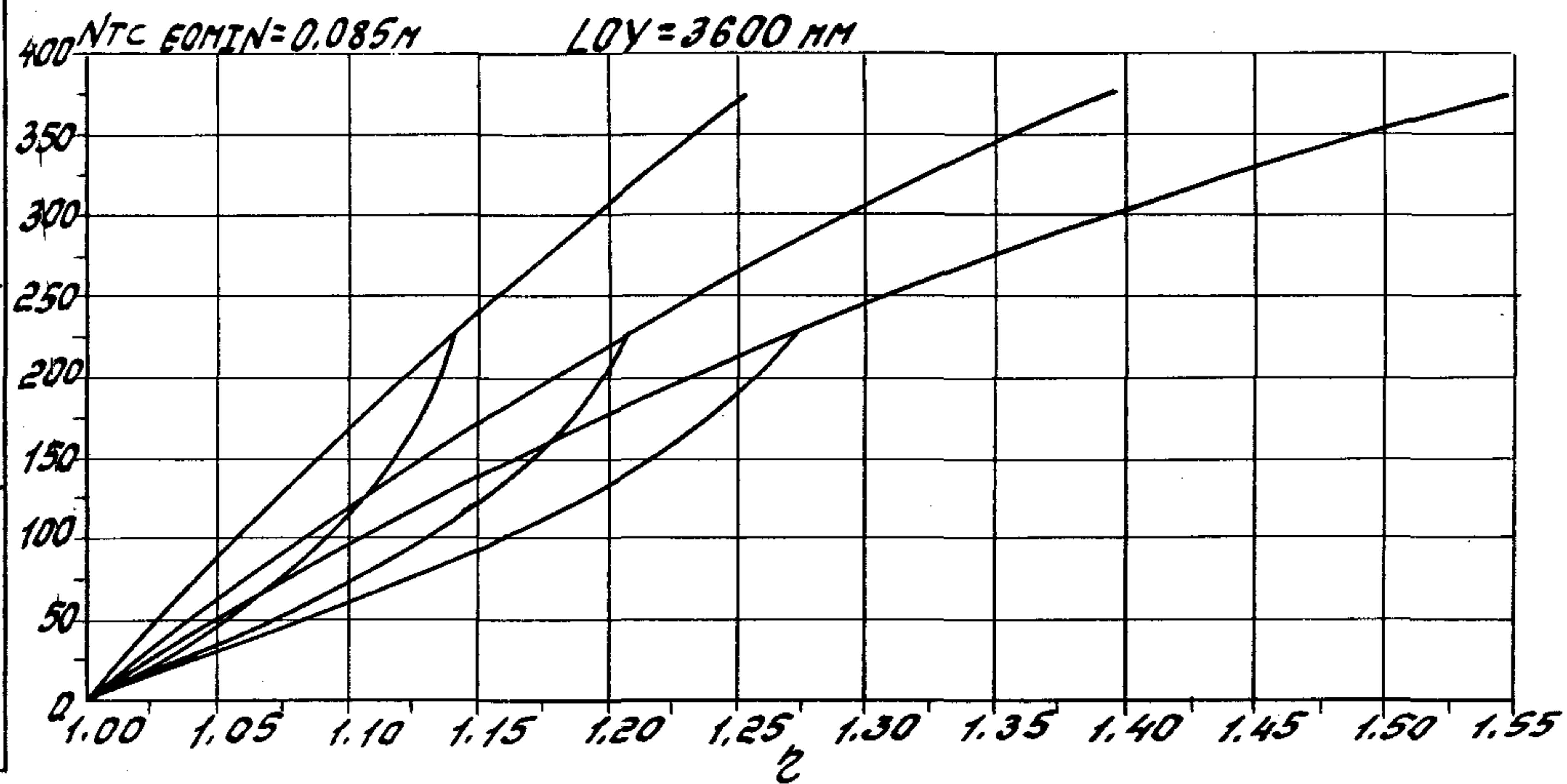
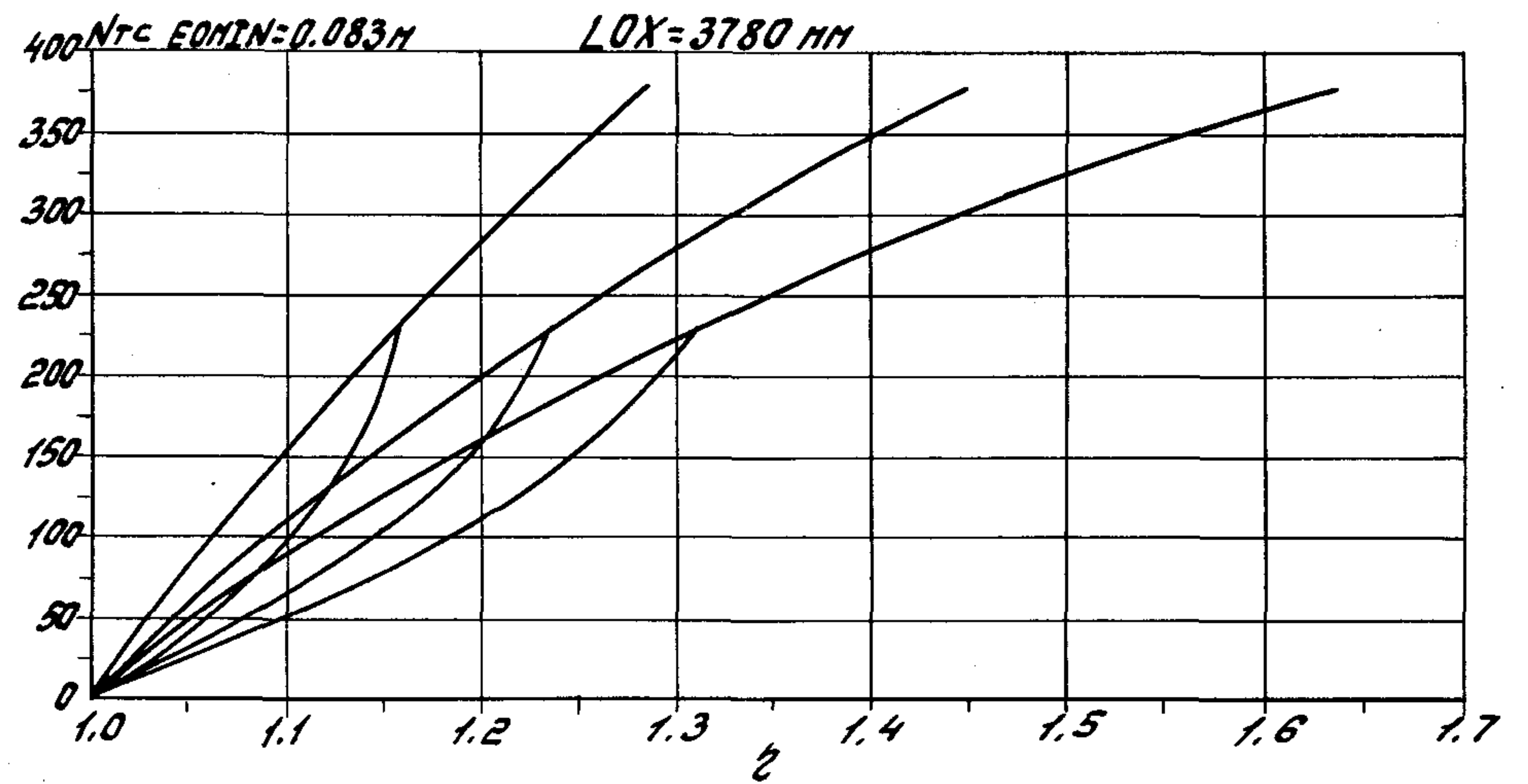
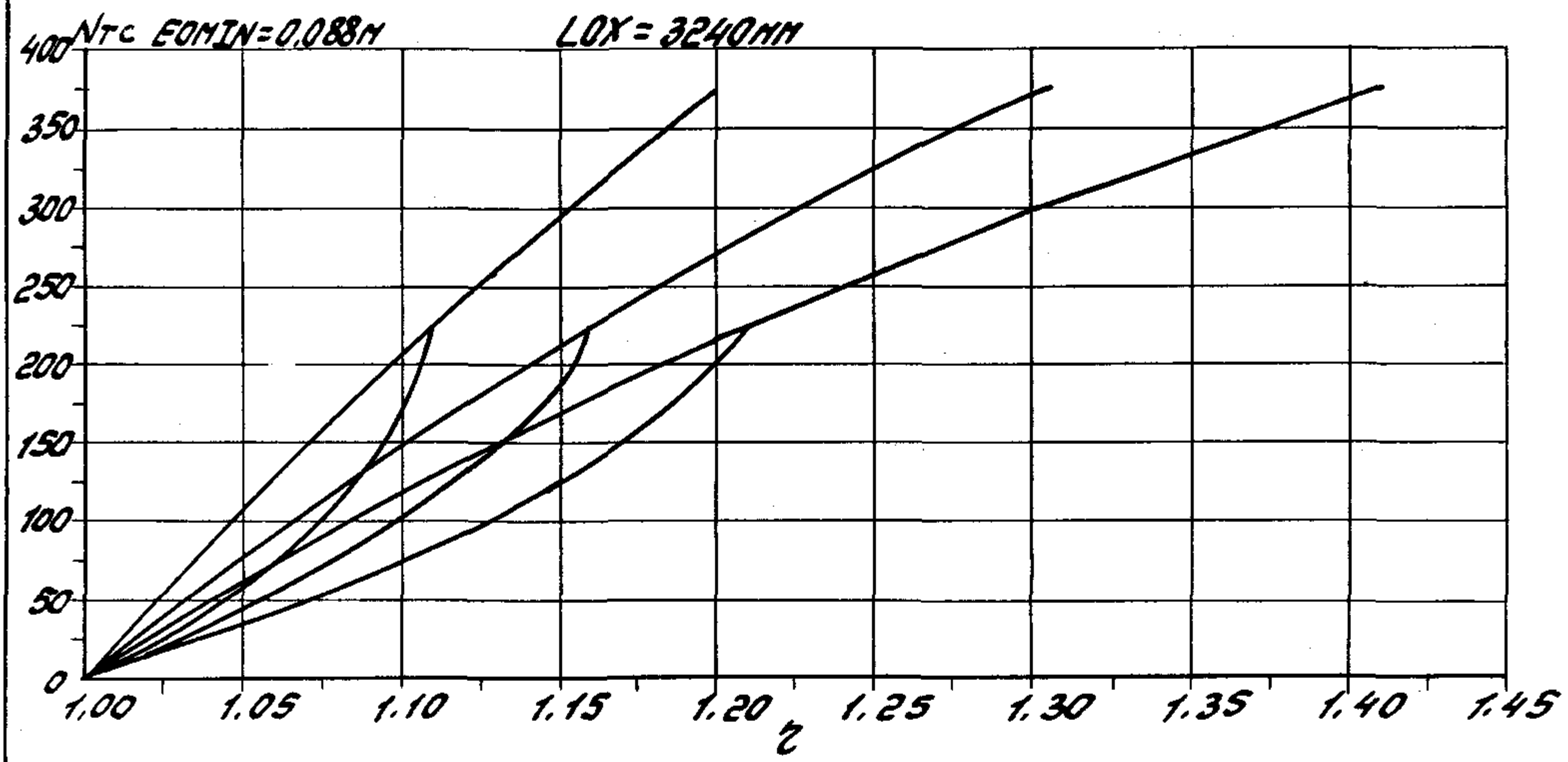

1.020. 1-4 0-9 002 Docm
70

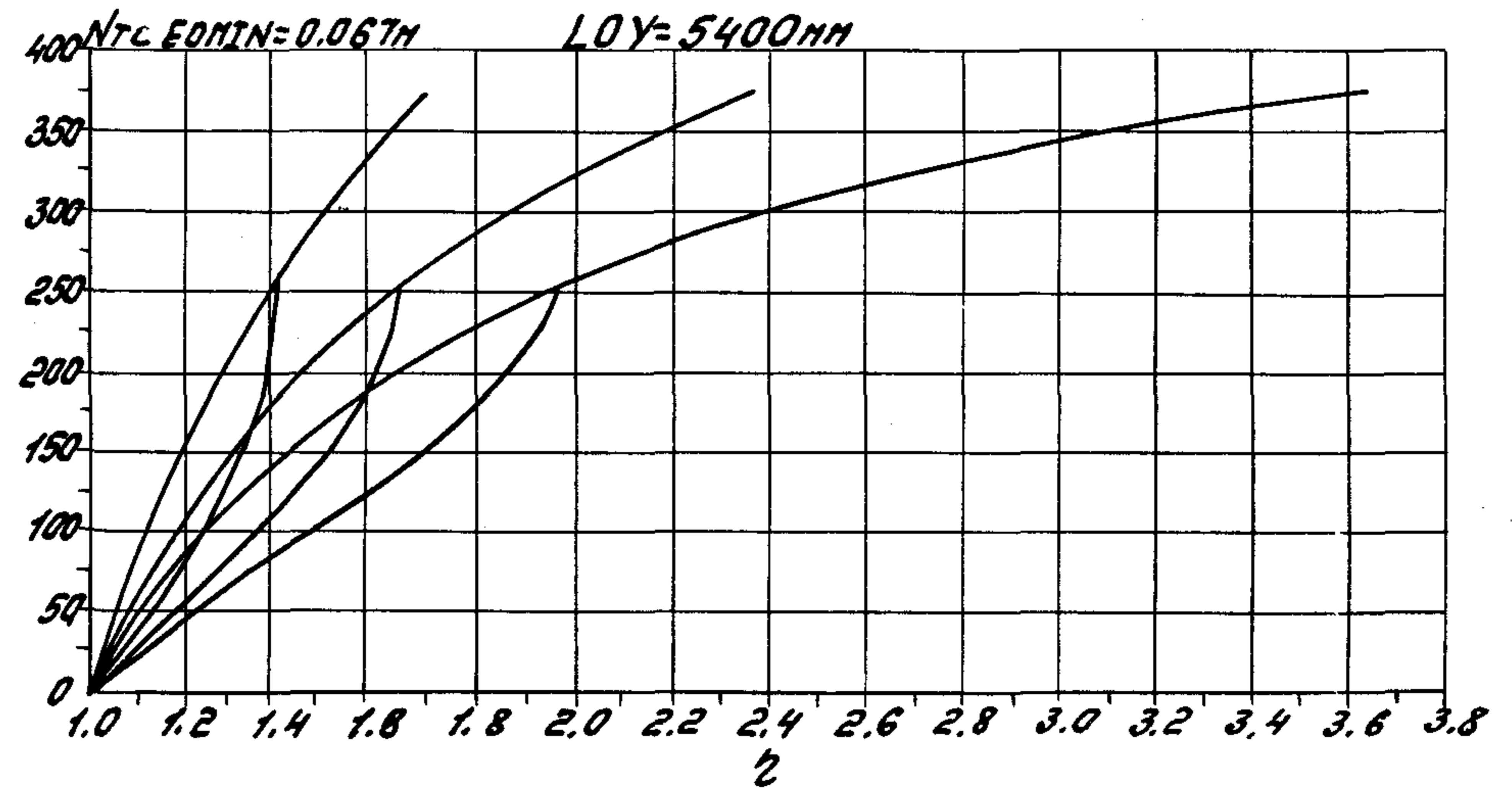
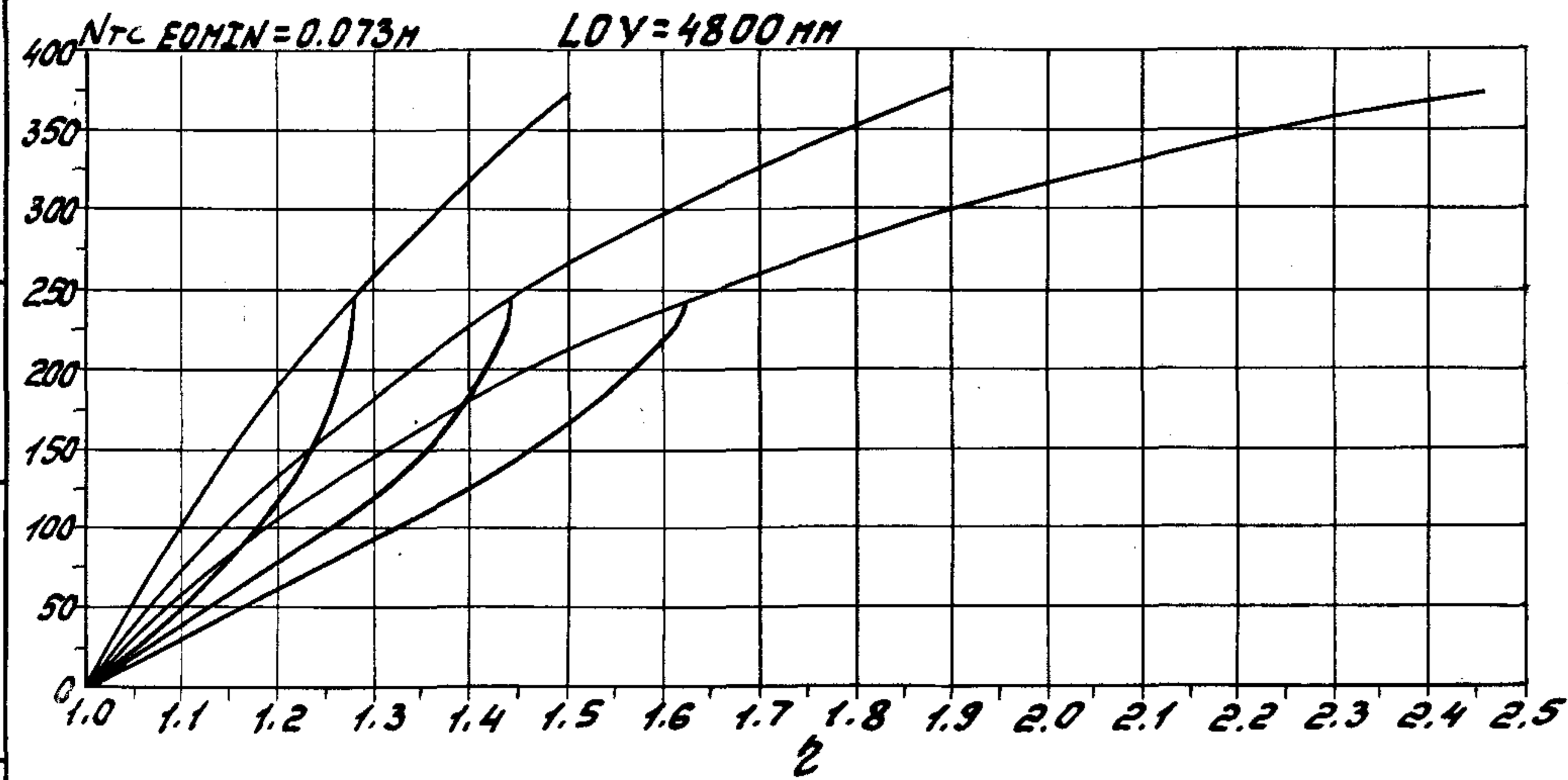
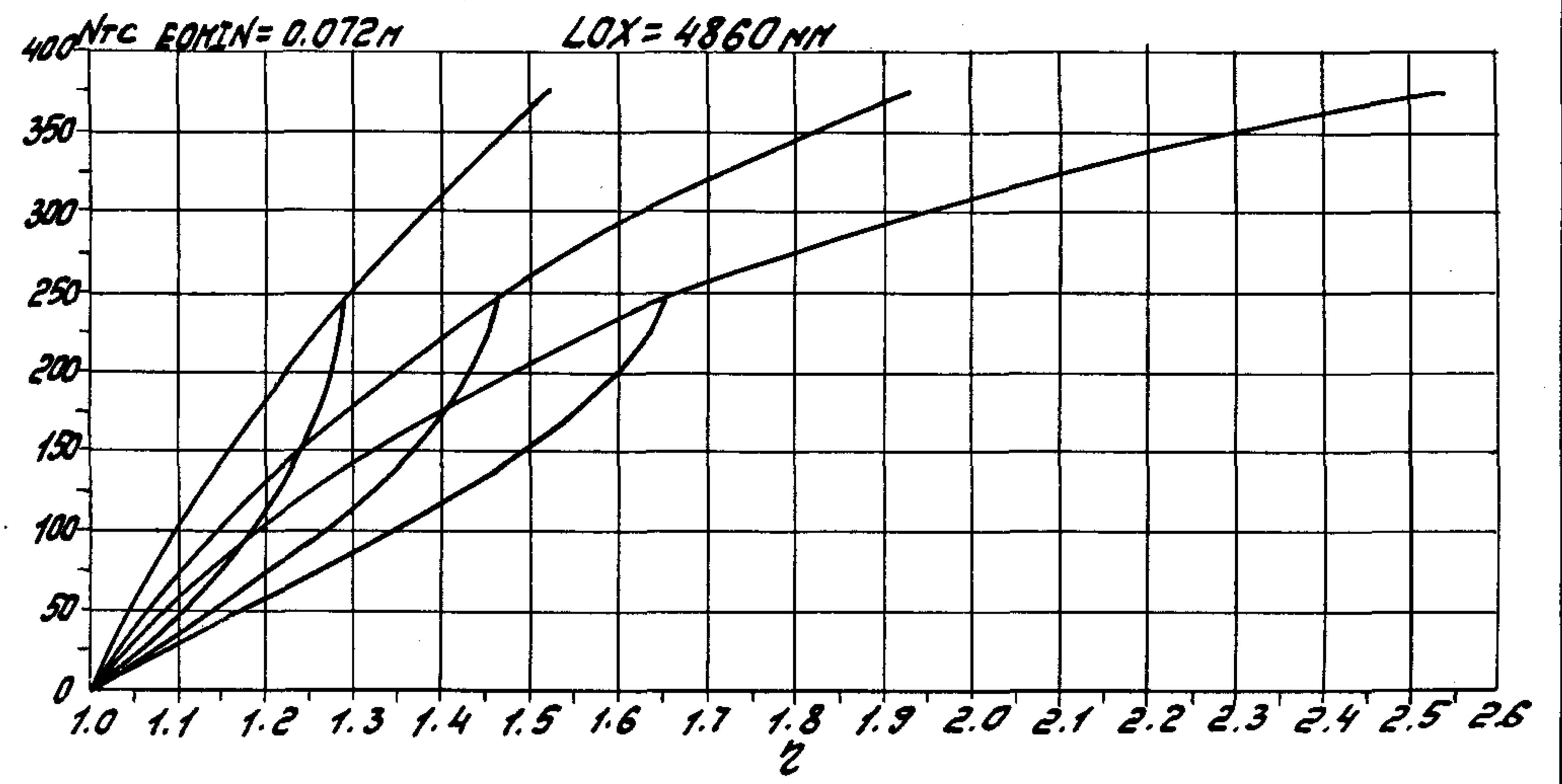
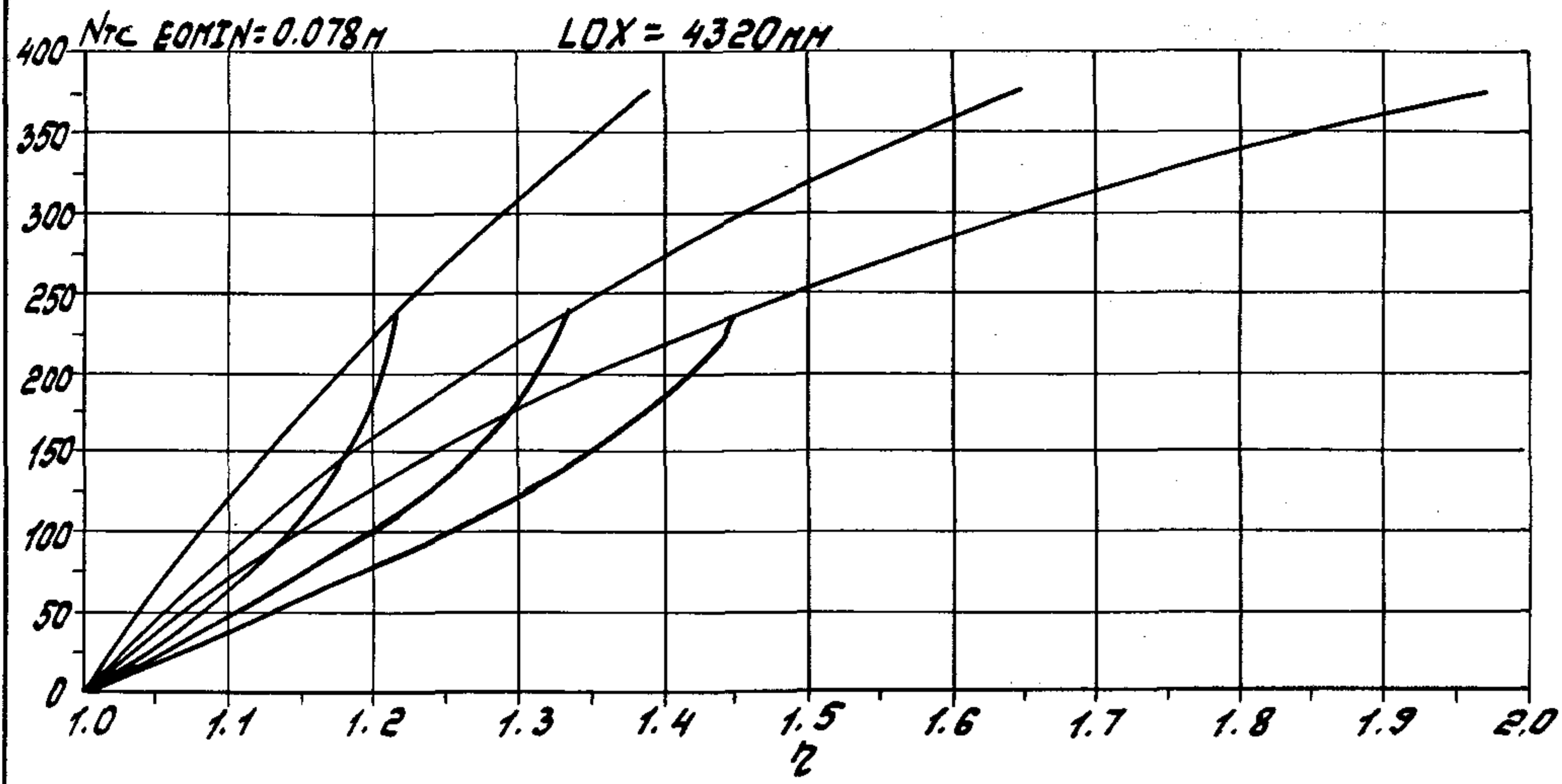

1.020.1-4 0-9 002

JUCH
71

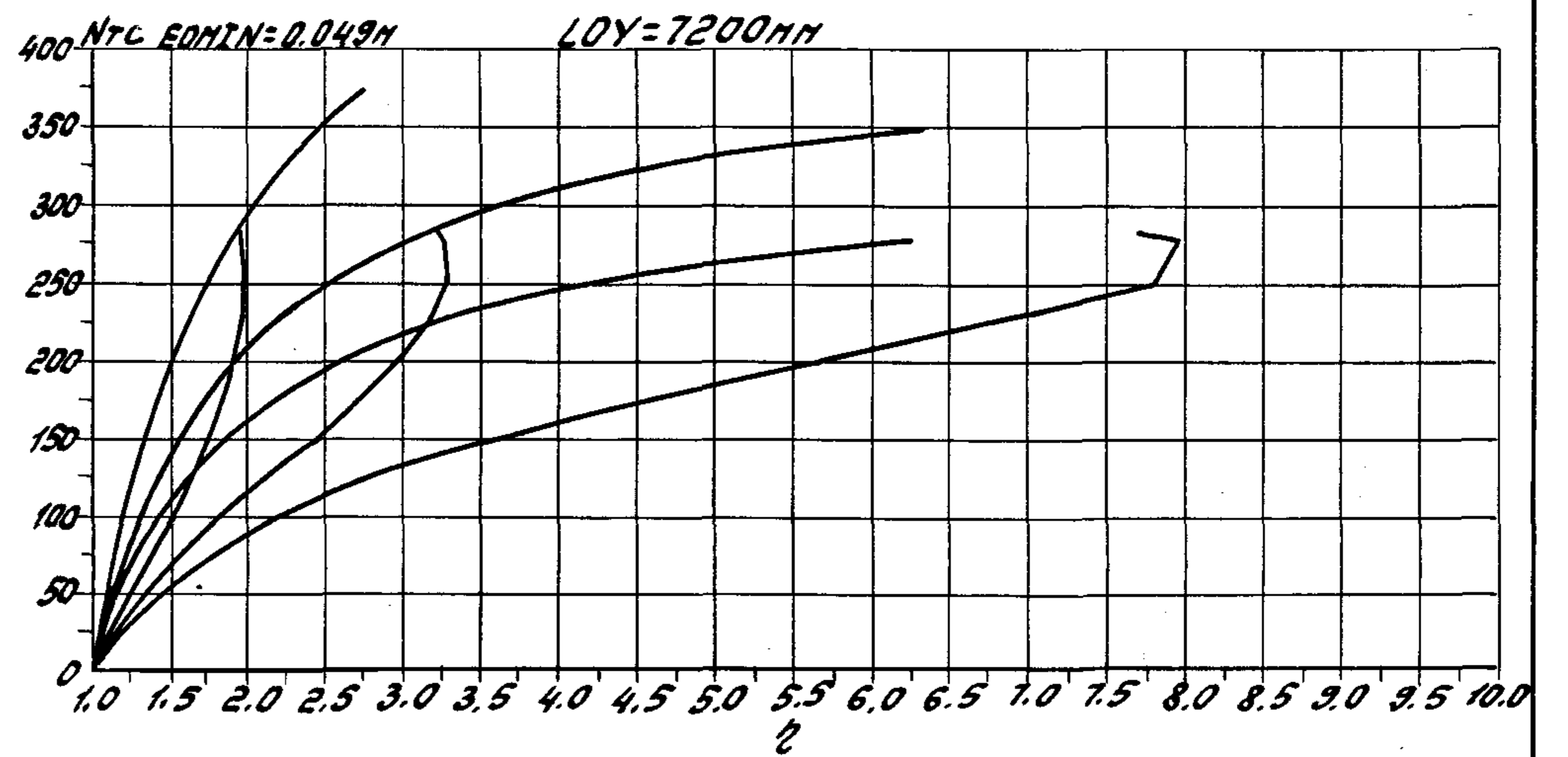
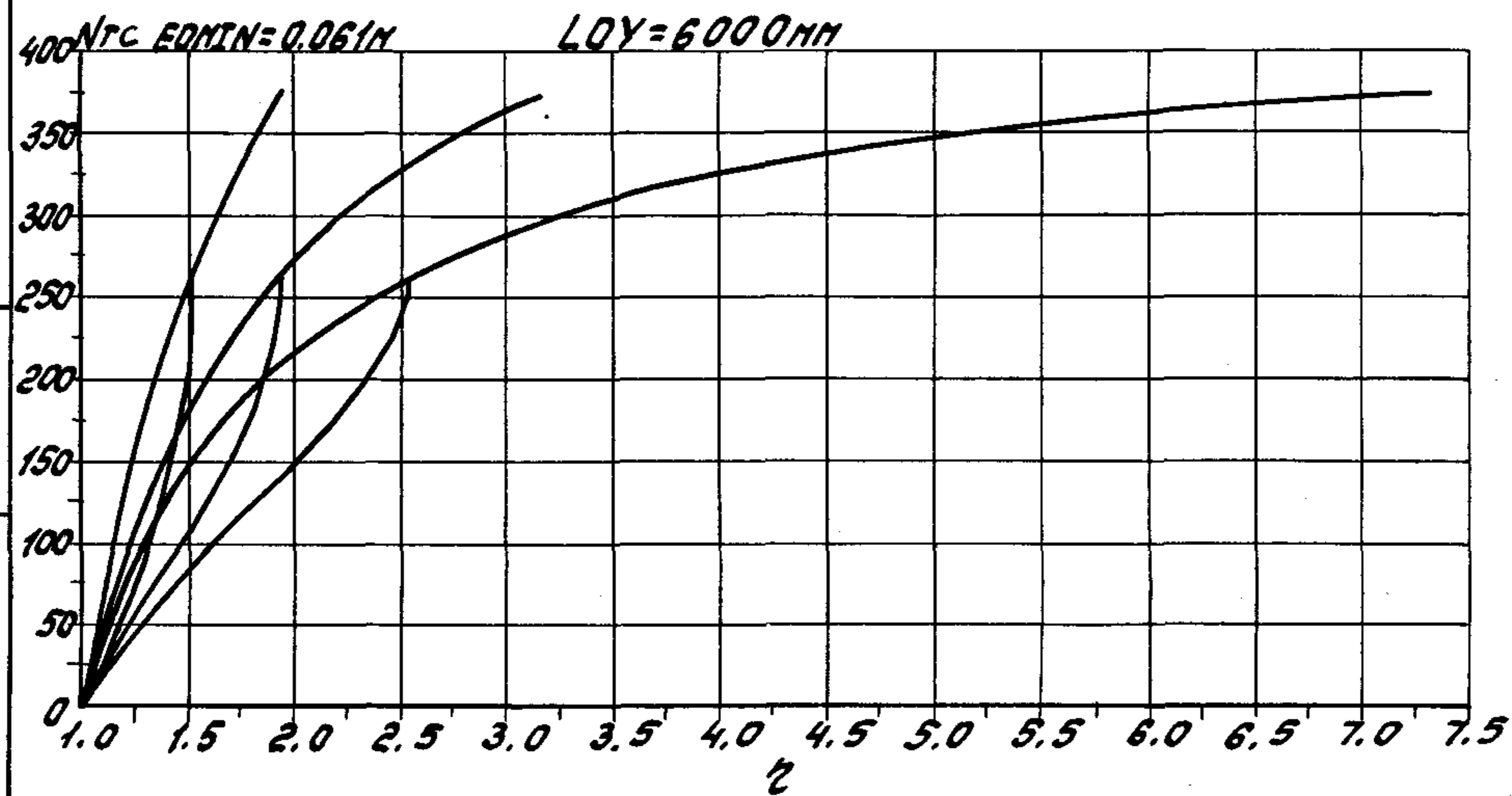
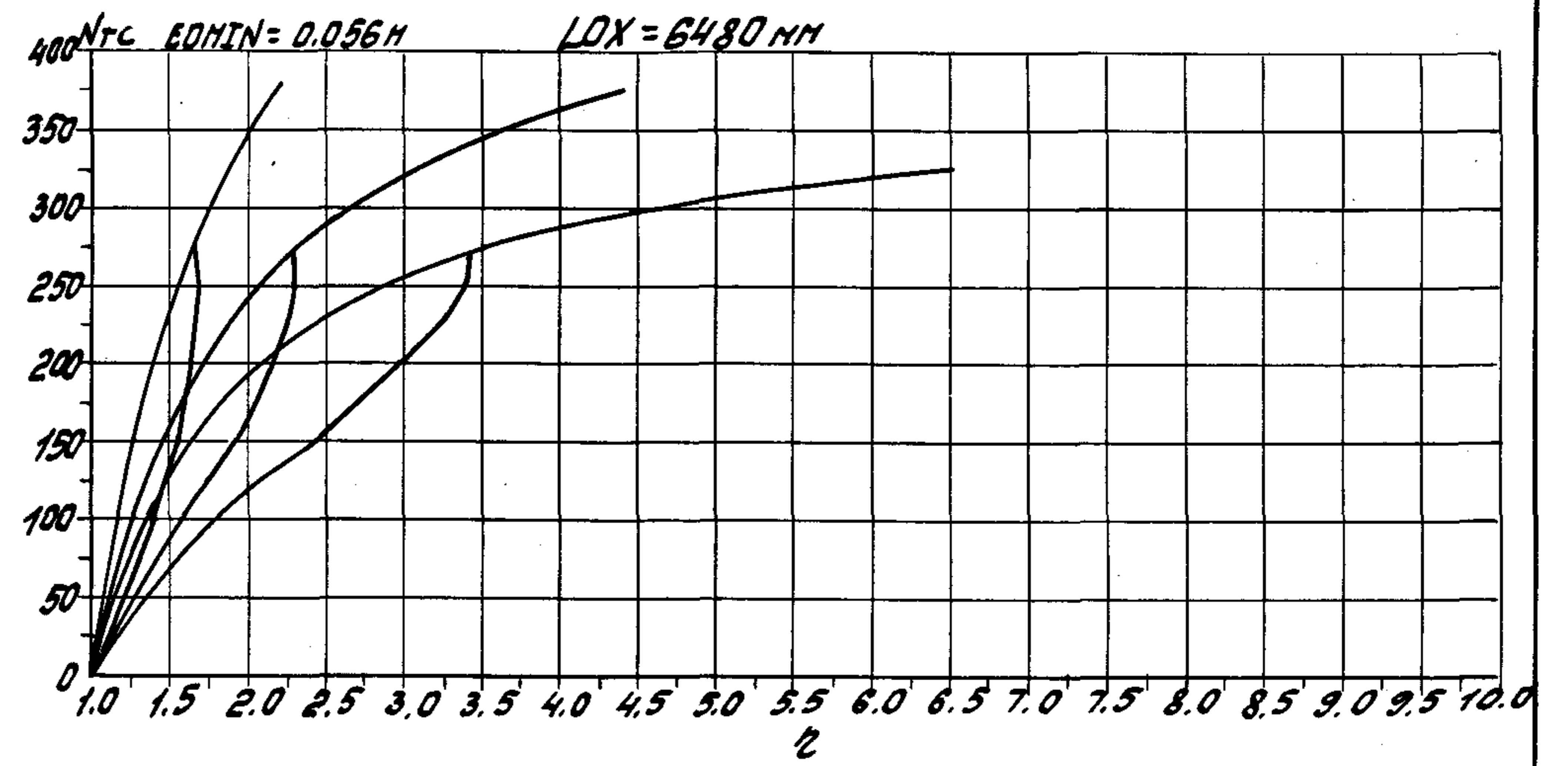
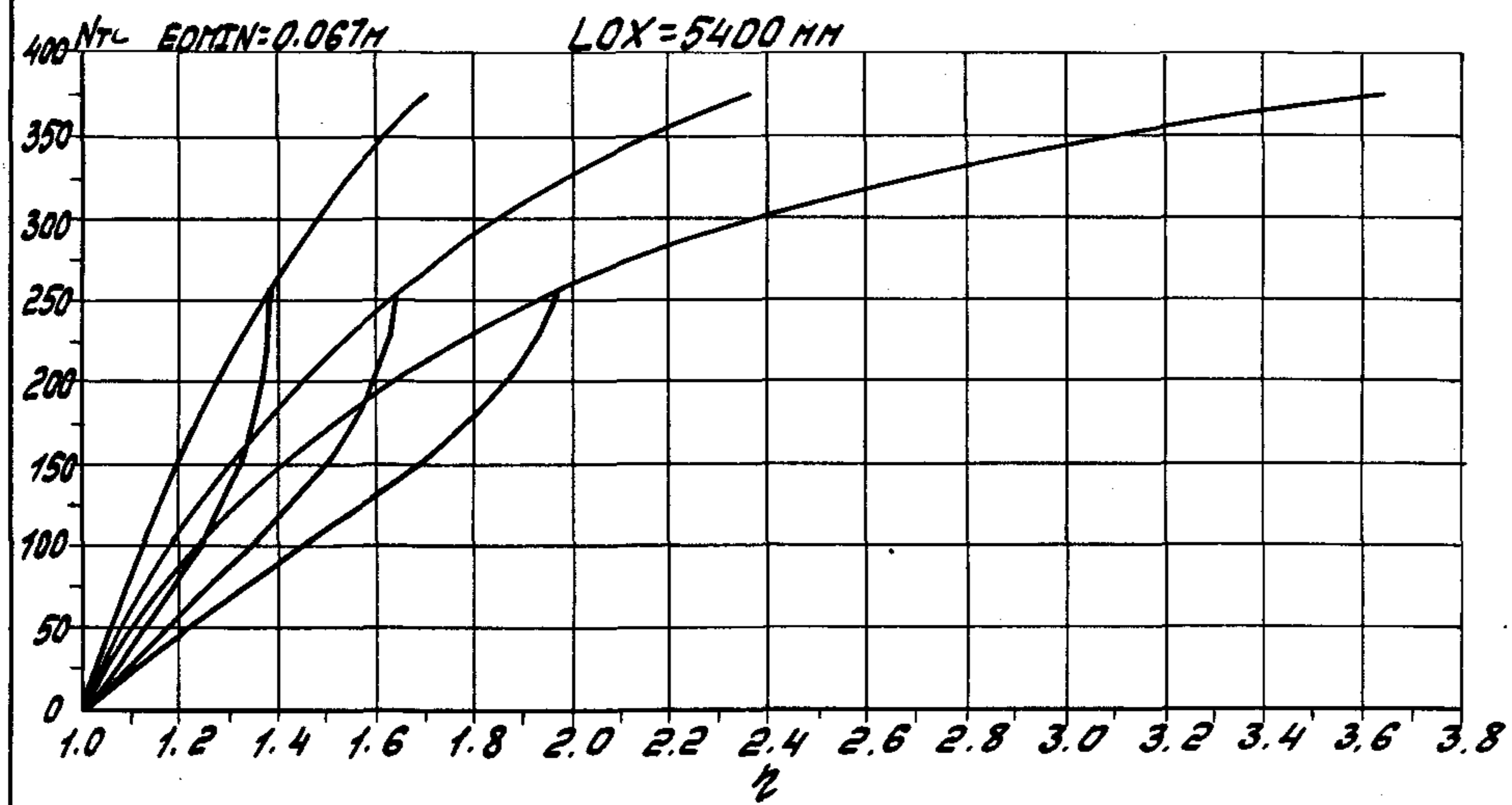

1.020.1-4 0-9 002 72

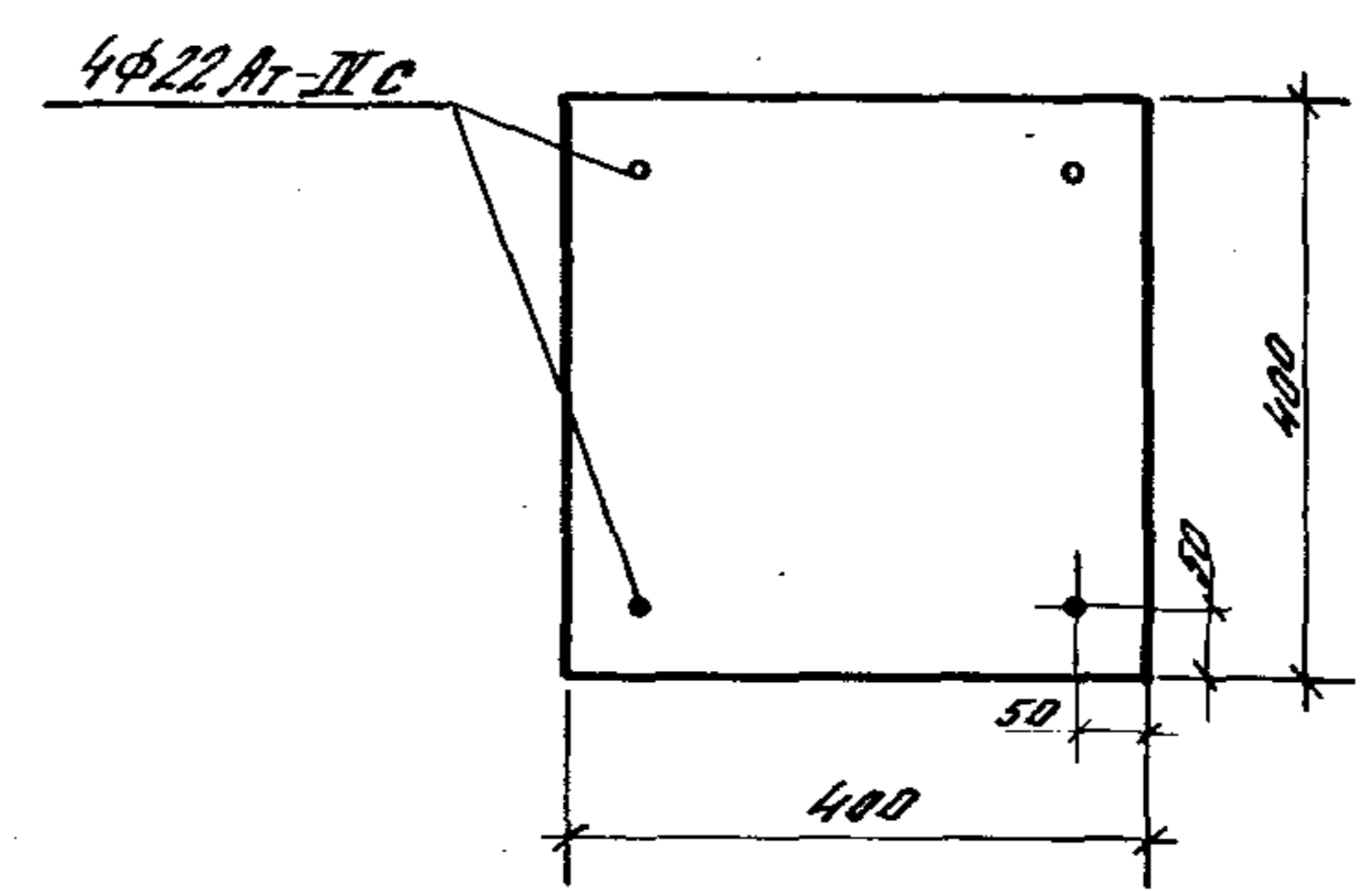
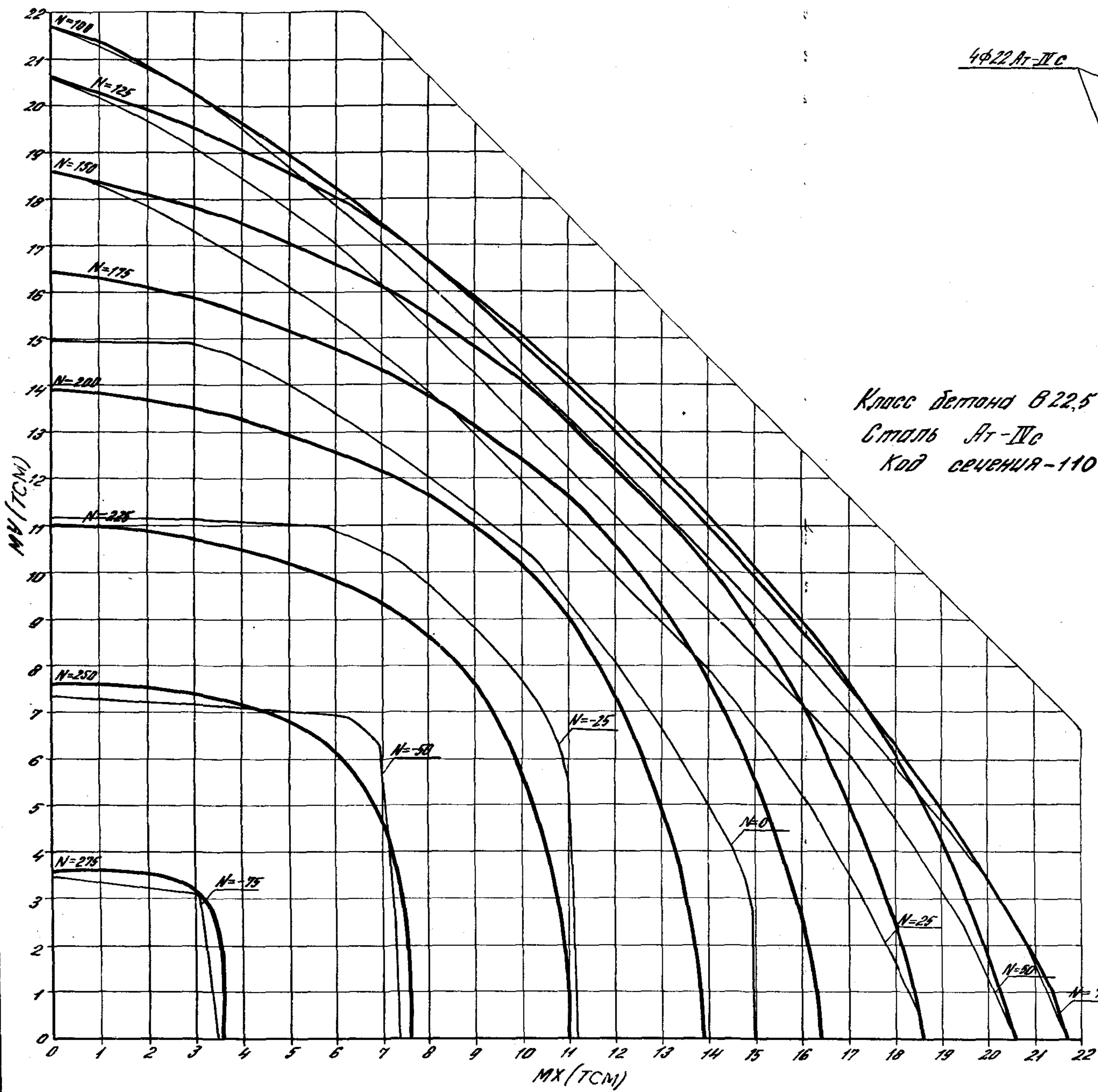

Класс бетона В22,5 ($R_b = 14,3 \text{ МПа}$ при учете $\gamma_{b2} = 1,10$)
 Сталь Ar-IVc
 Код сечения - 110а

Мод. и код. Серия и дата вып. инст.

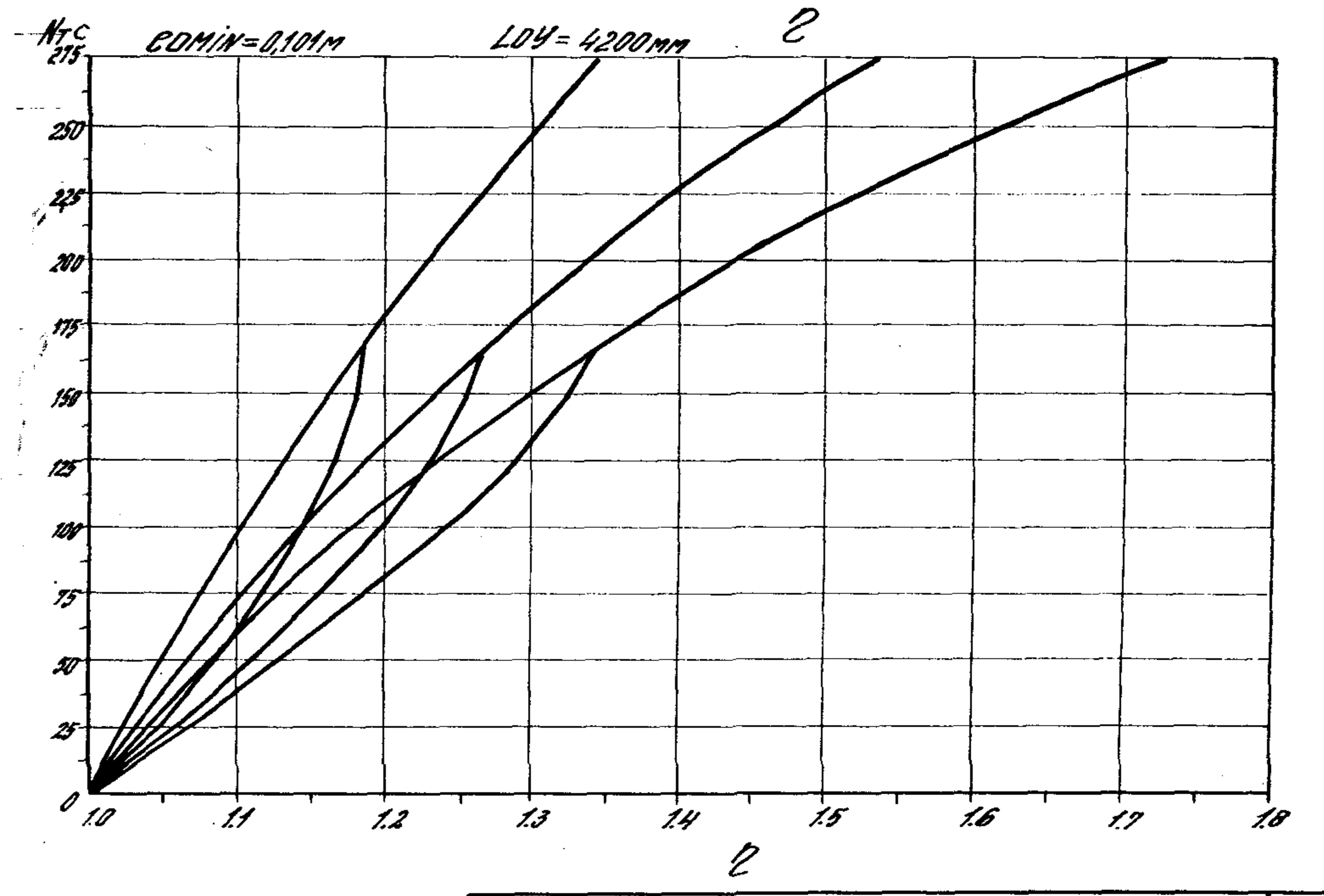
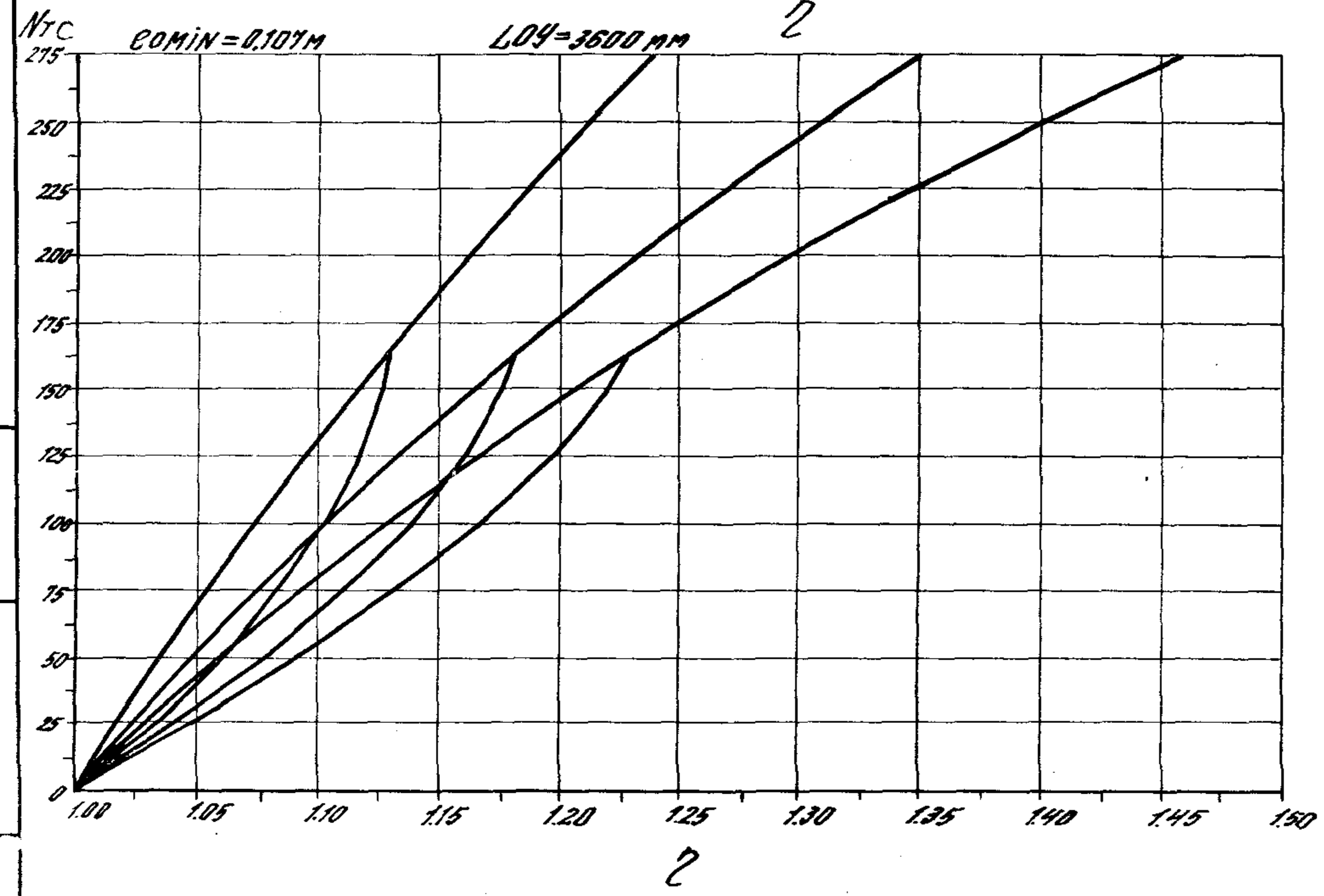
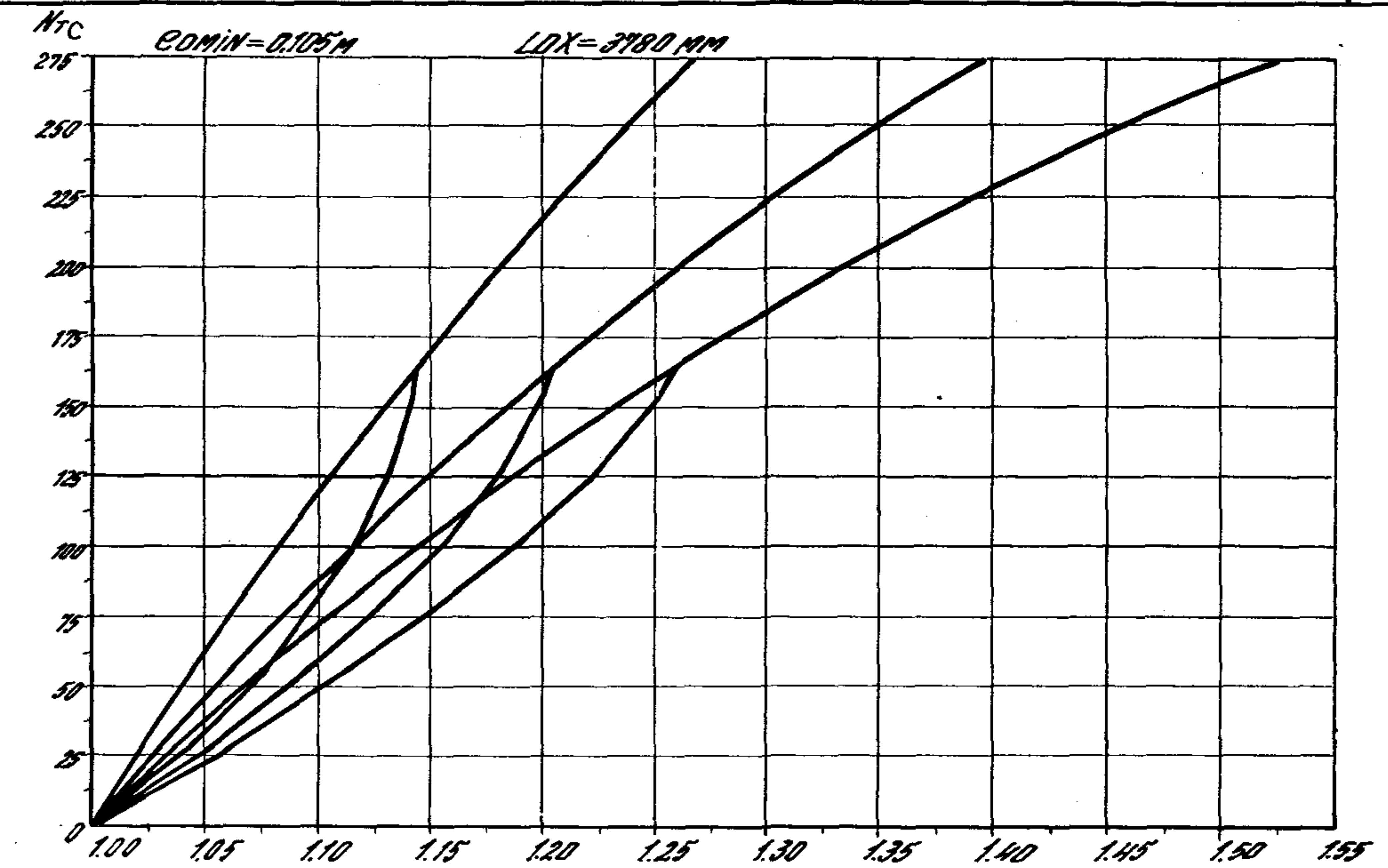
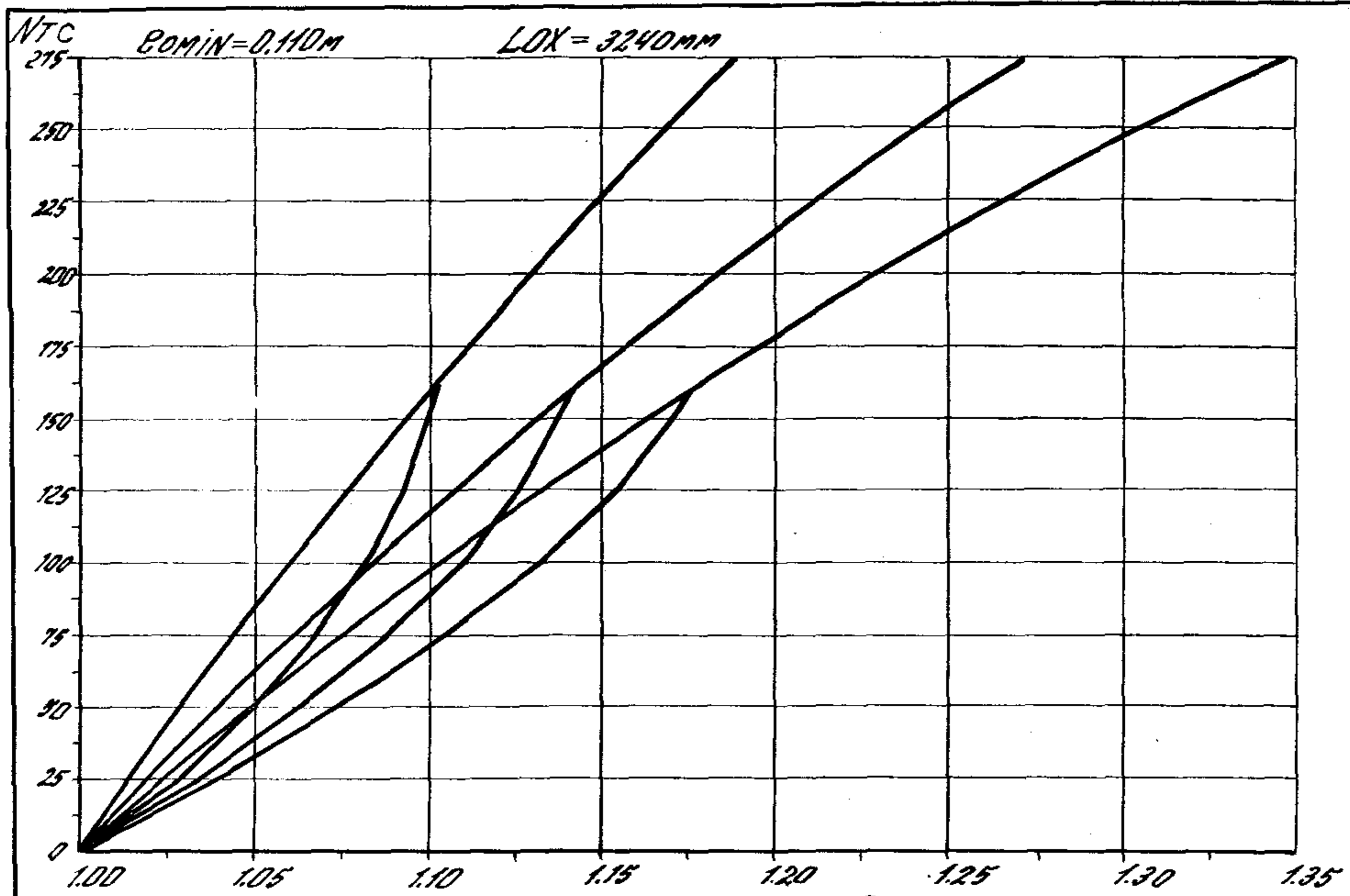

1.820.1-4 0-9 002

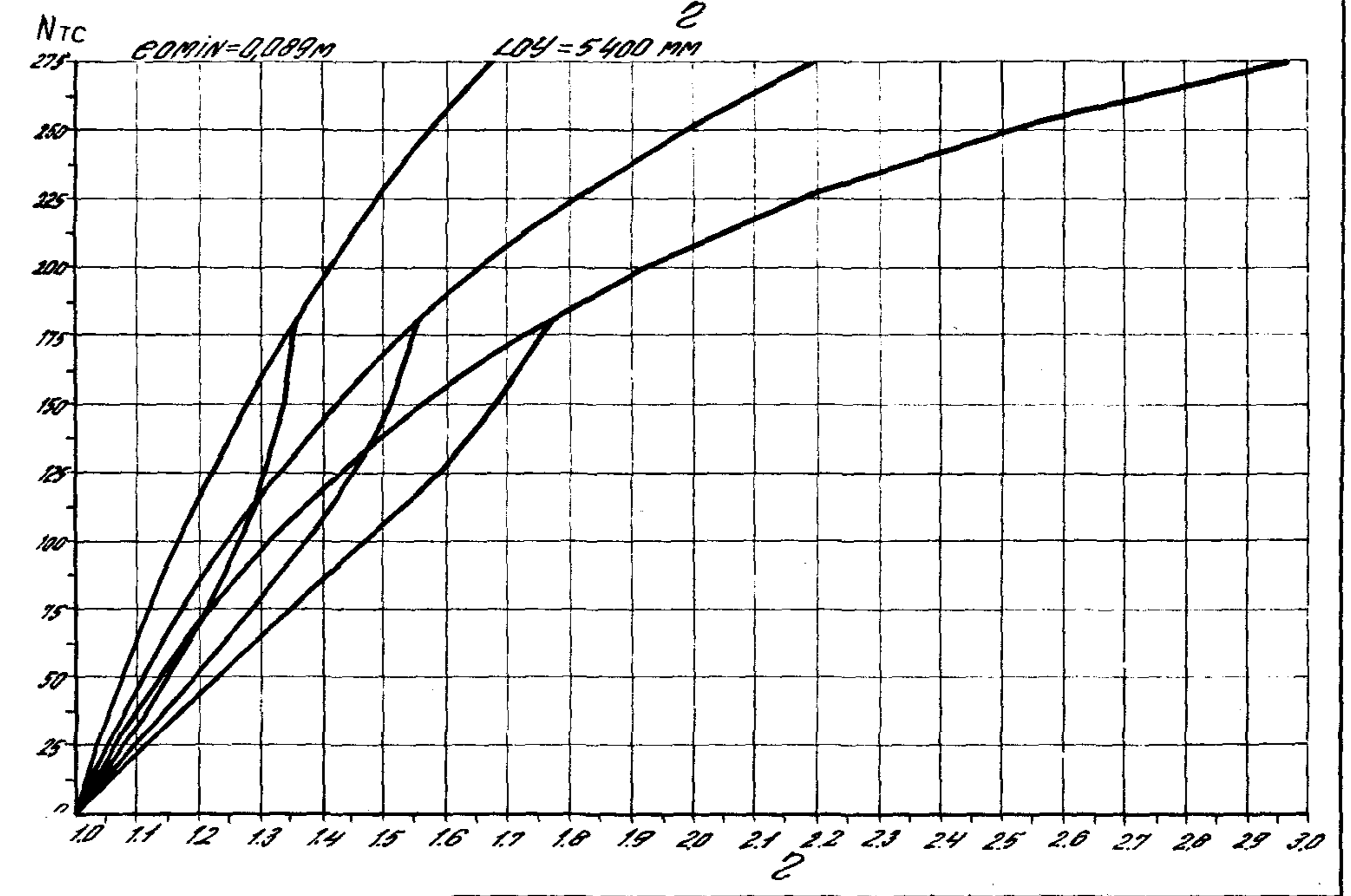
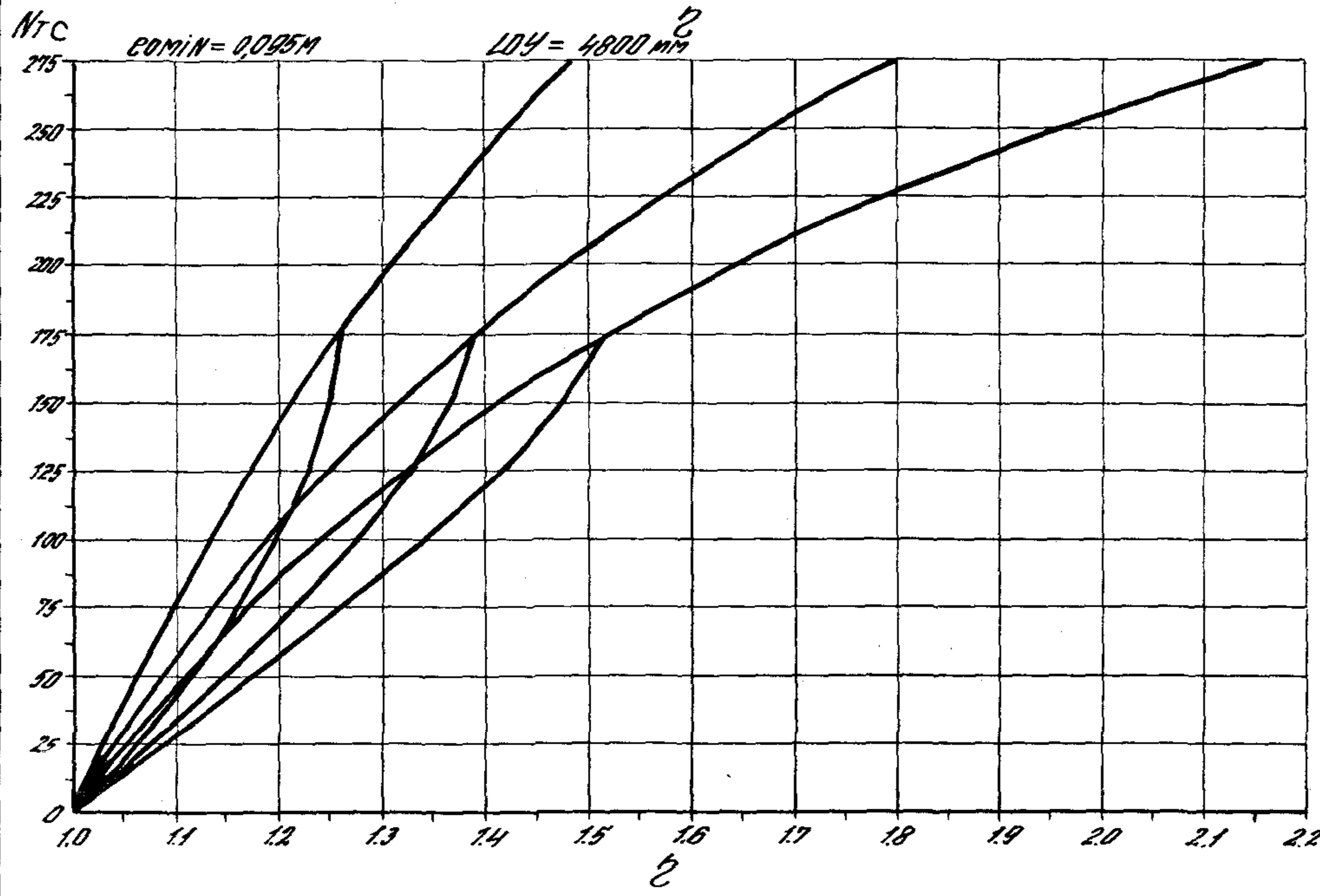
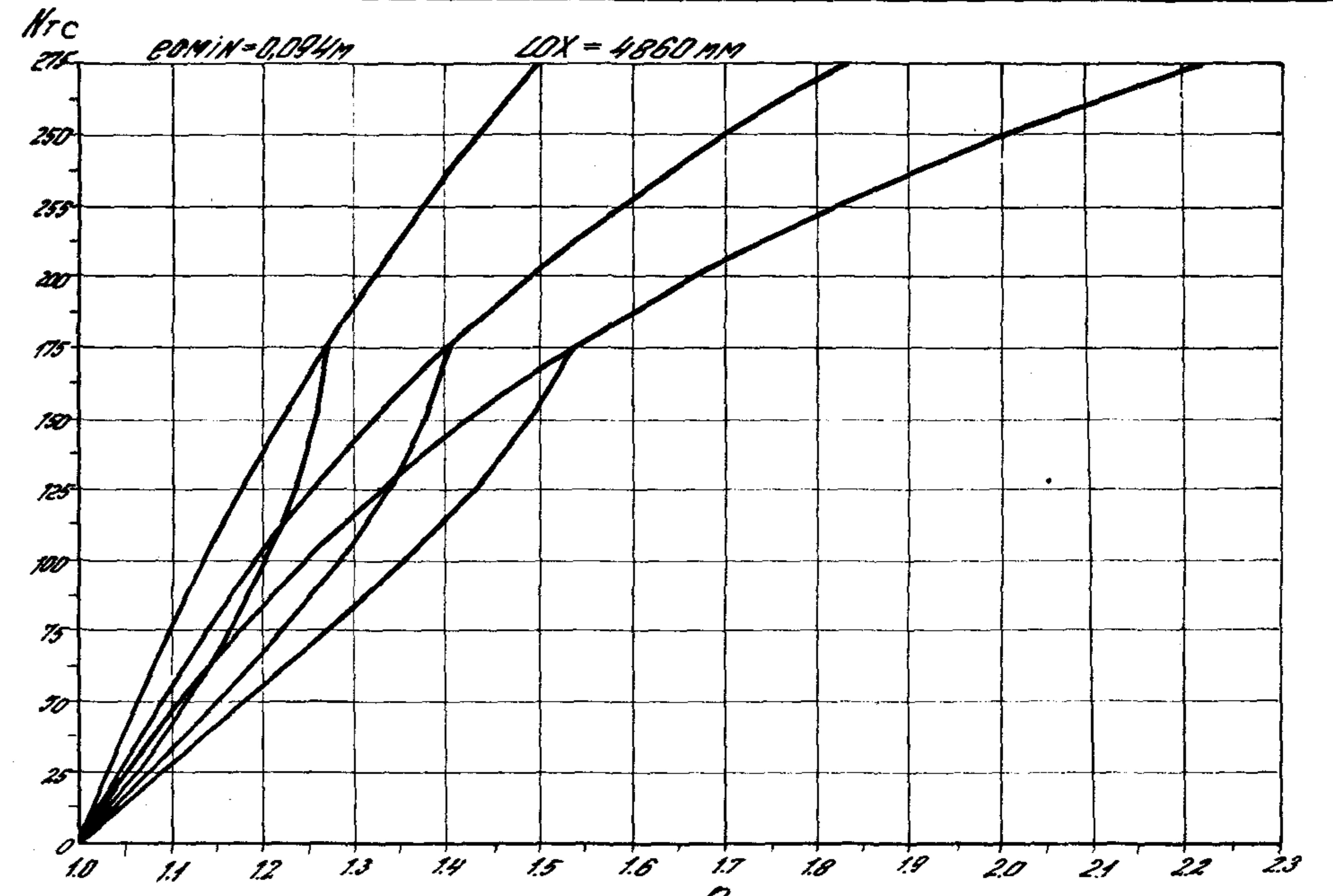
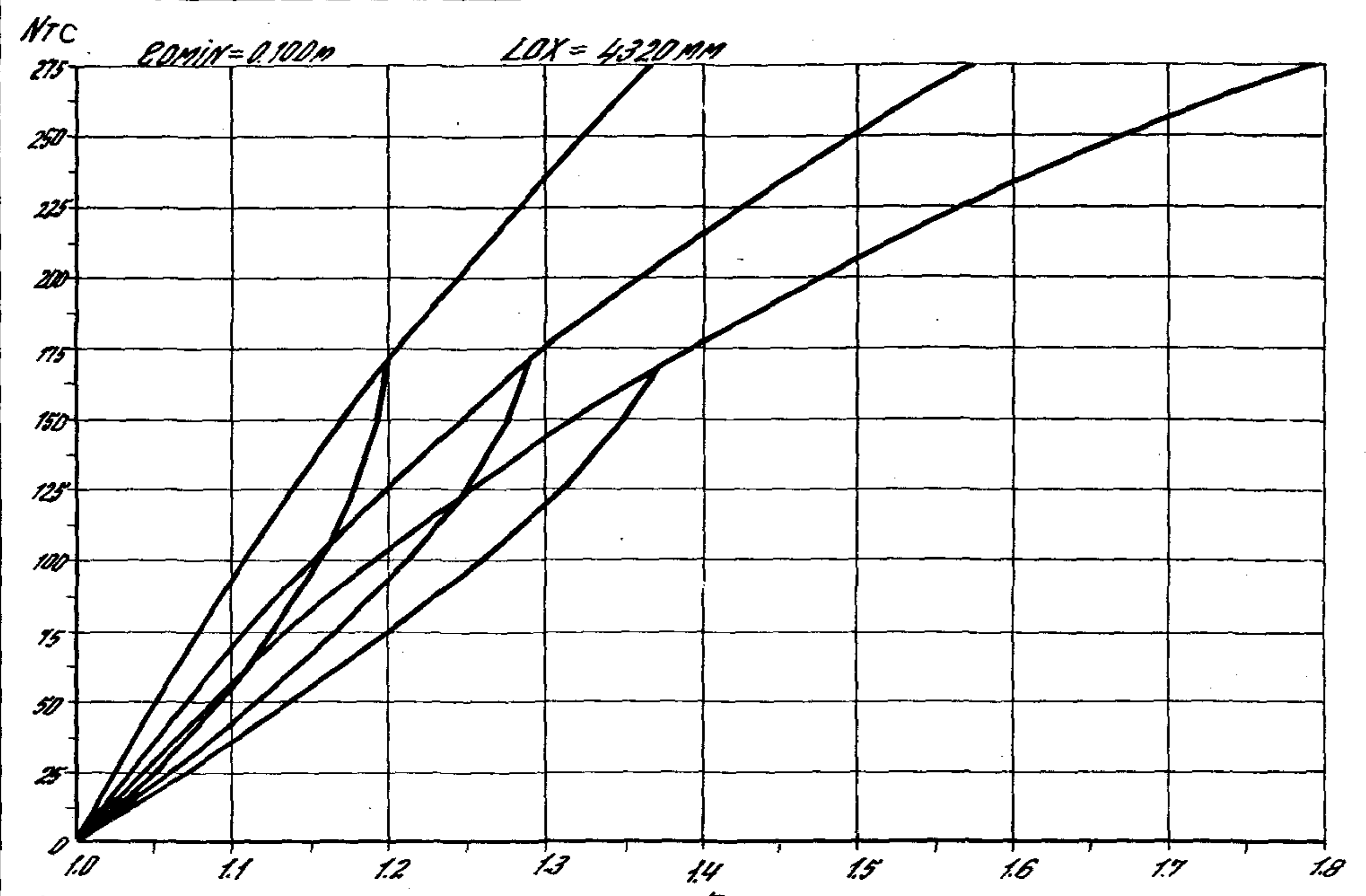

1.020. 1-4 0-9 002 SUCT 75

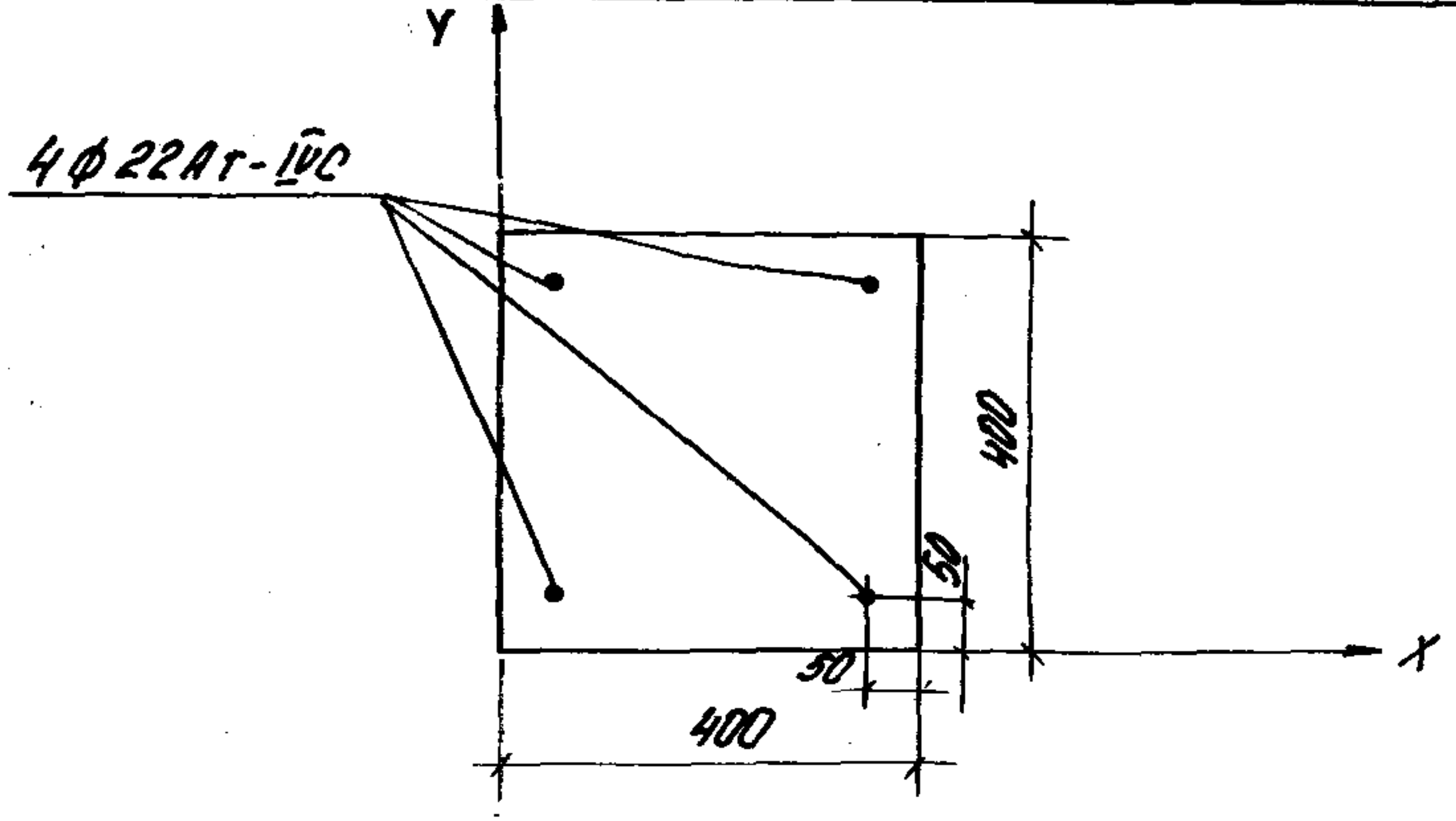
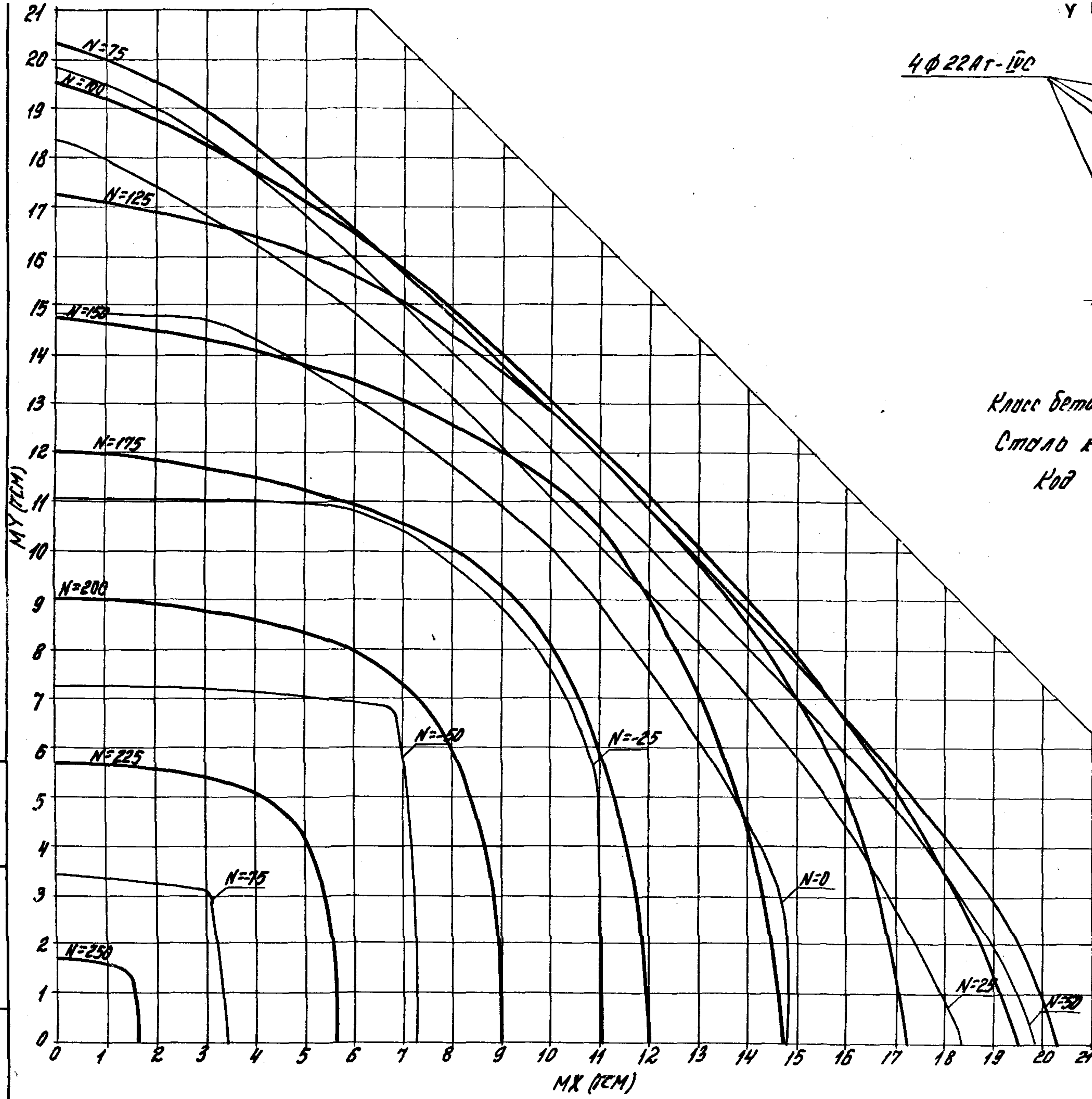

Класс бетона В22.5 ($R_b = 11.7 \text{ МПа}$ при учете $\gamma_{B2} = 0.90$)
 Сталь класса Ат-IV
 Код сечения - 1108

Лист № 001 в 1 (1/1) 10/10/2010 11:00:00

1.020.1-4 0-9 002

Лист
77

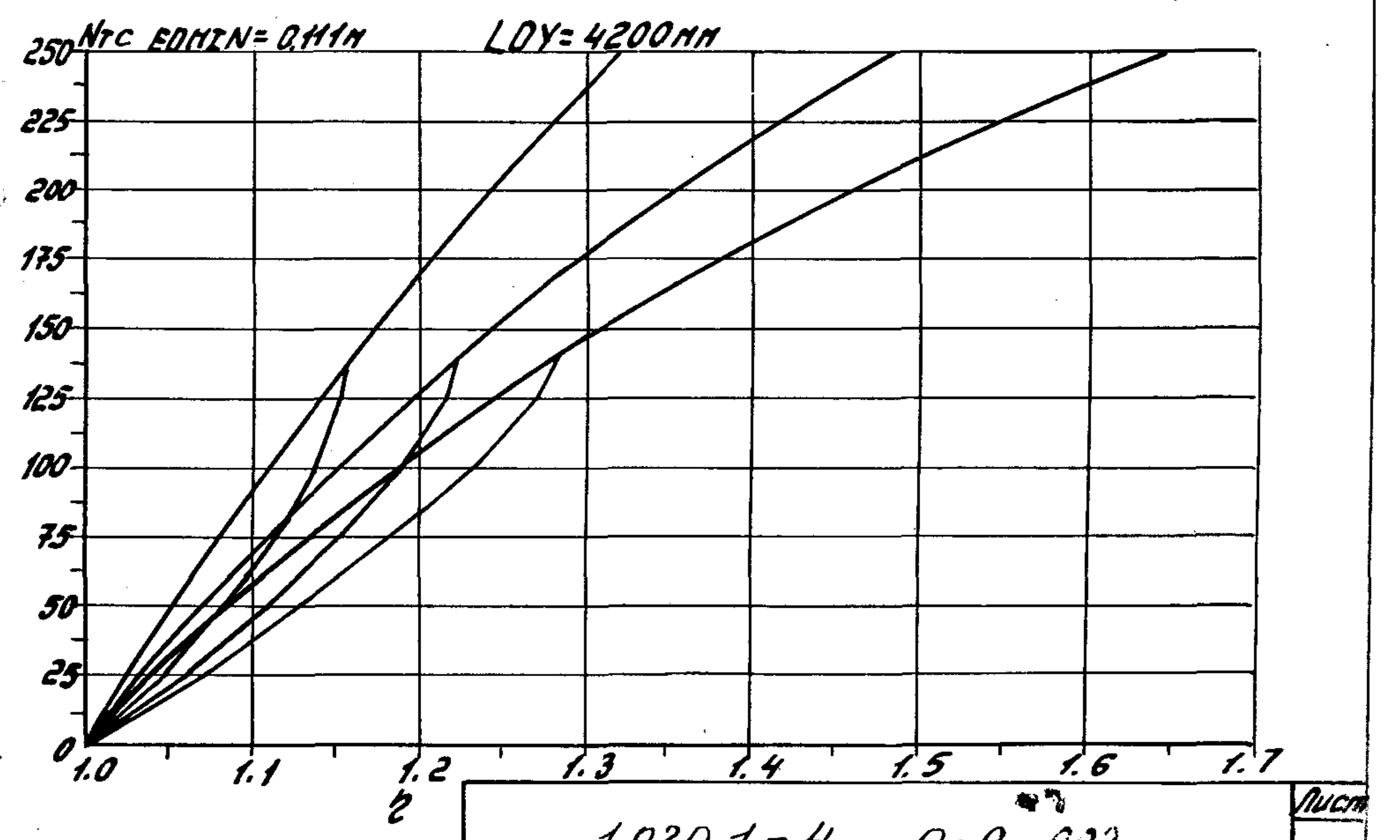
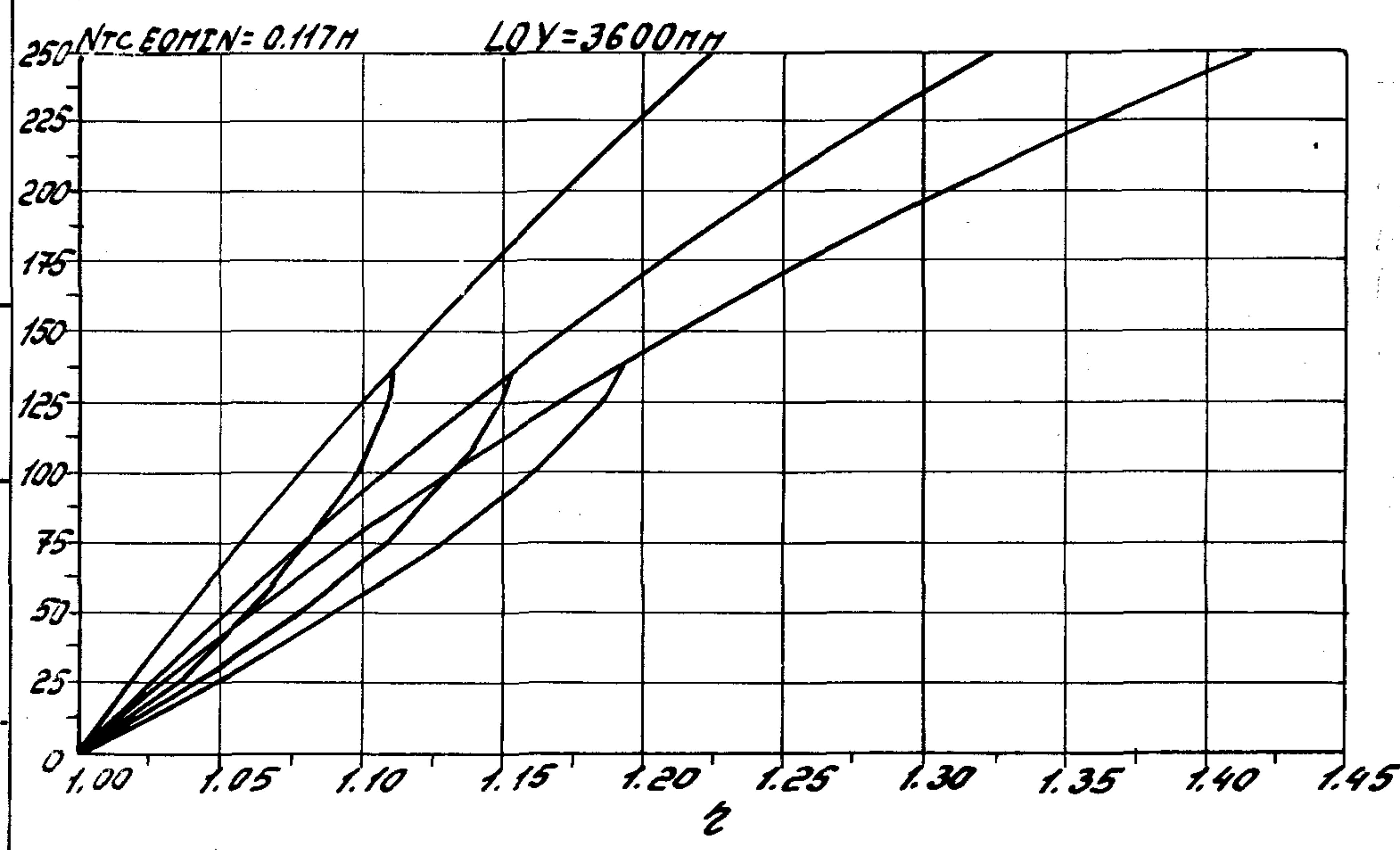
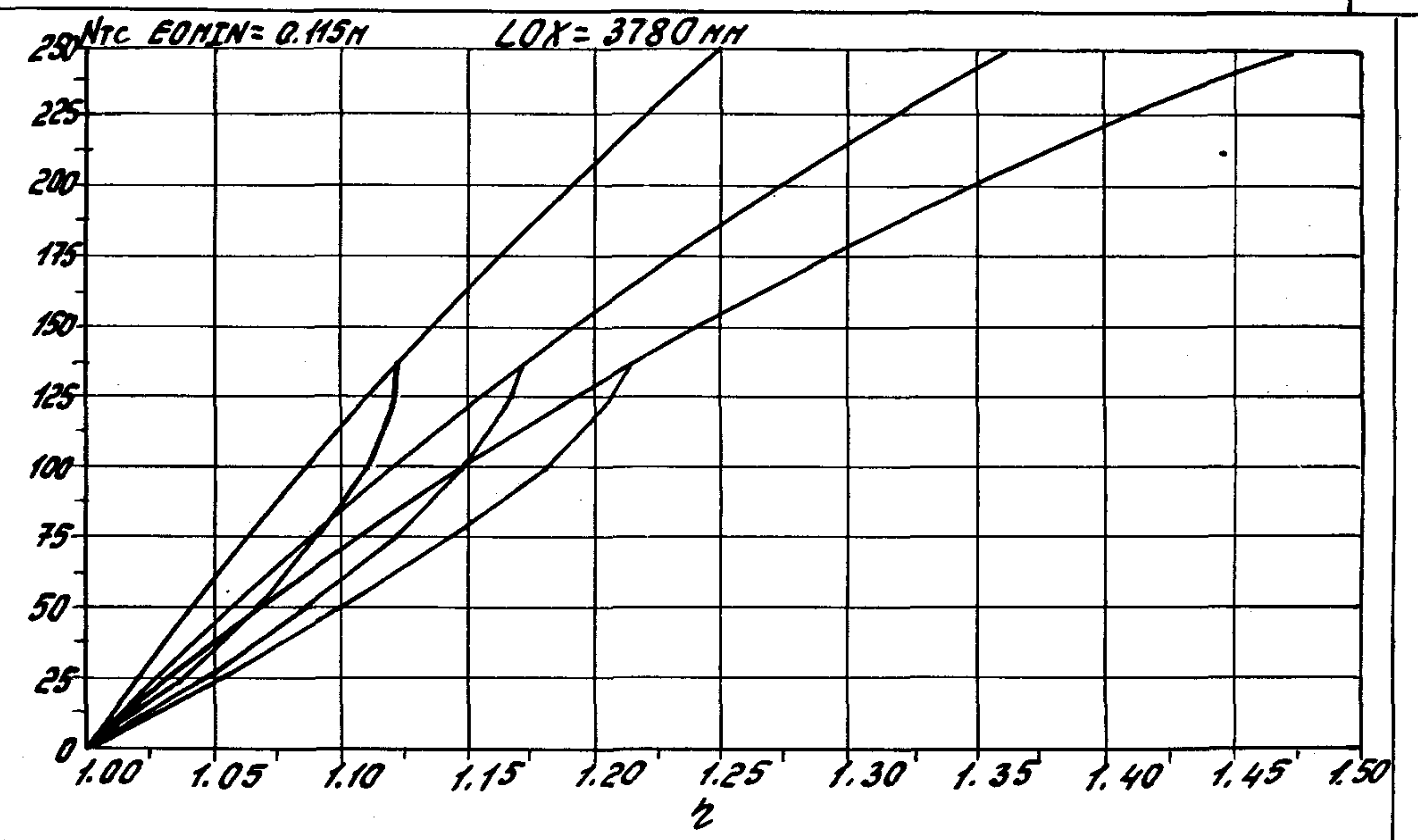
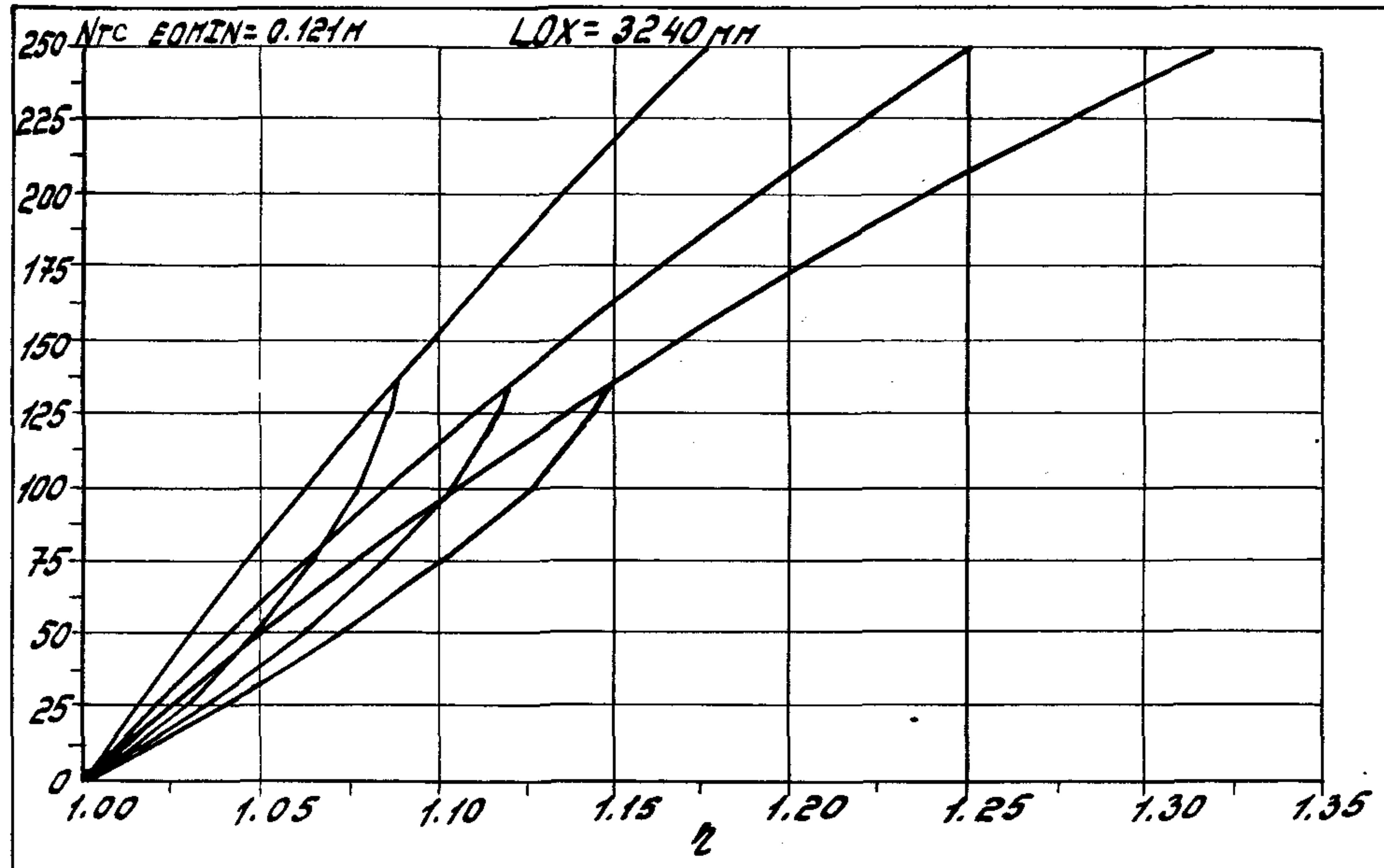

Умк. № 22. Показатели

1.020.1-4 0-9 002

Лучм
78

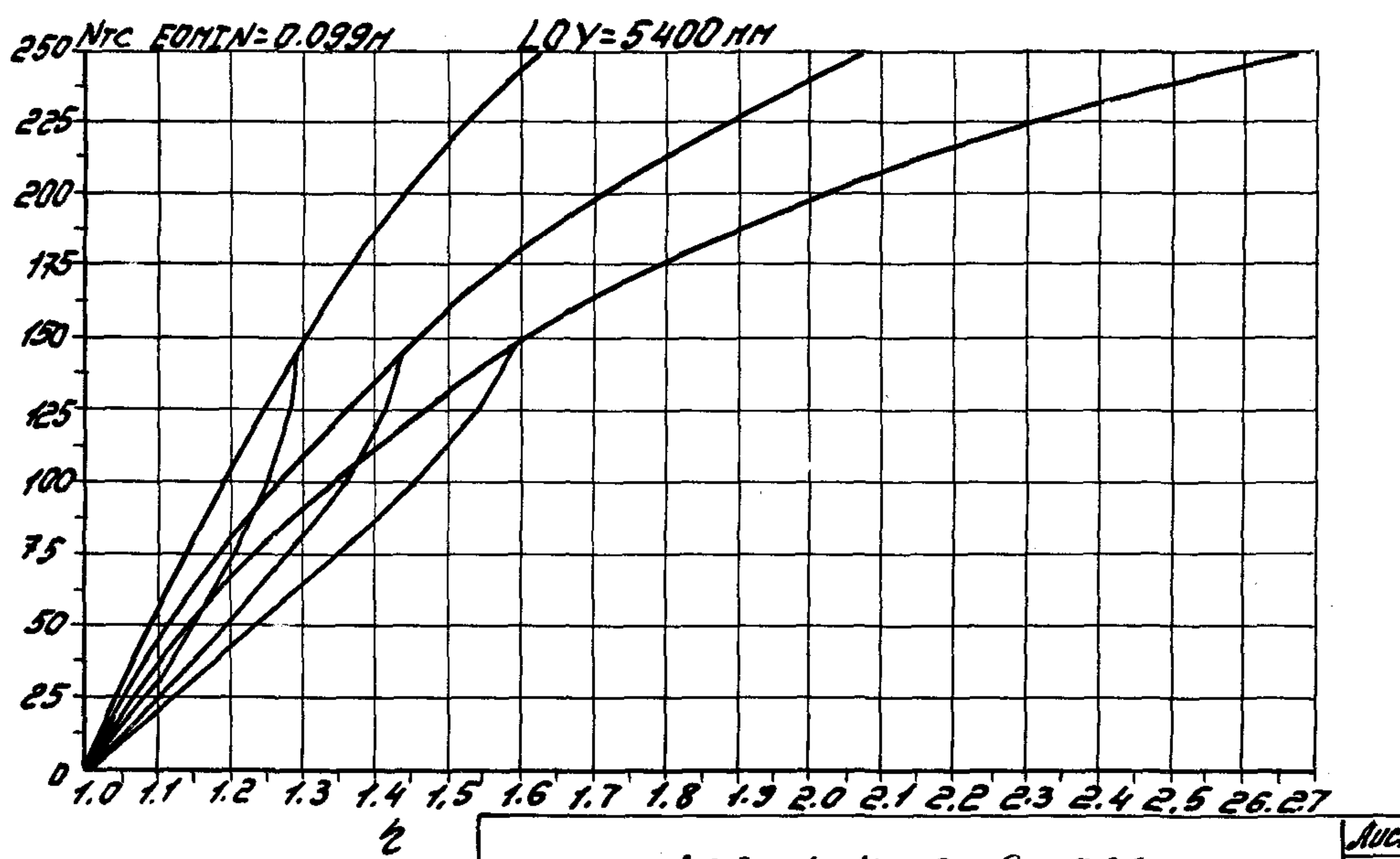
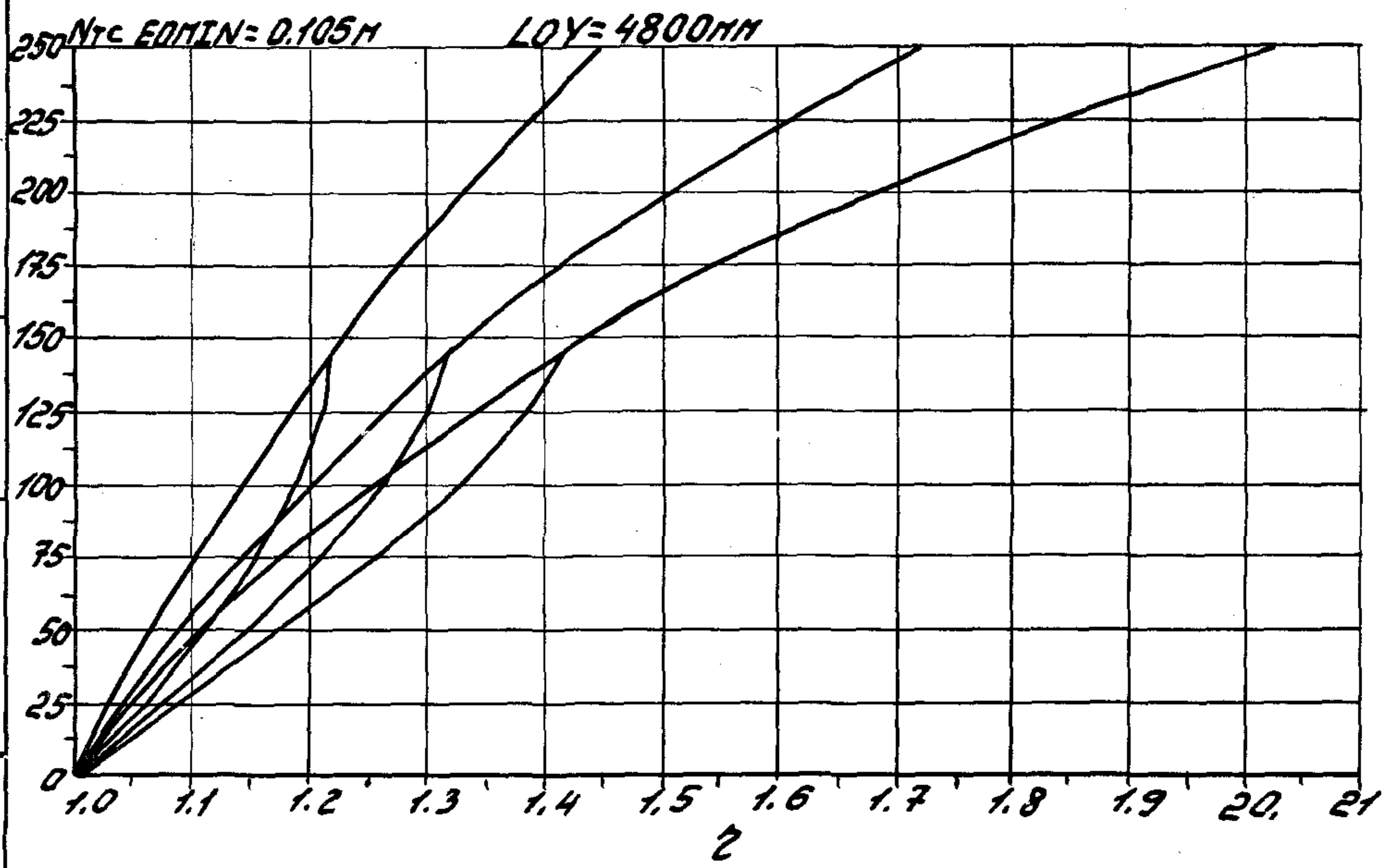
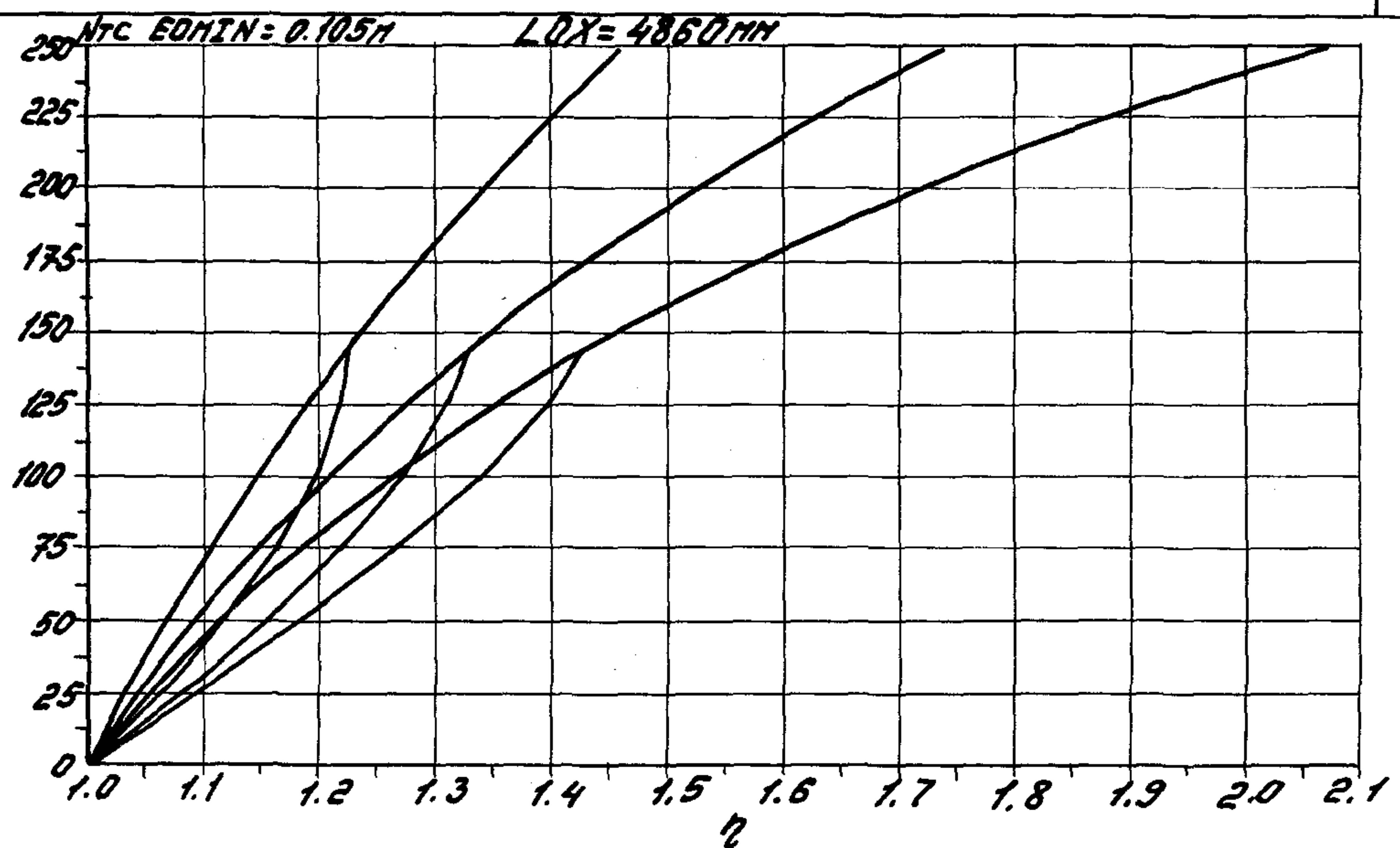
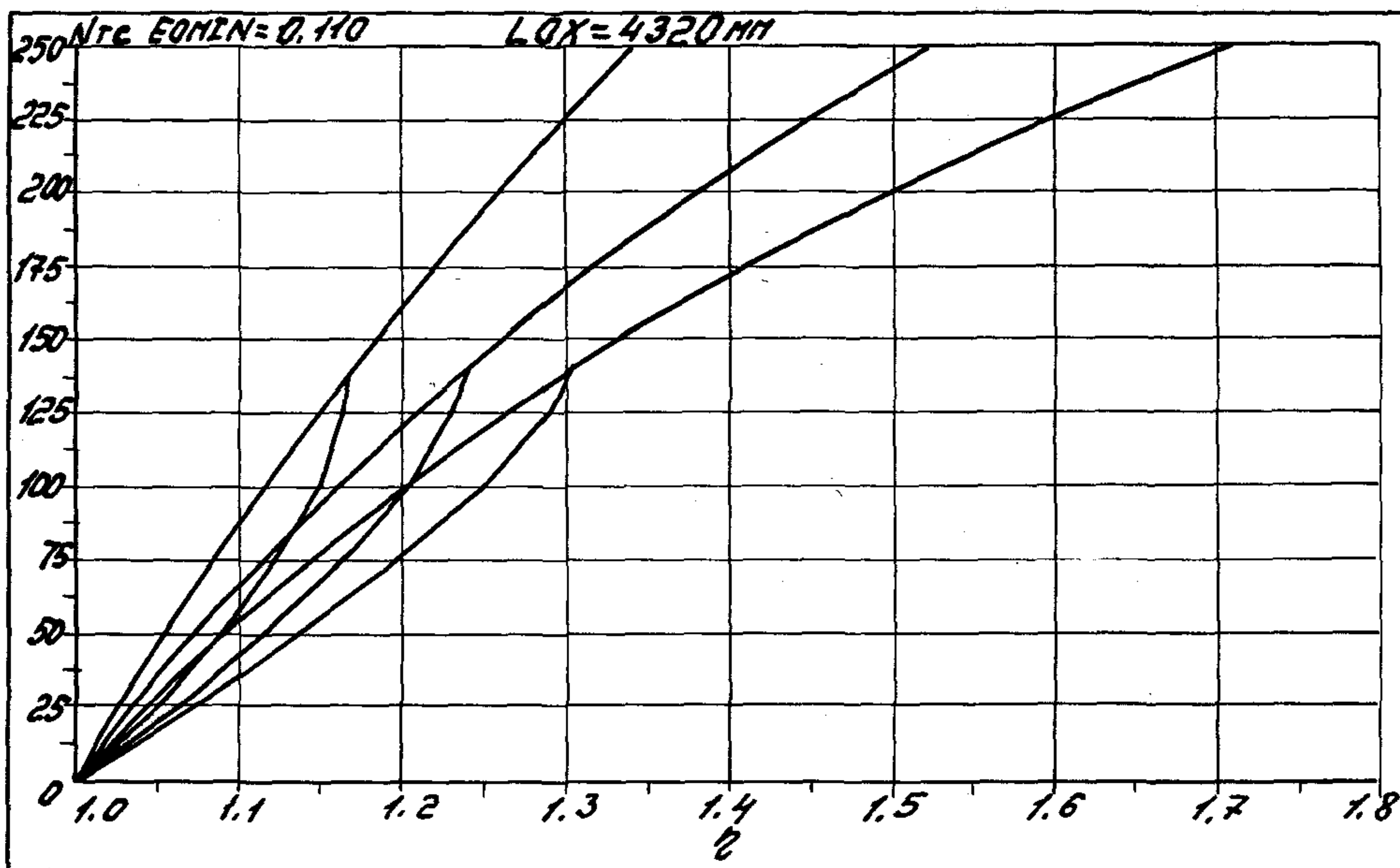

1.020.1-4 0-9 002

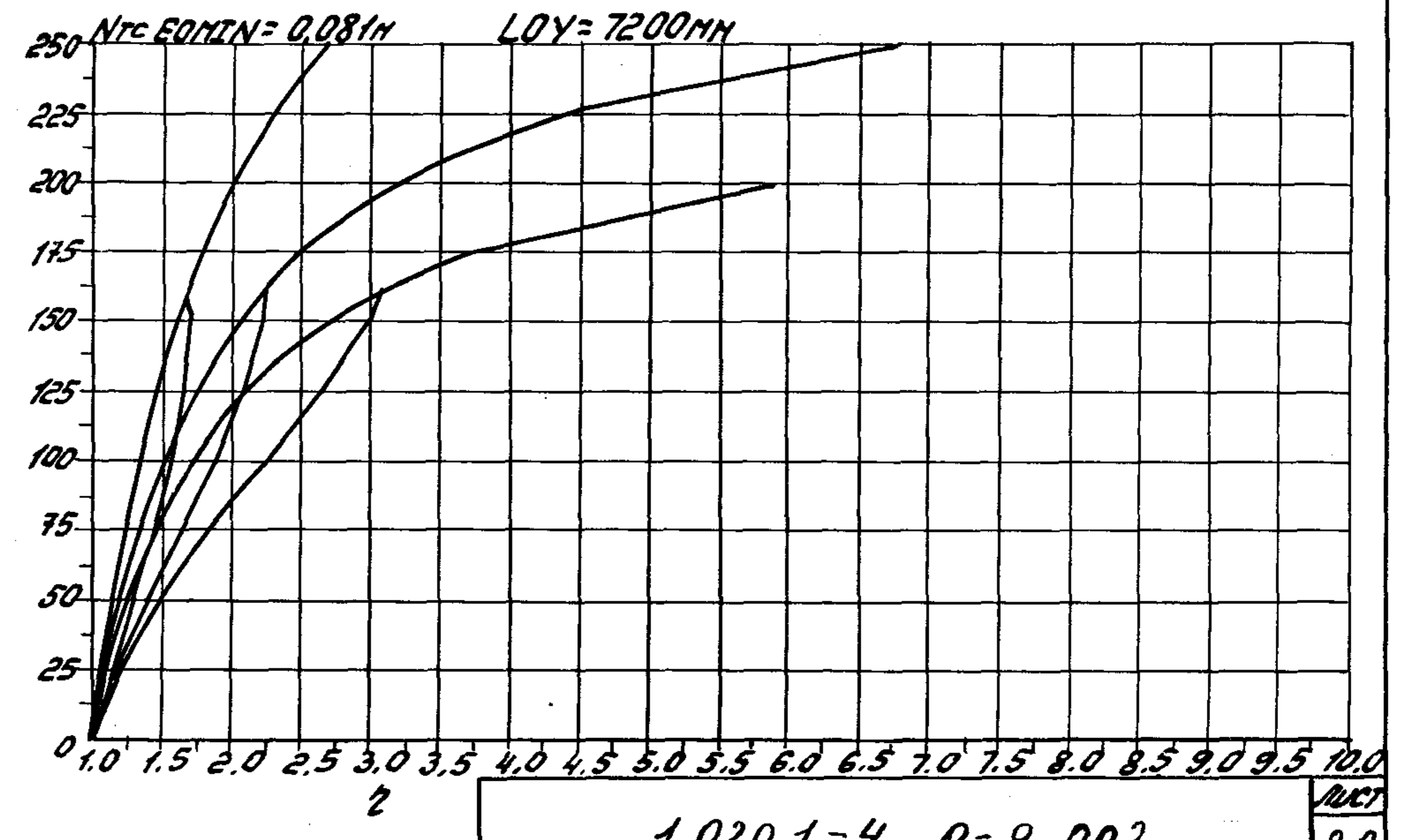
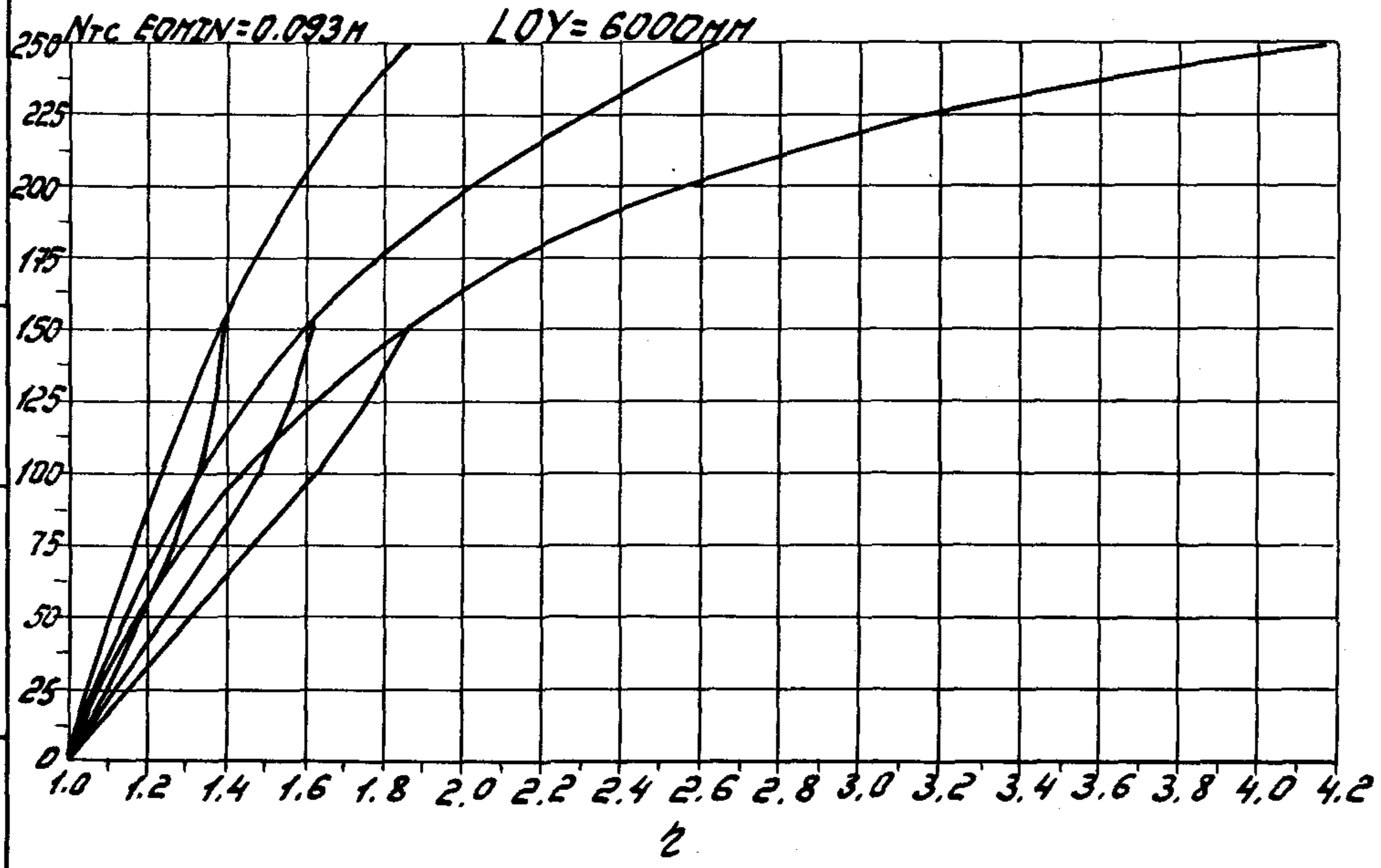
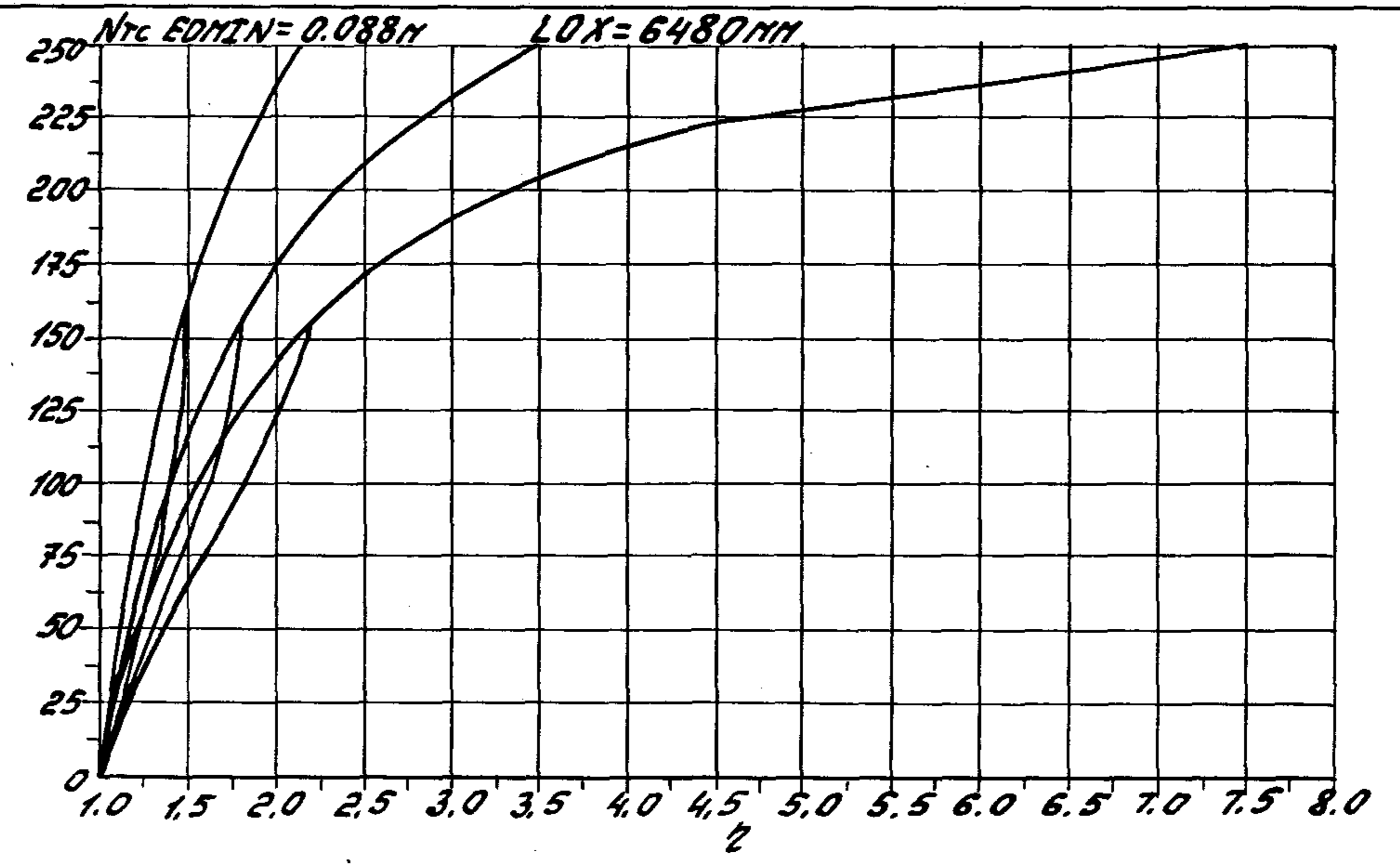
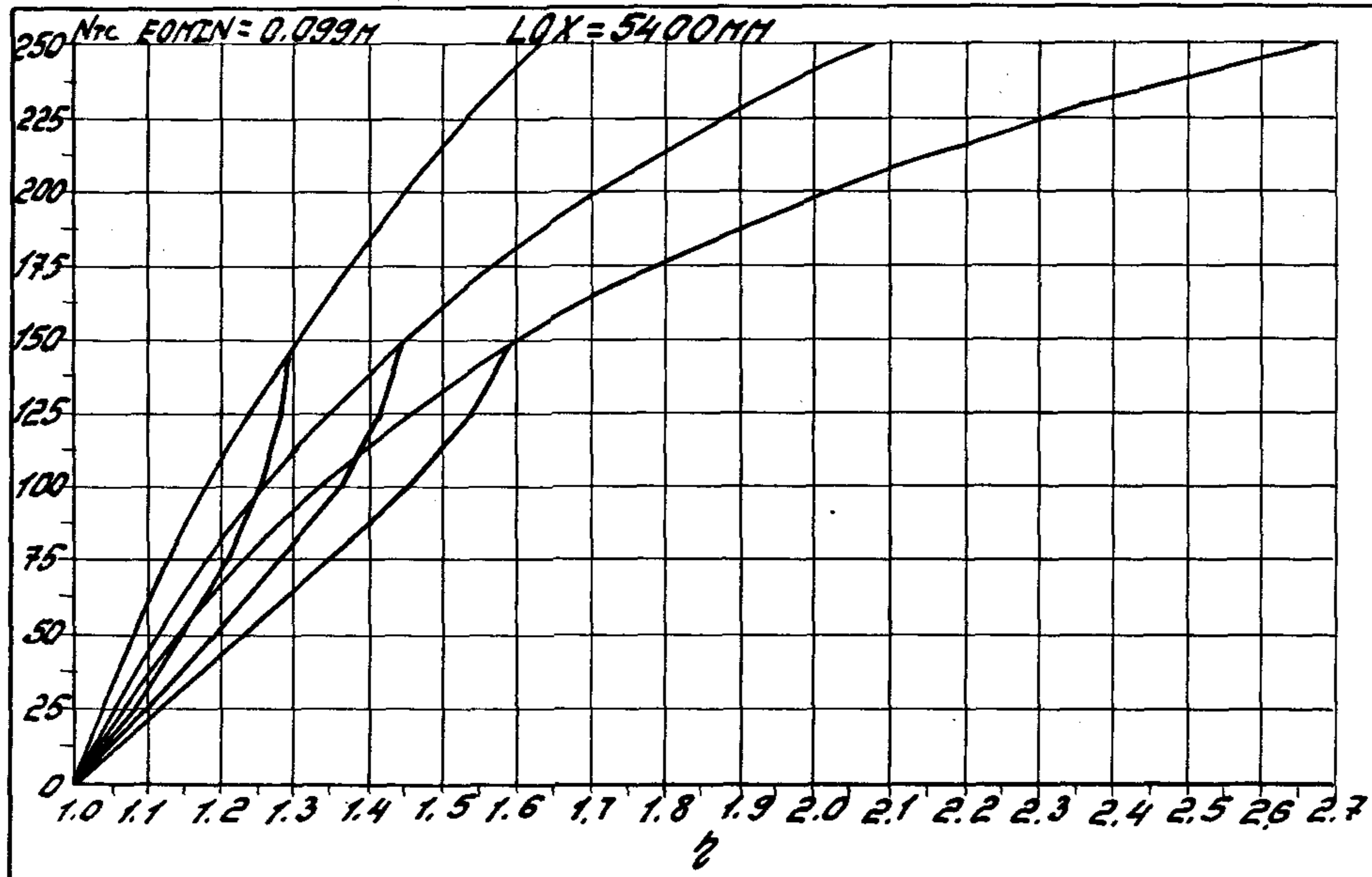

Лит. № 10001. Подпись и дата. В. Золот. 1987

1.020.1-4 0-9 002 80

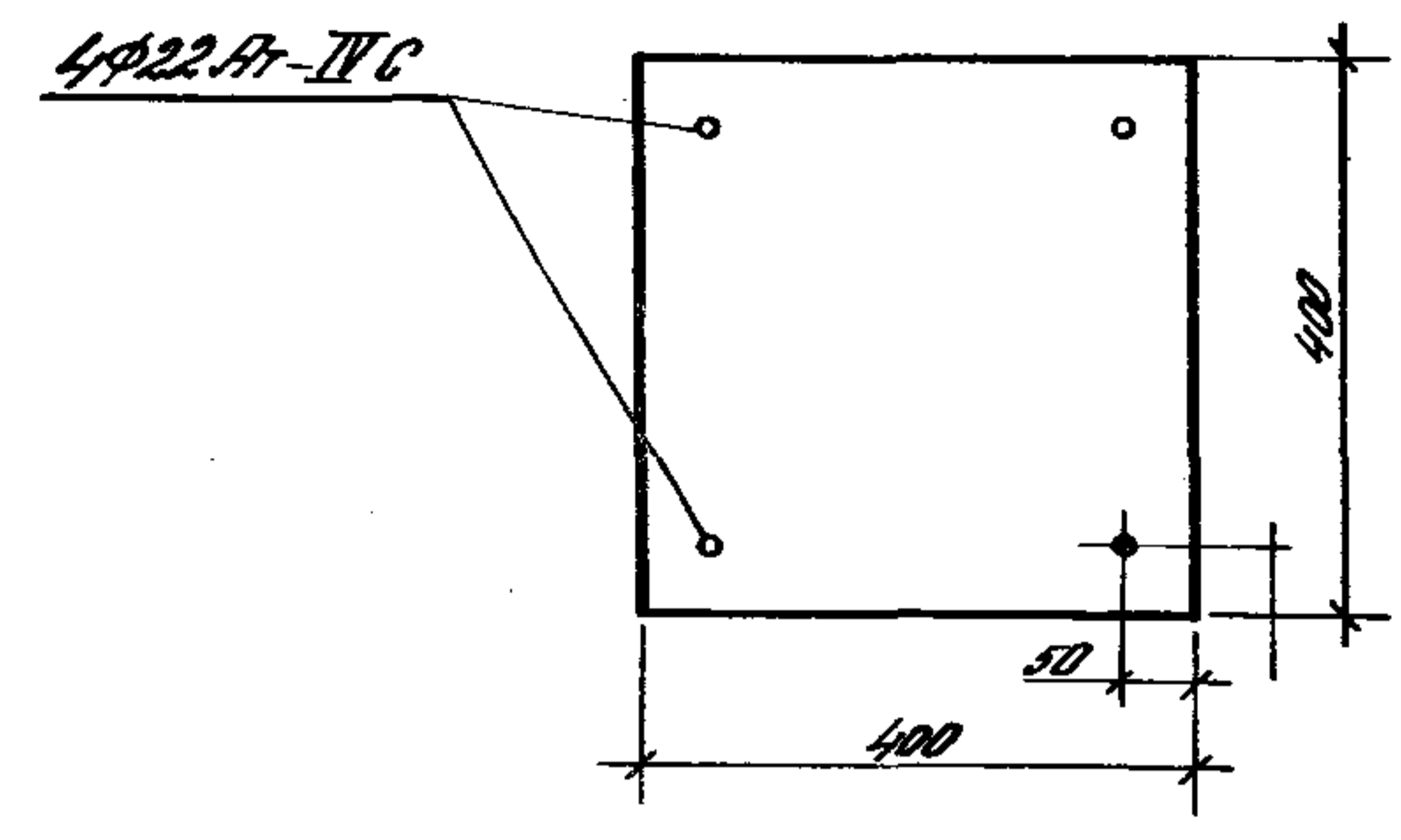
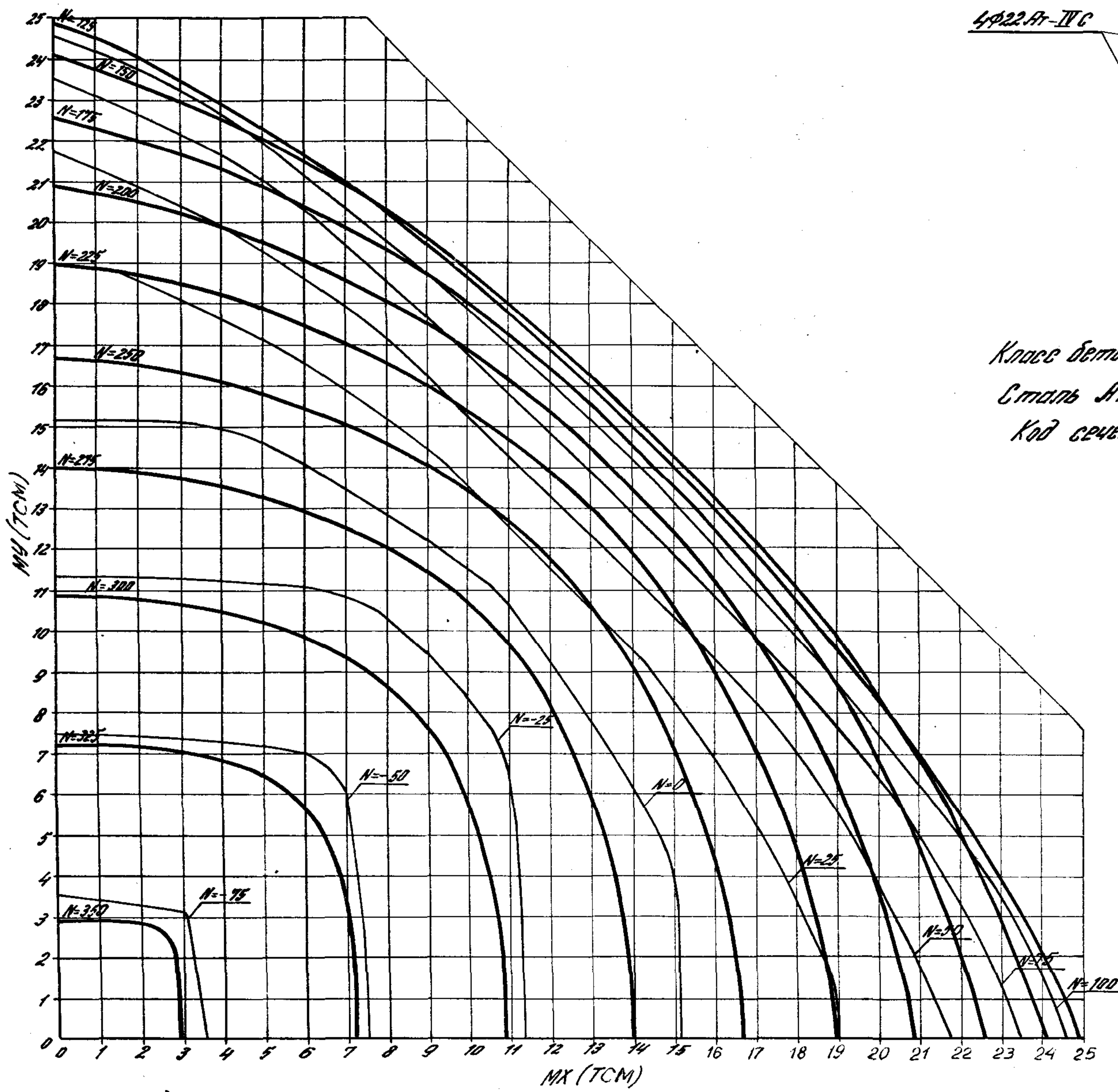

Класс бетона В30.0 ($R_b = 18,7$ МПа при учете $\gamma_{b2} = 1,10$)
 Сталь АТ-IV С
 Код сечения - 111а

Инж. А. Г. Гайдарь
 Подпись и дата
 2012.11.15

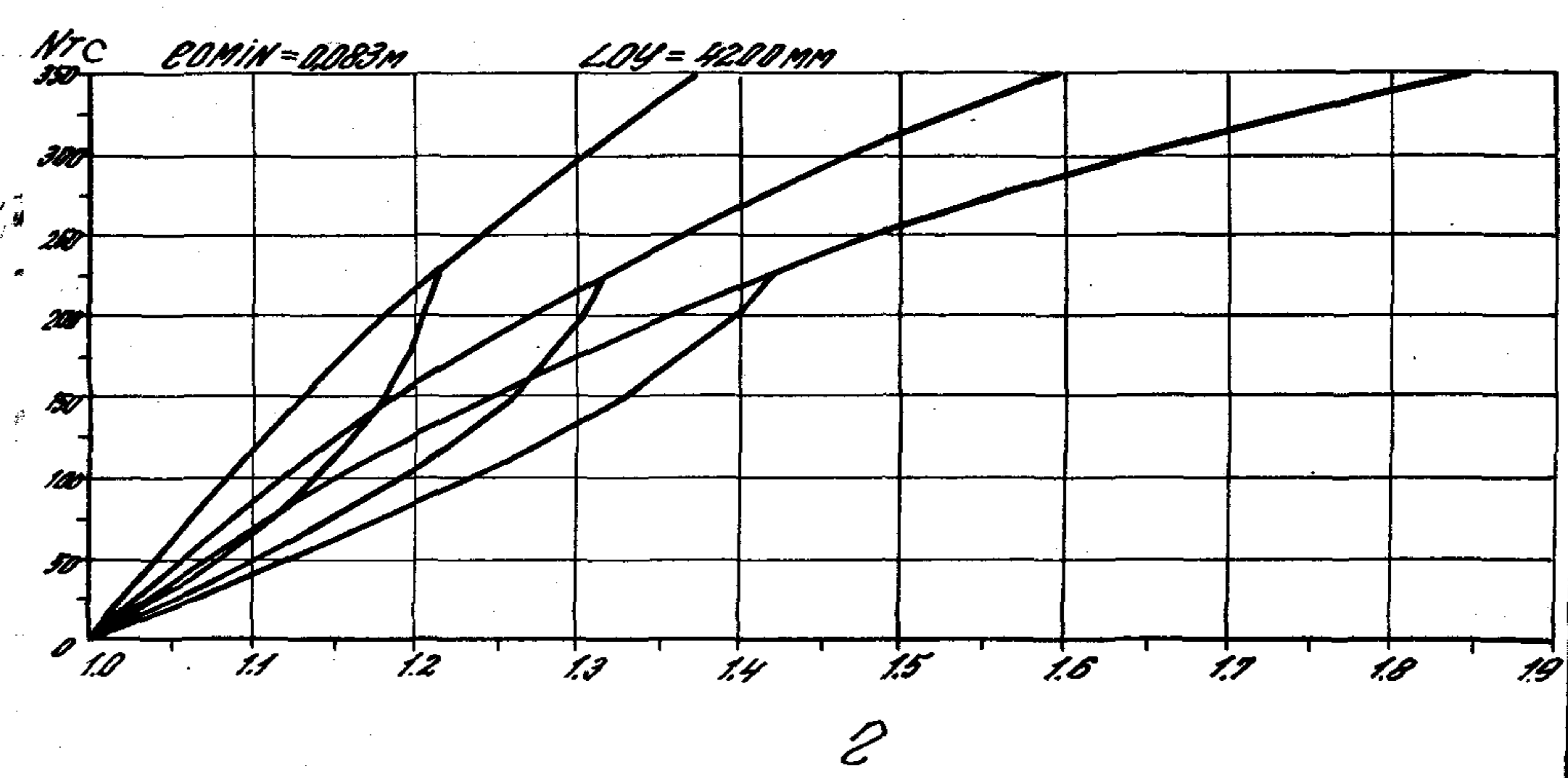
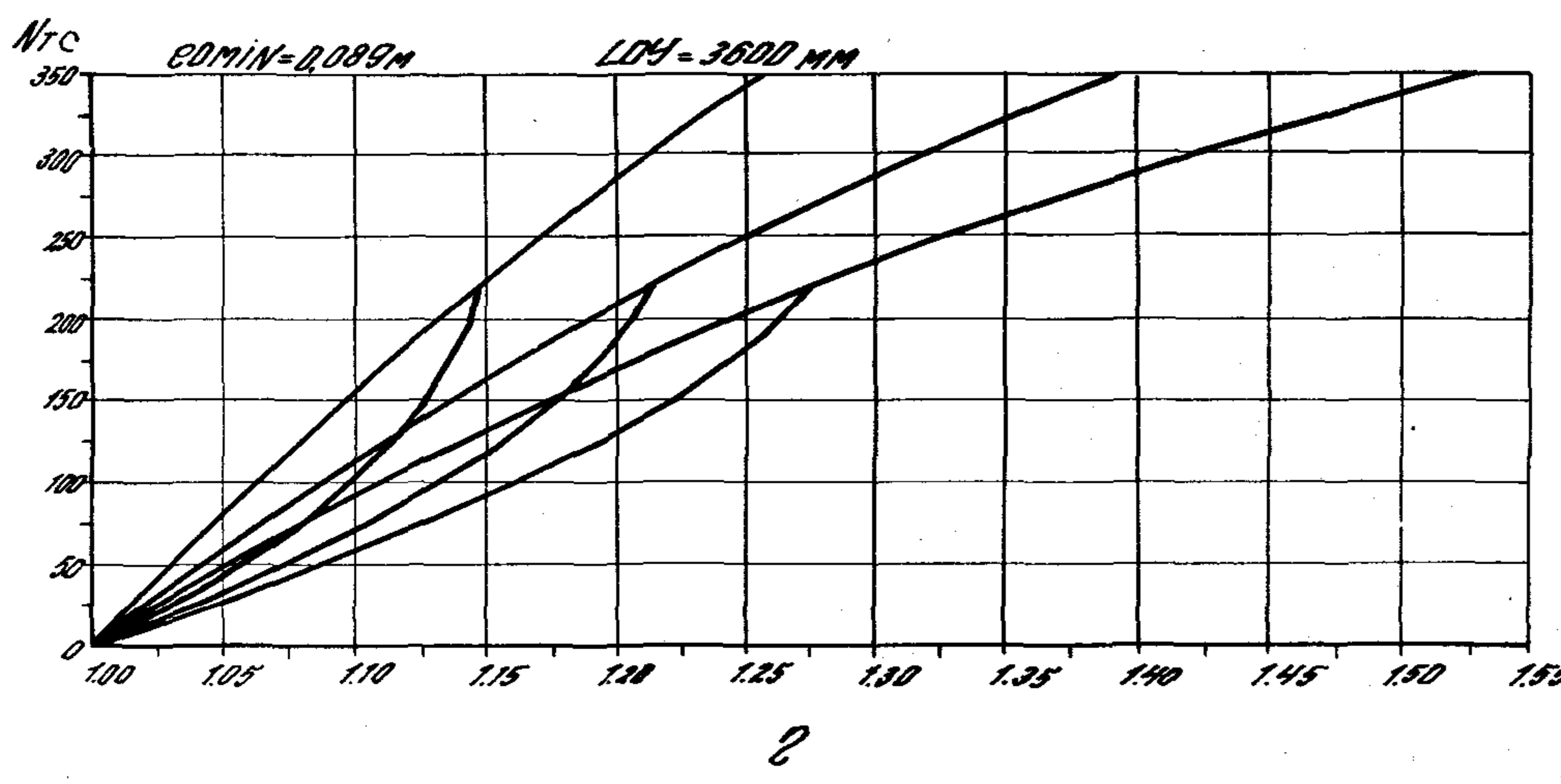
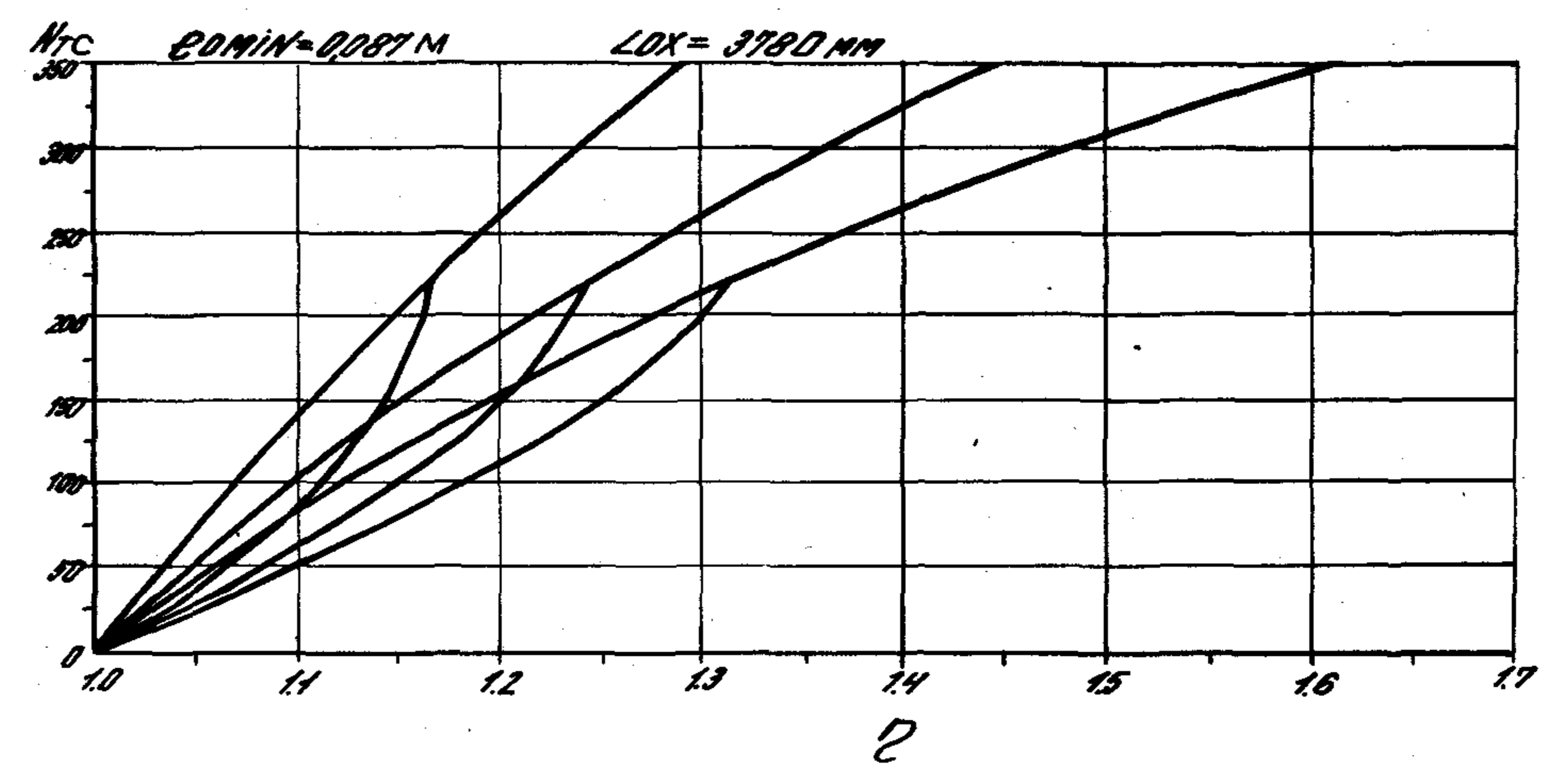
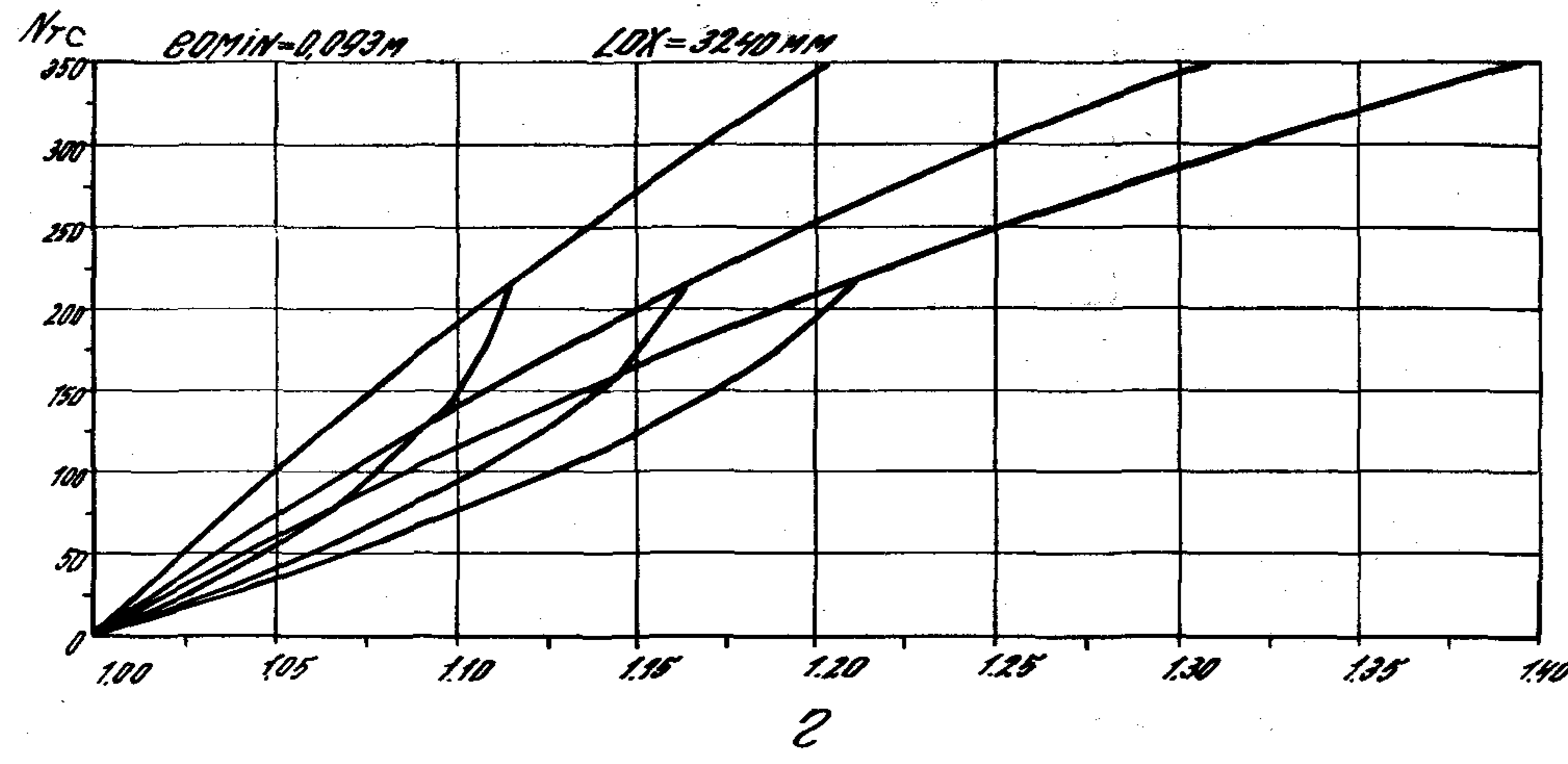

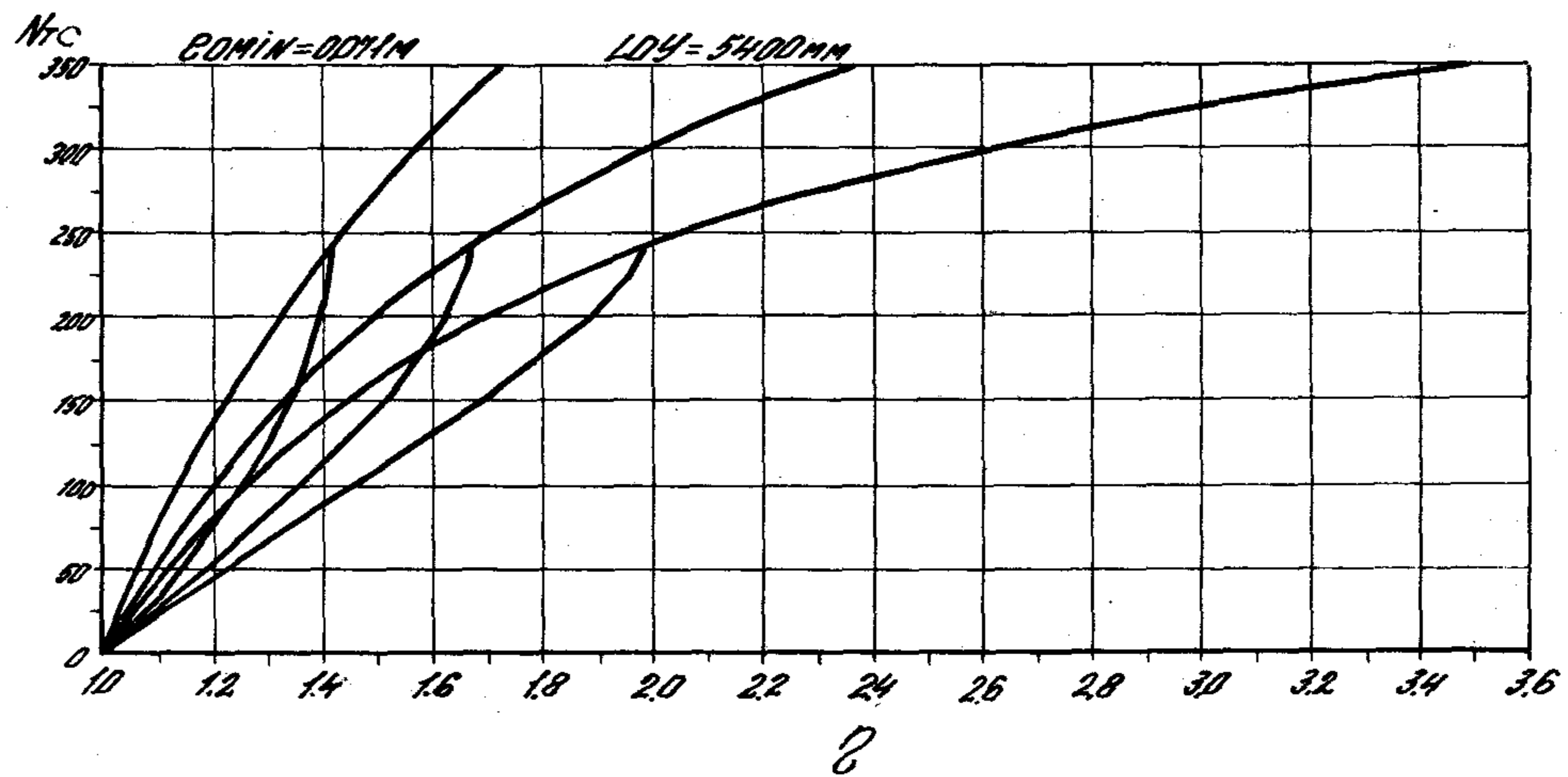
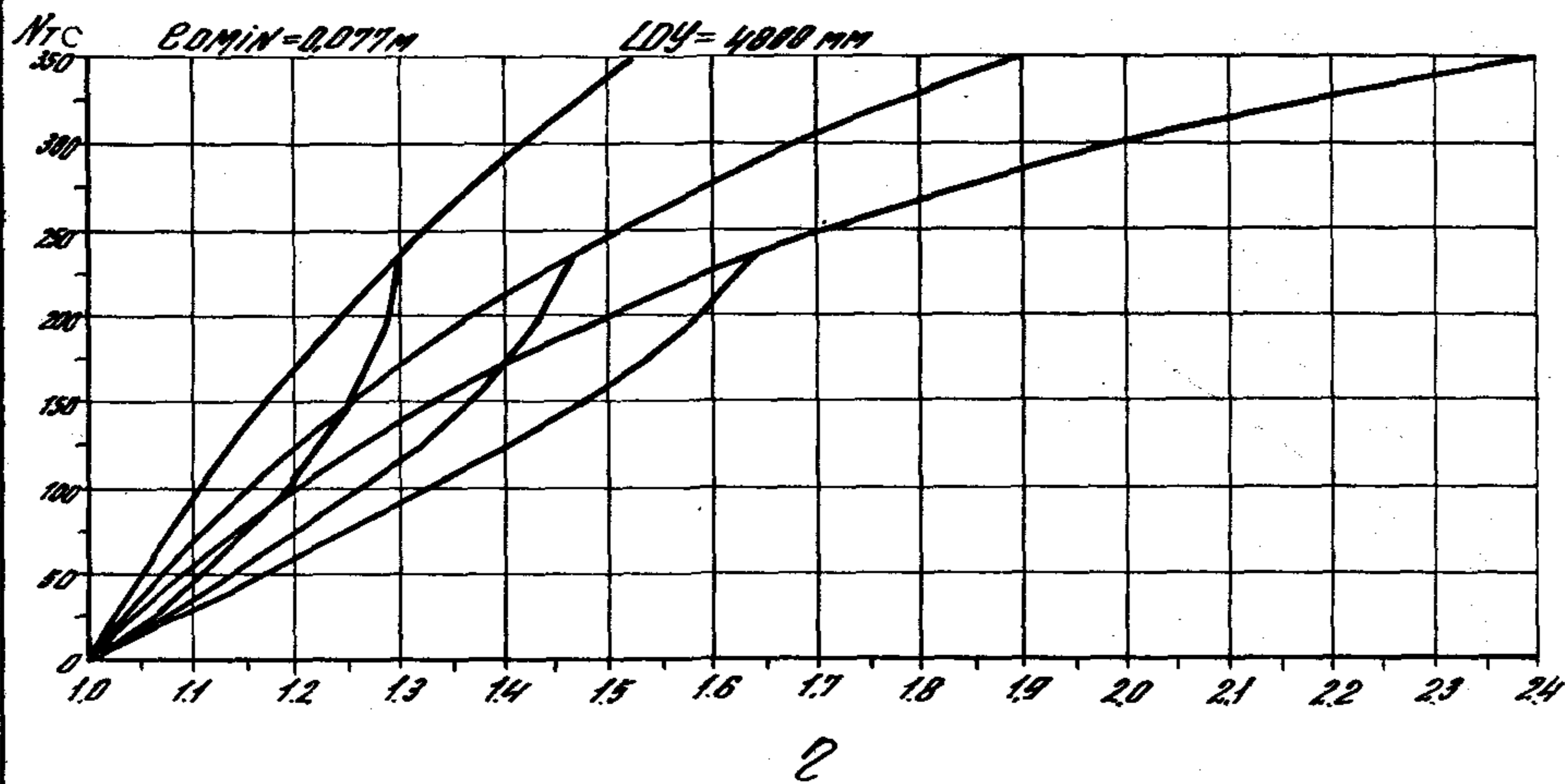
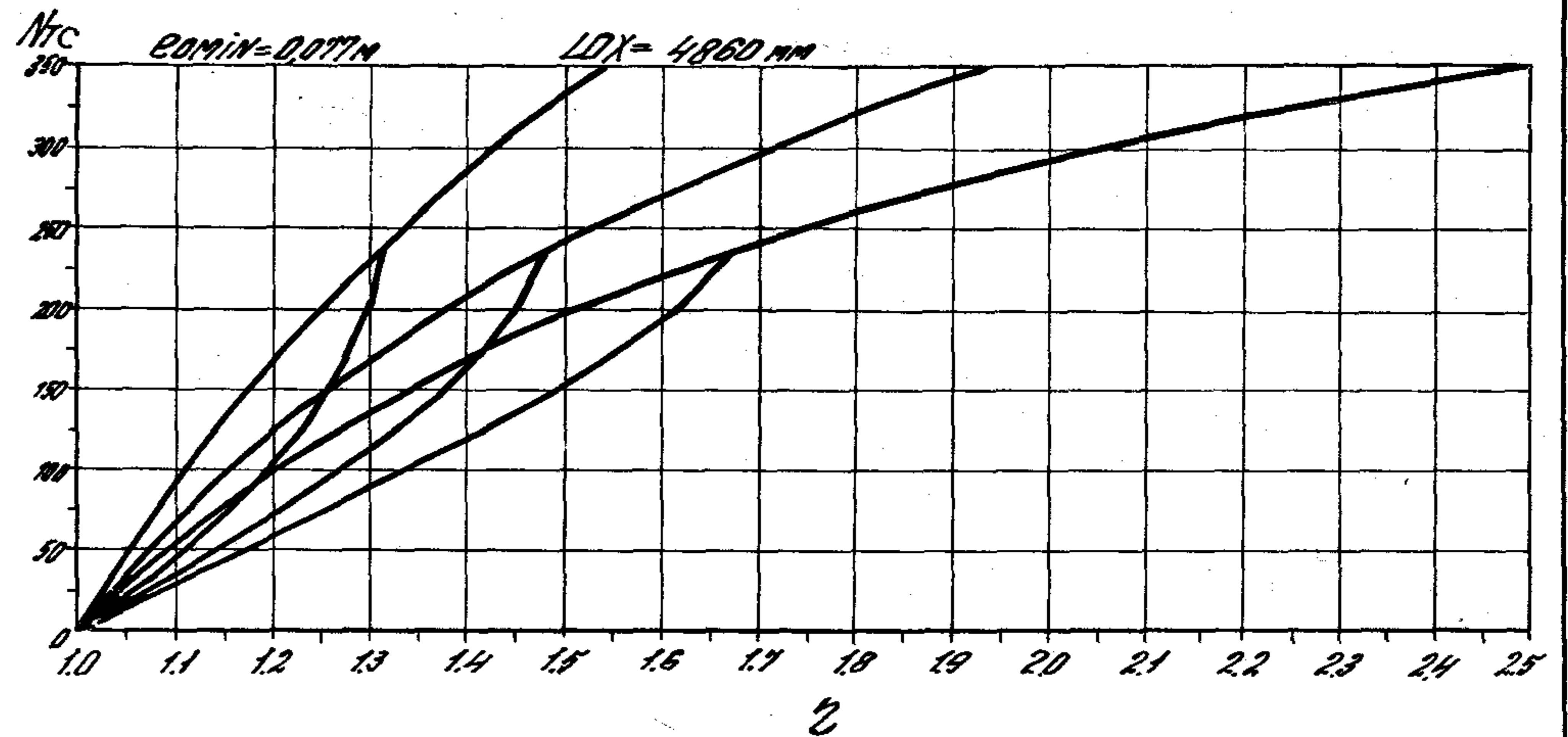
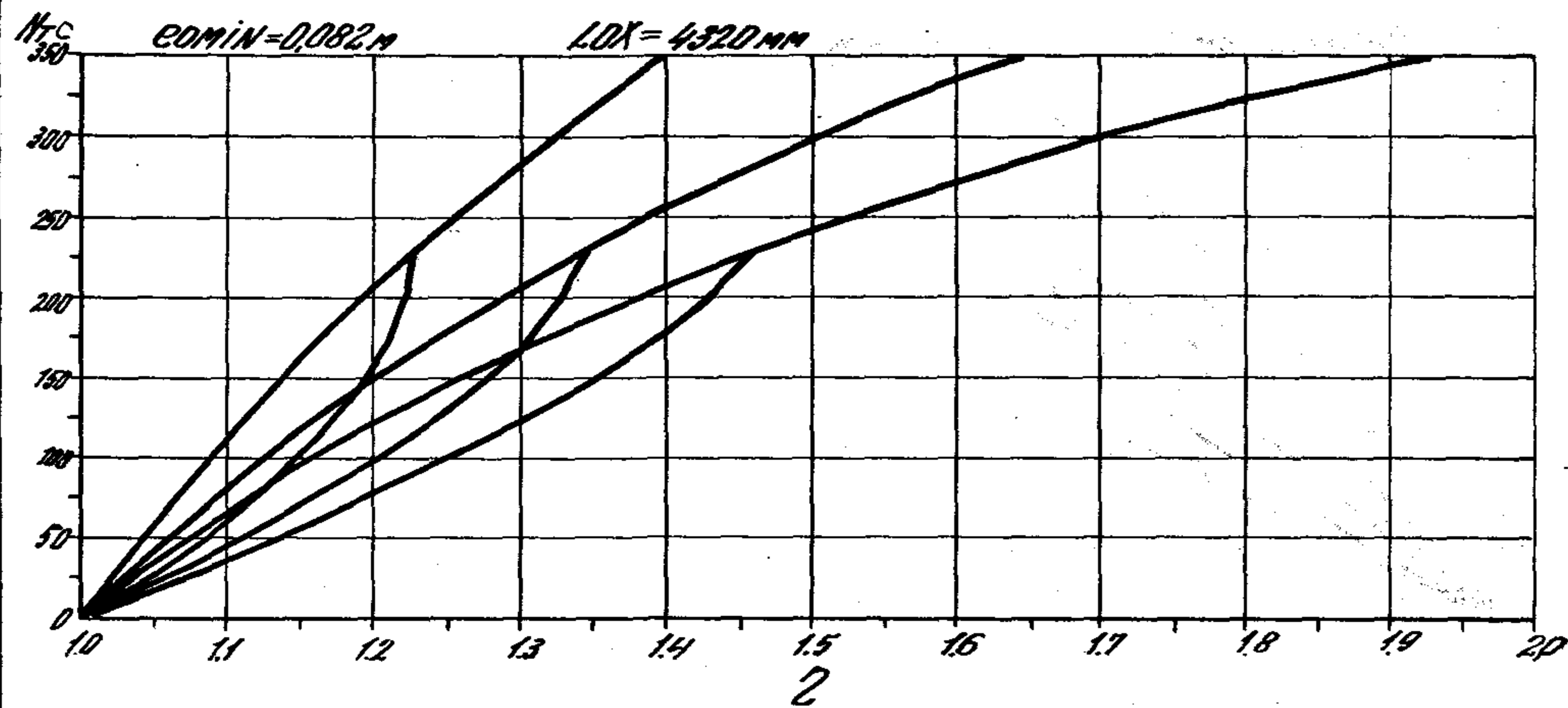

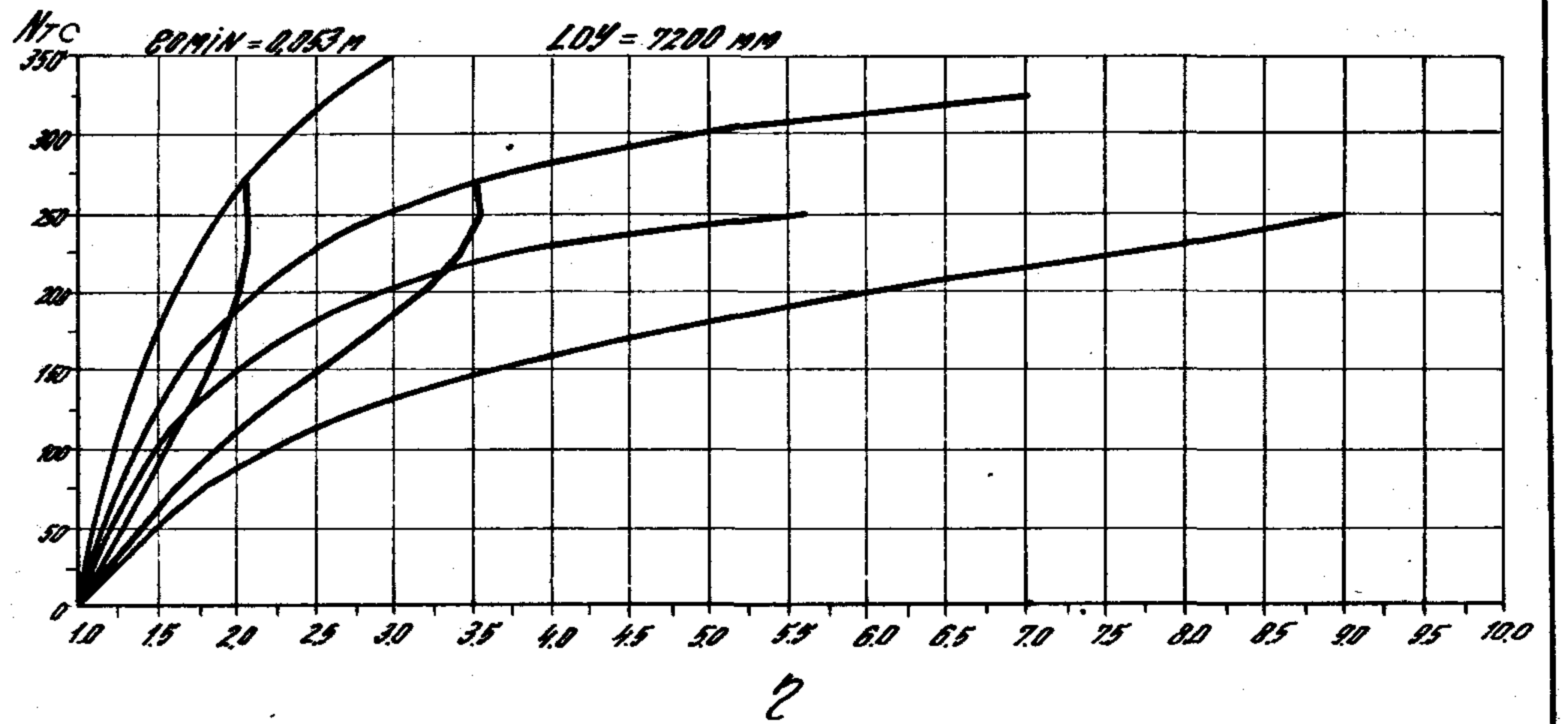
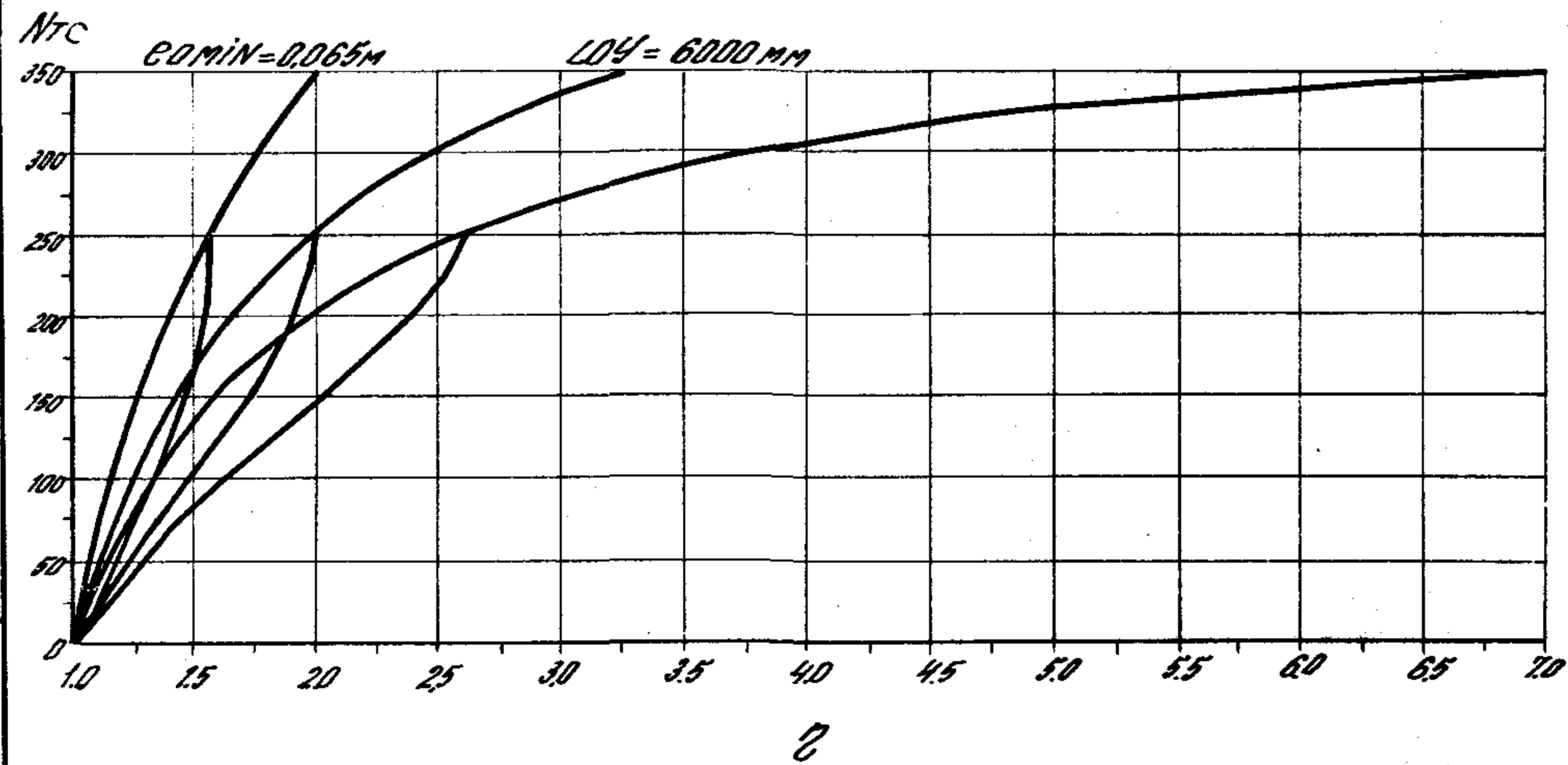
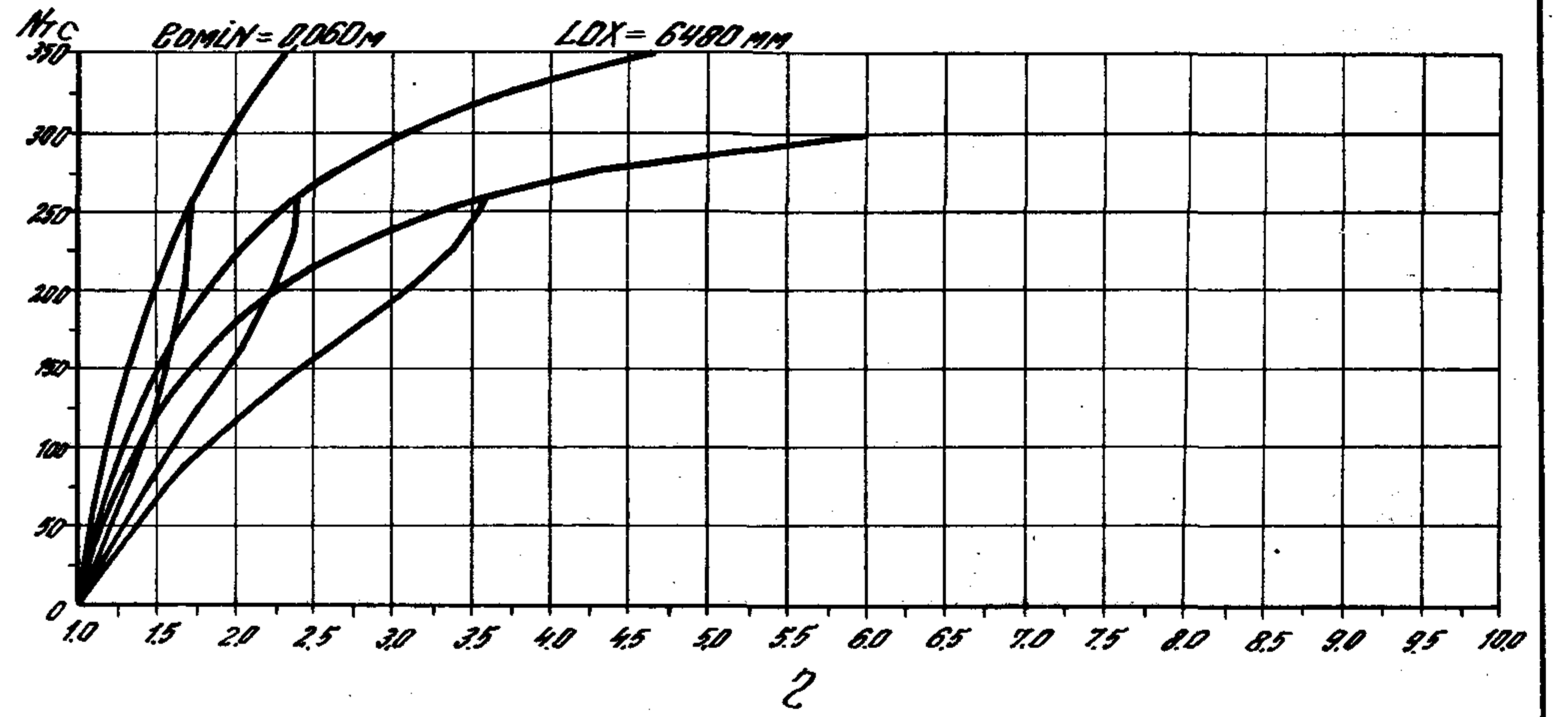
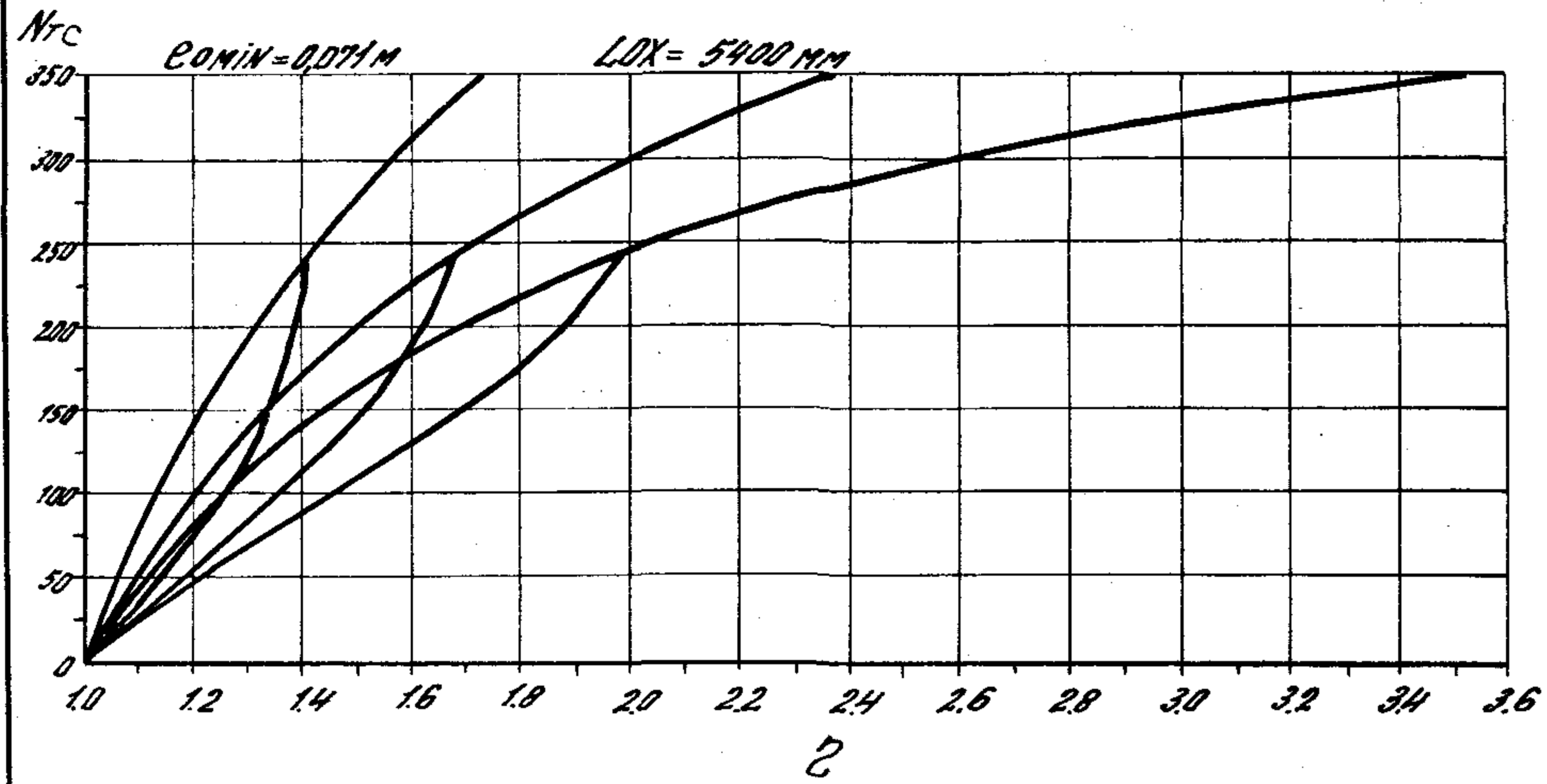

Инв. и подл. Подпись и дата
 Взам. инв. и

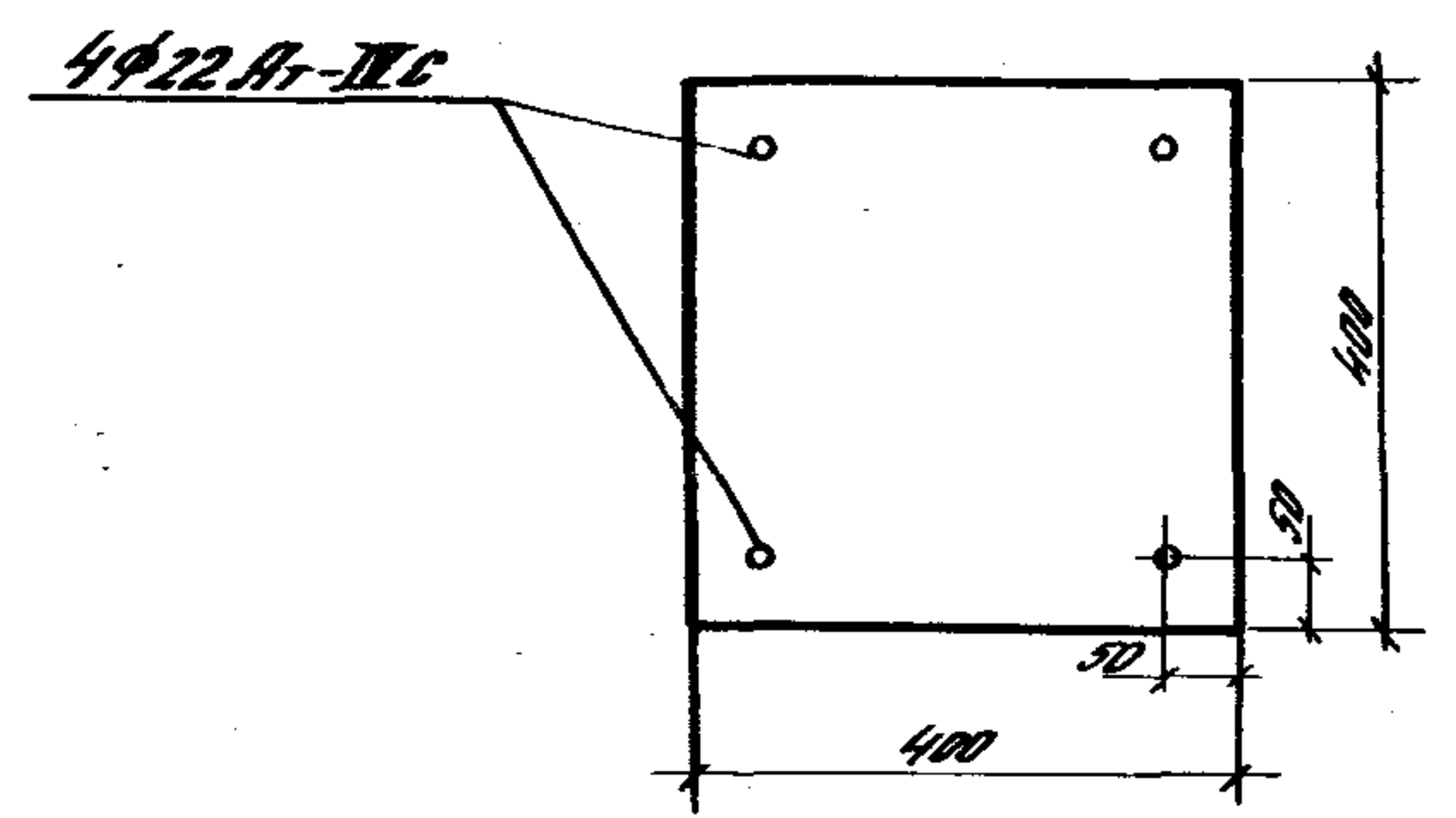
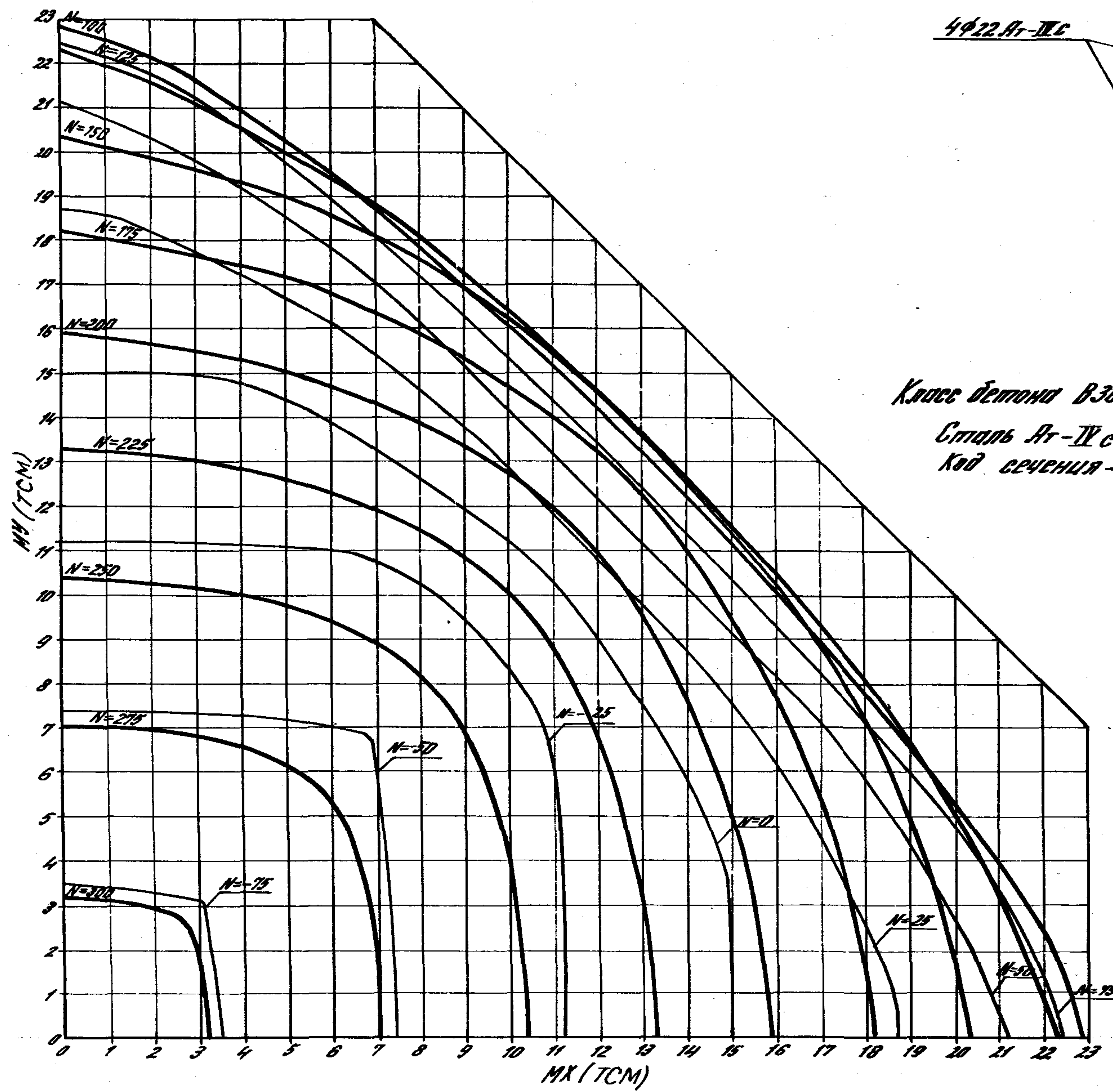

Класс бетона В30.0 ($R_b = 15 \text{ МПа}$ при учете $\gamma_{b2} = 0.90$)
 Сталь А-IIc
 Код сечения - 111Б

Имя и фамилия
 Подпись и дата
 Взам. инв. №

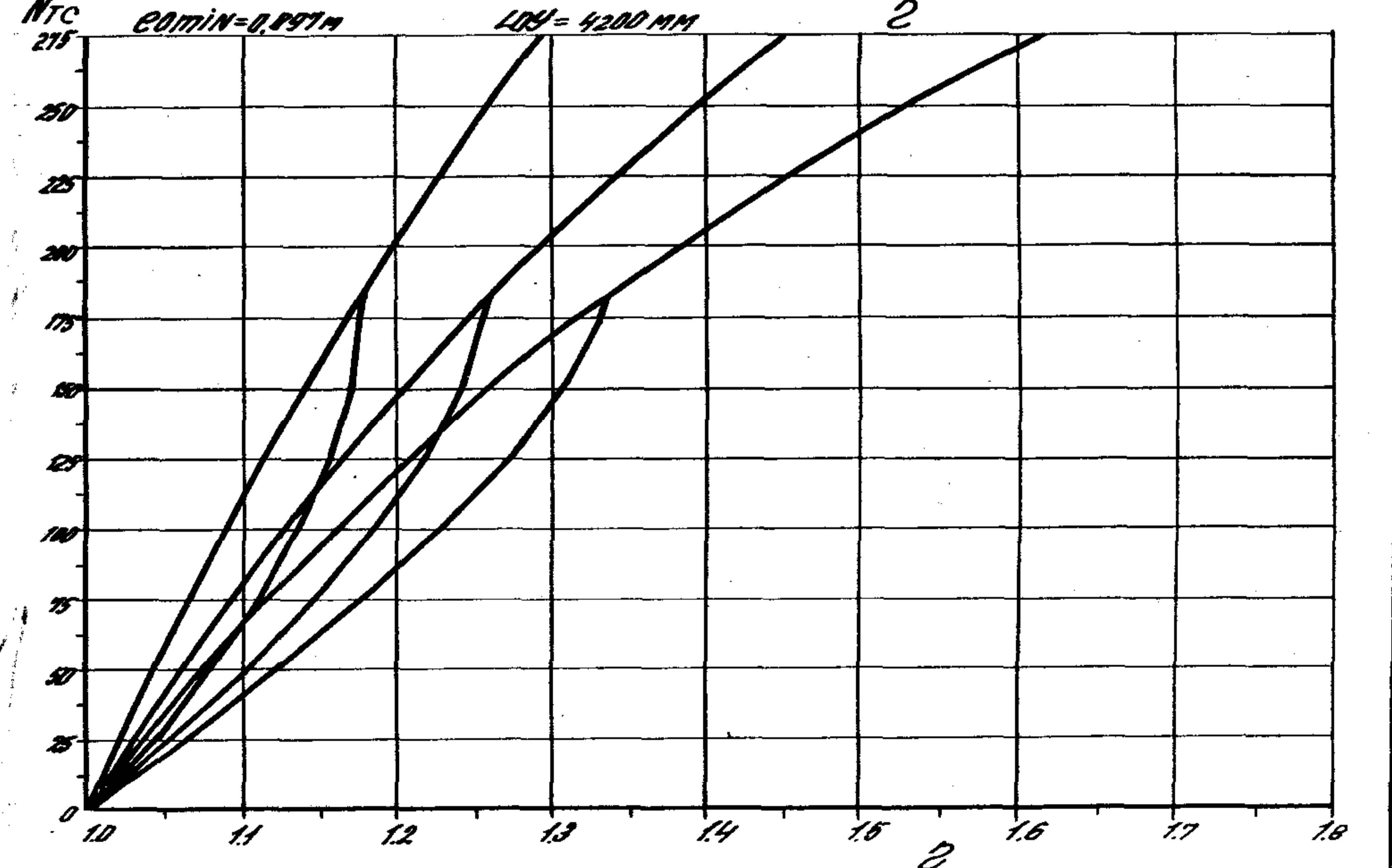
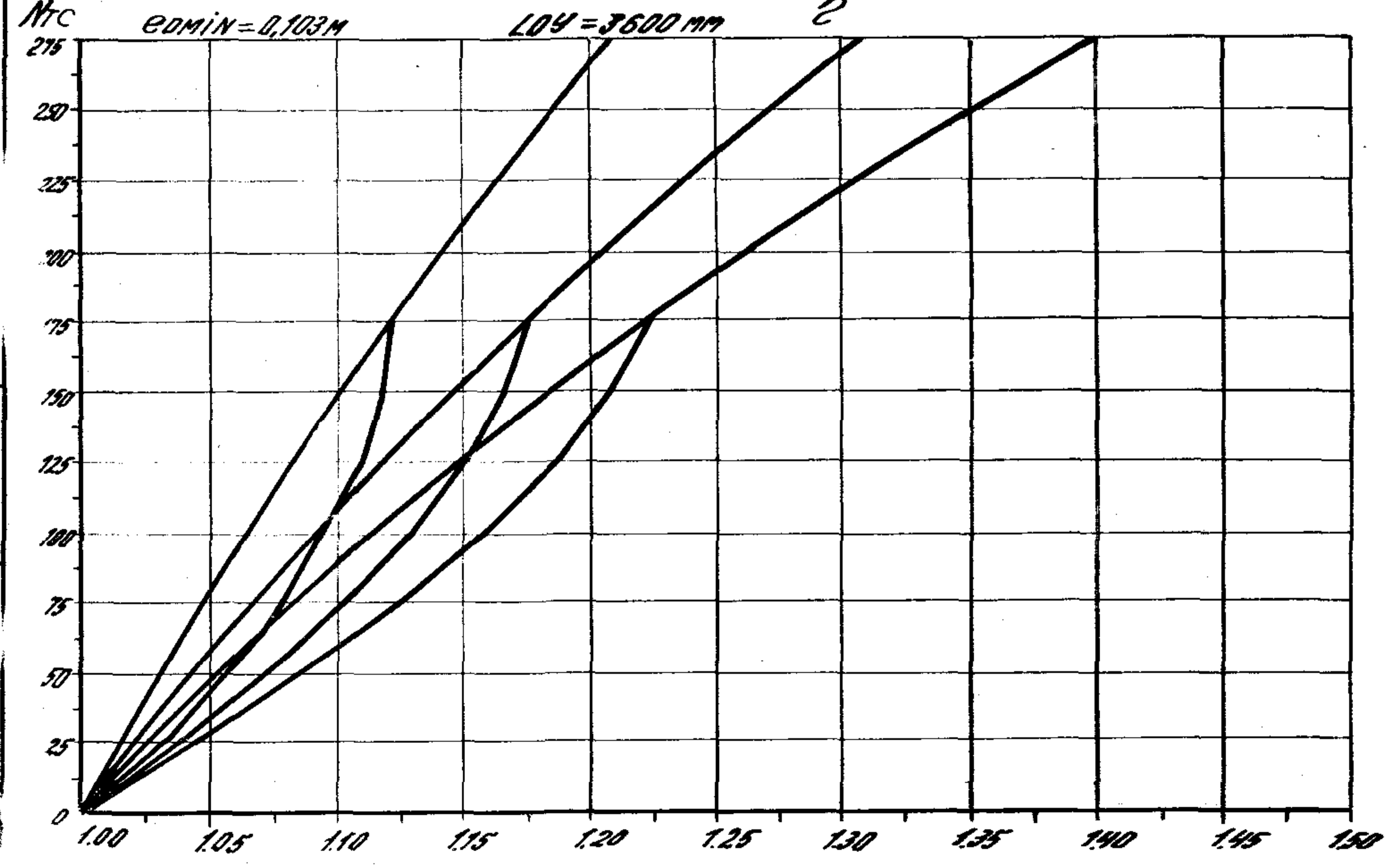
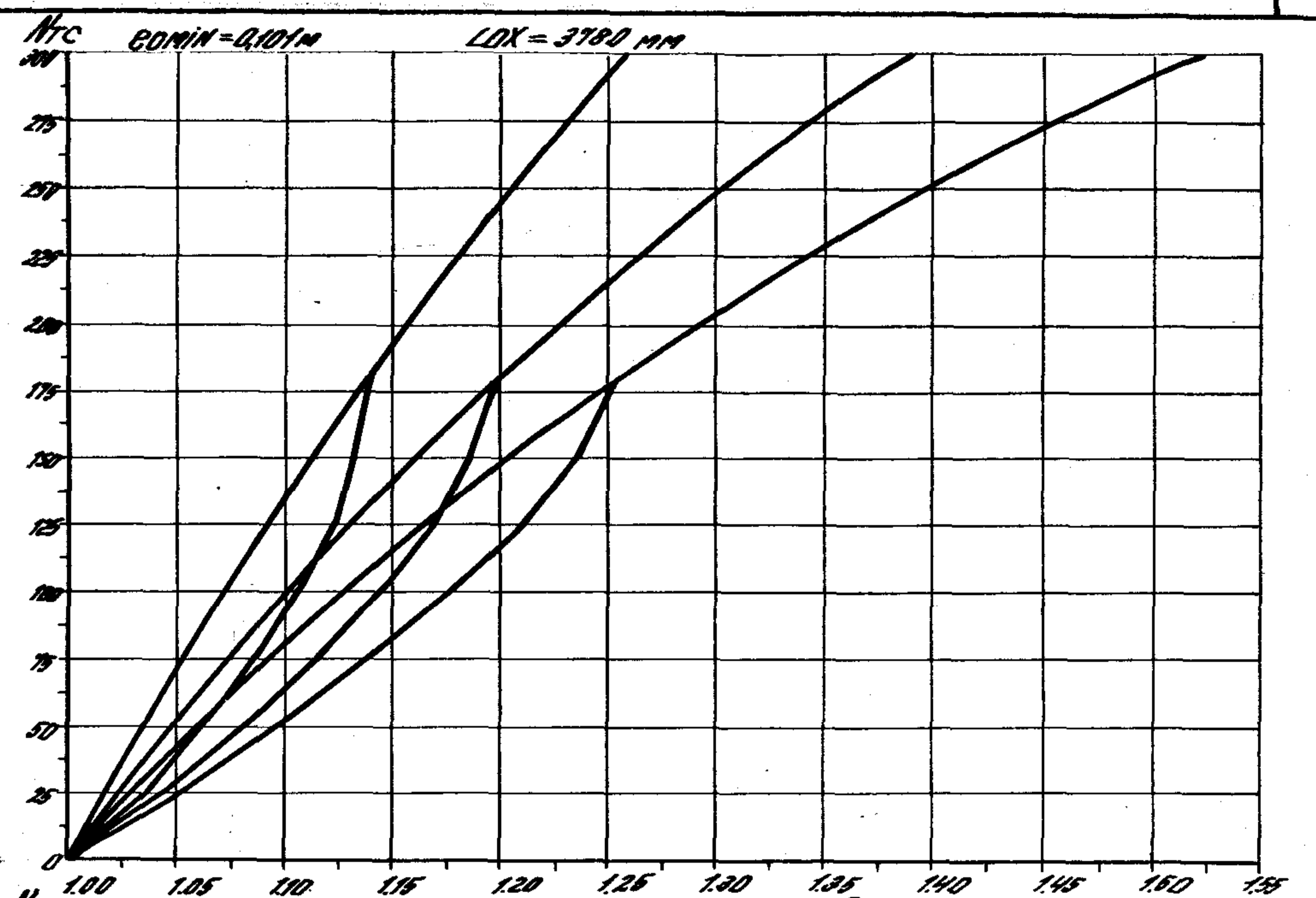
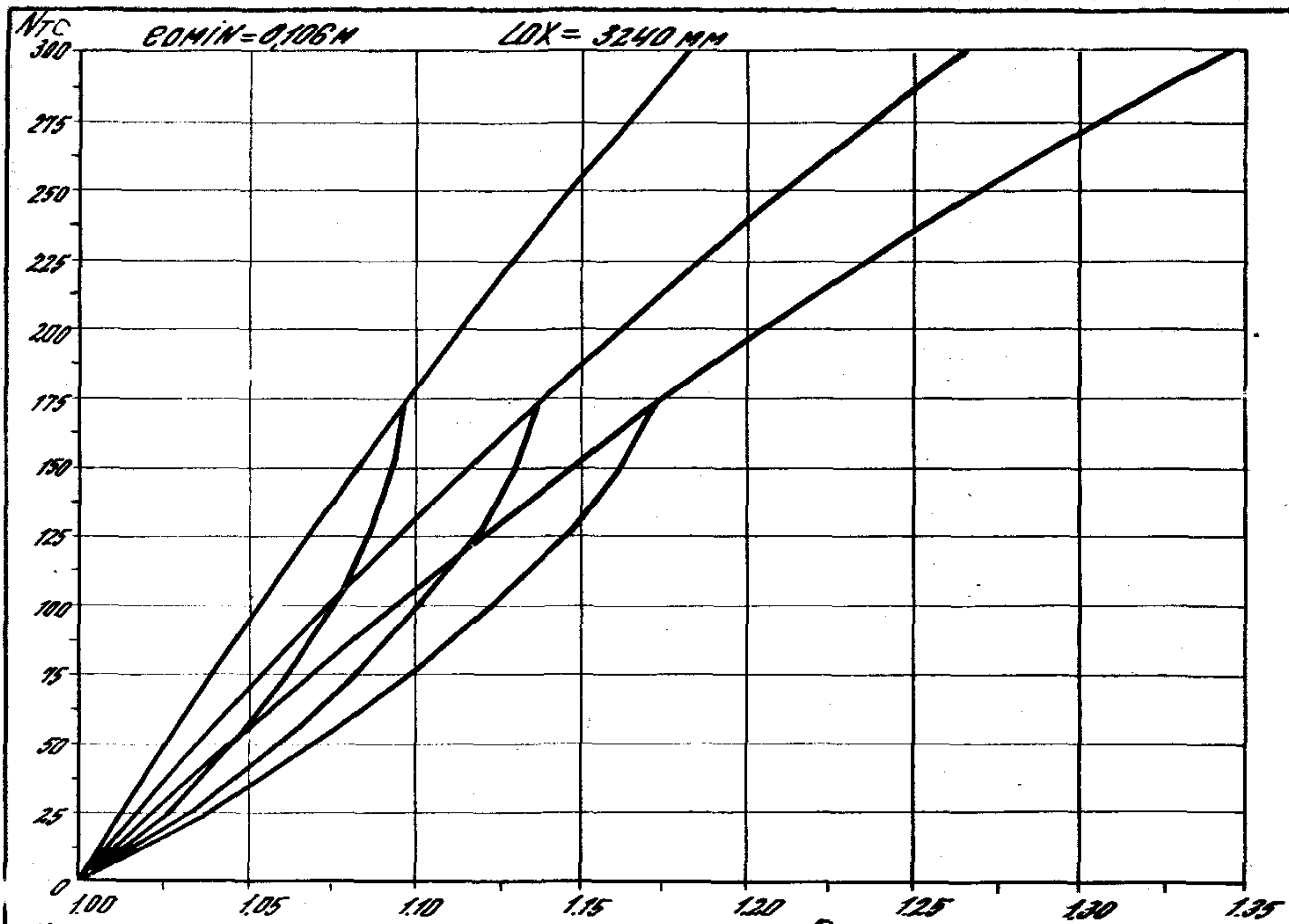

1. 020. 1-4 0-9-002 Лист 86

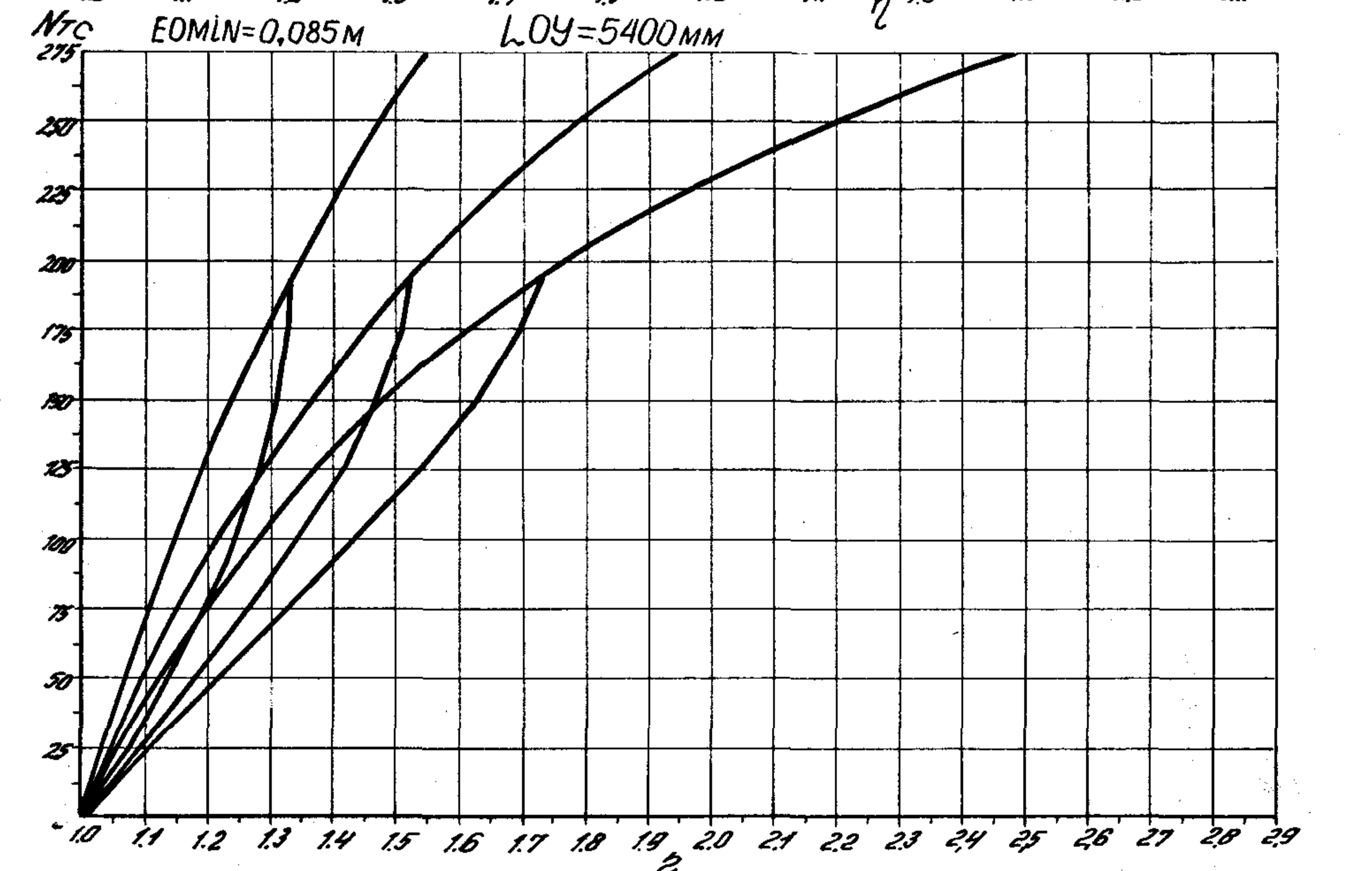
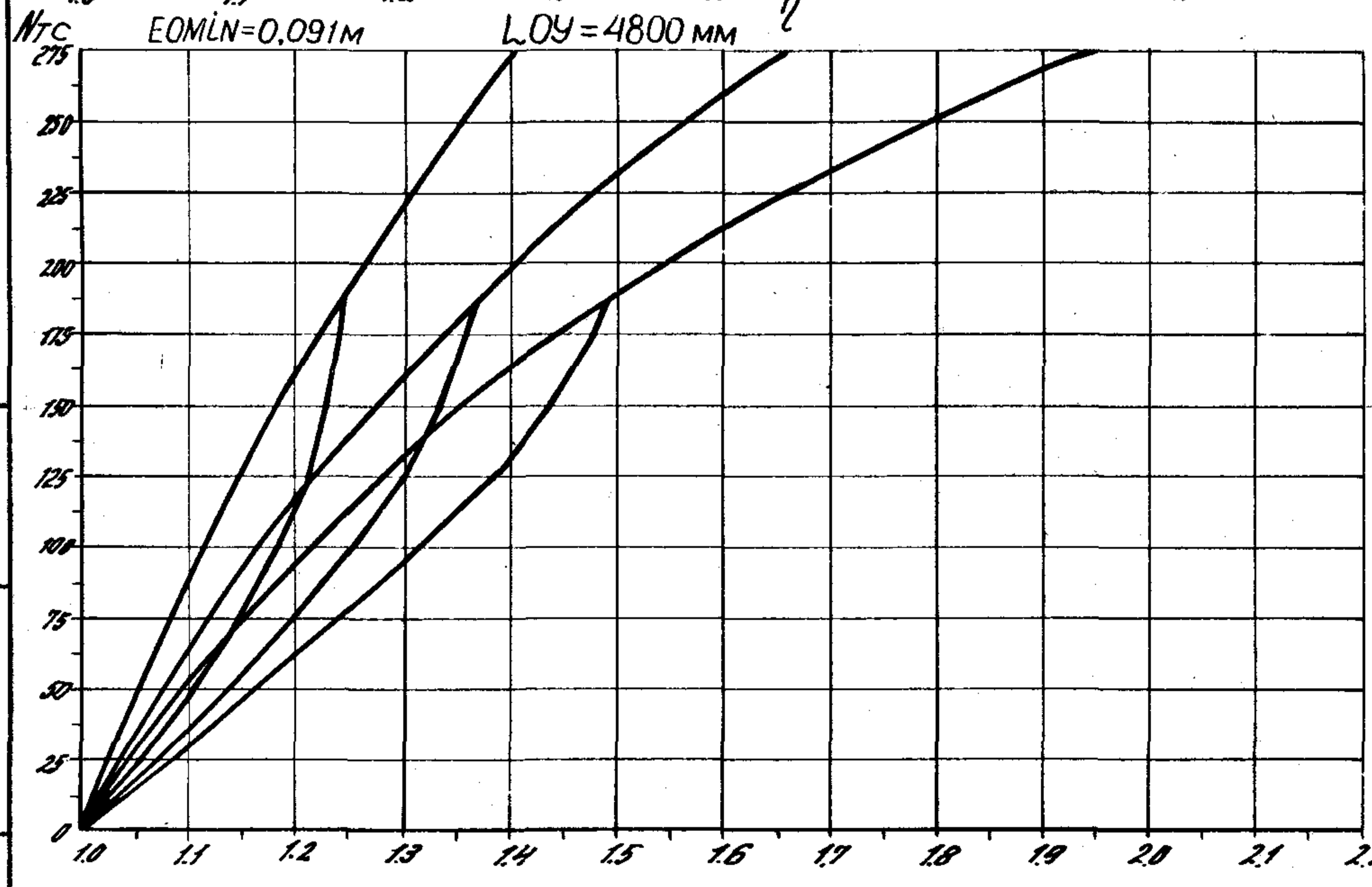
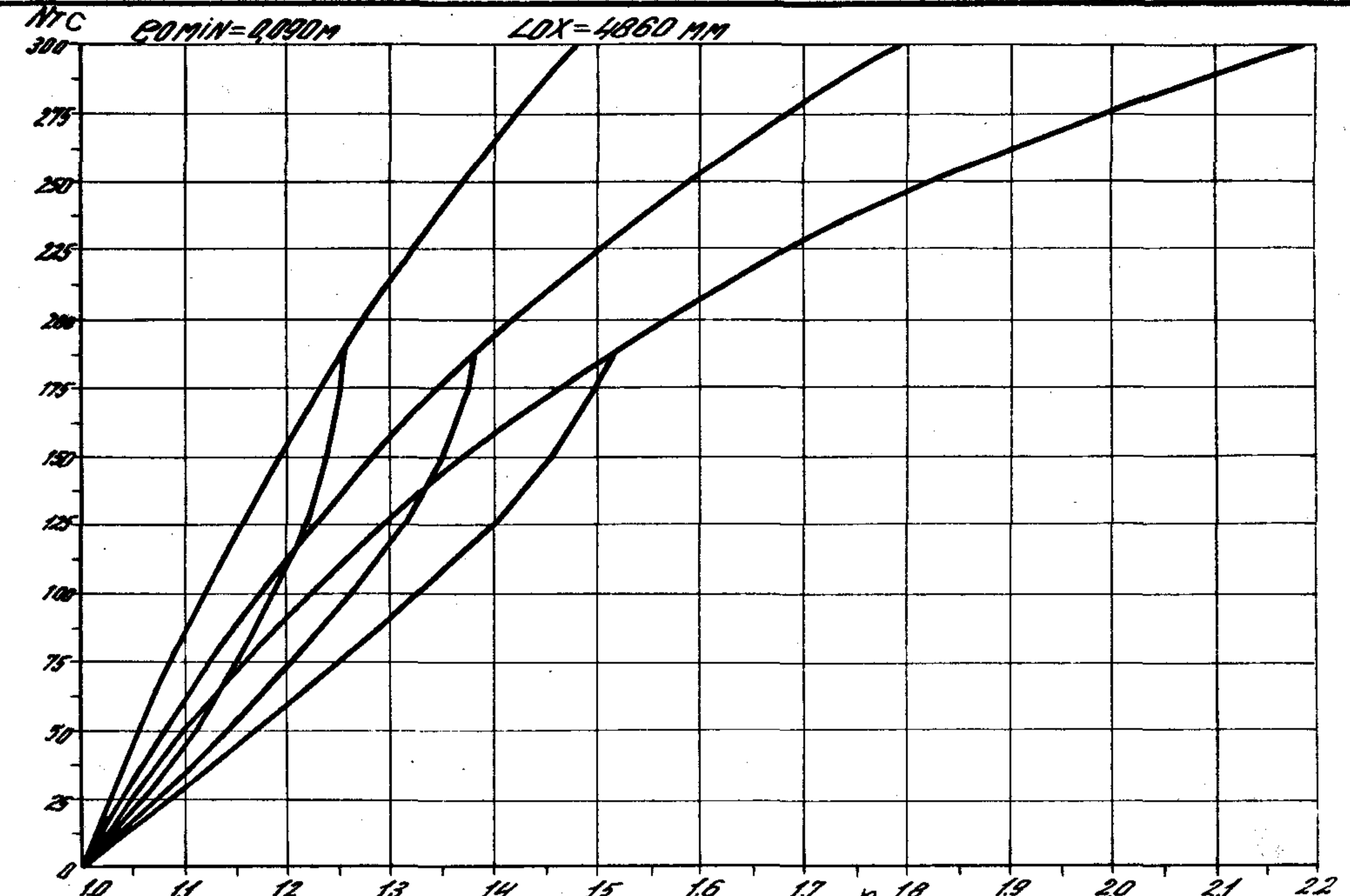
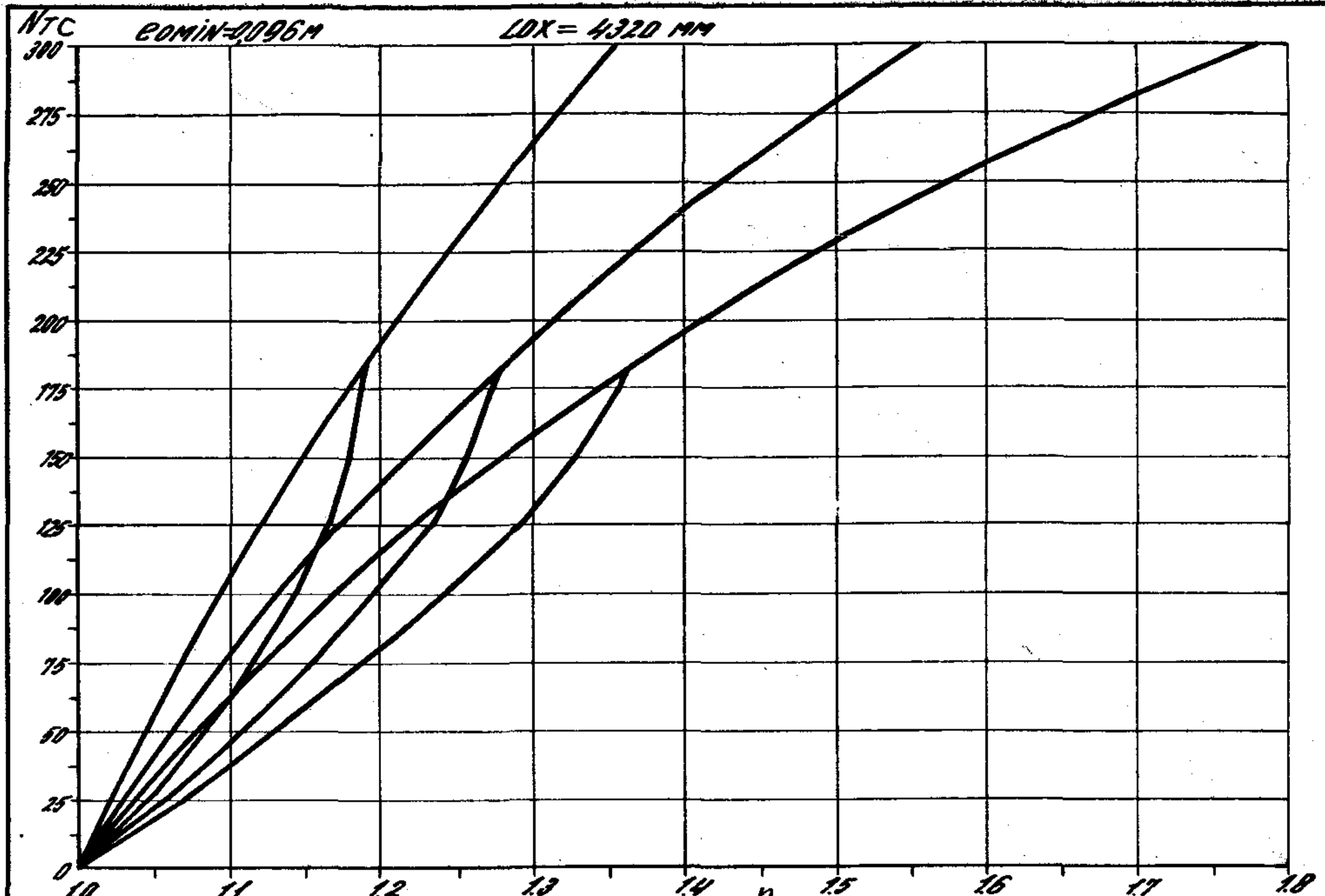

МАТ. И РАСЧ. ПОДРОБНОГО ПРОЕКТА

2

1.020.1-4 0-9 002

Лист	87
------	----

СОЛ. 10. 2010

2010-01-10

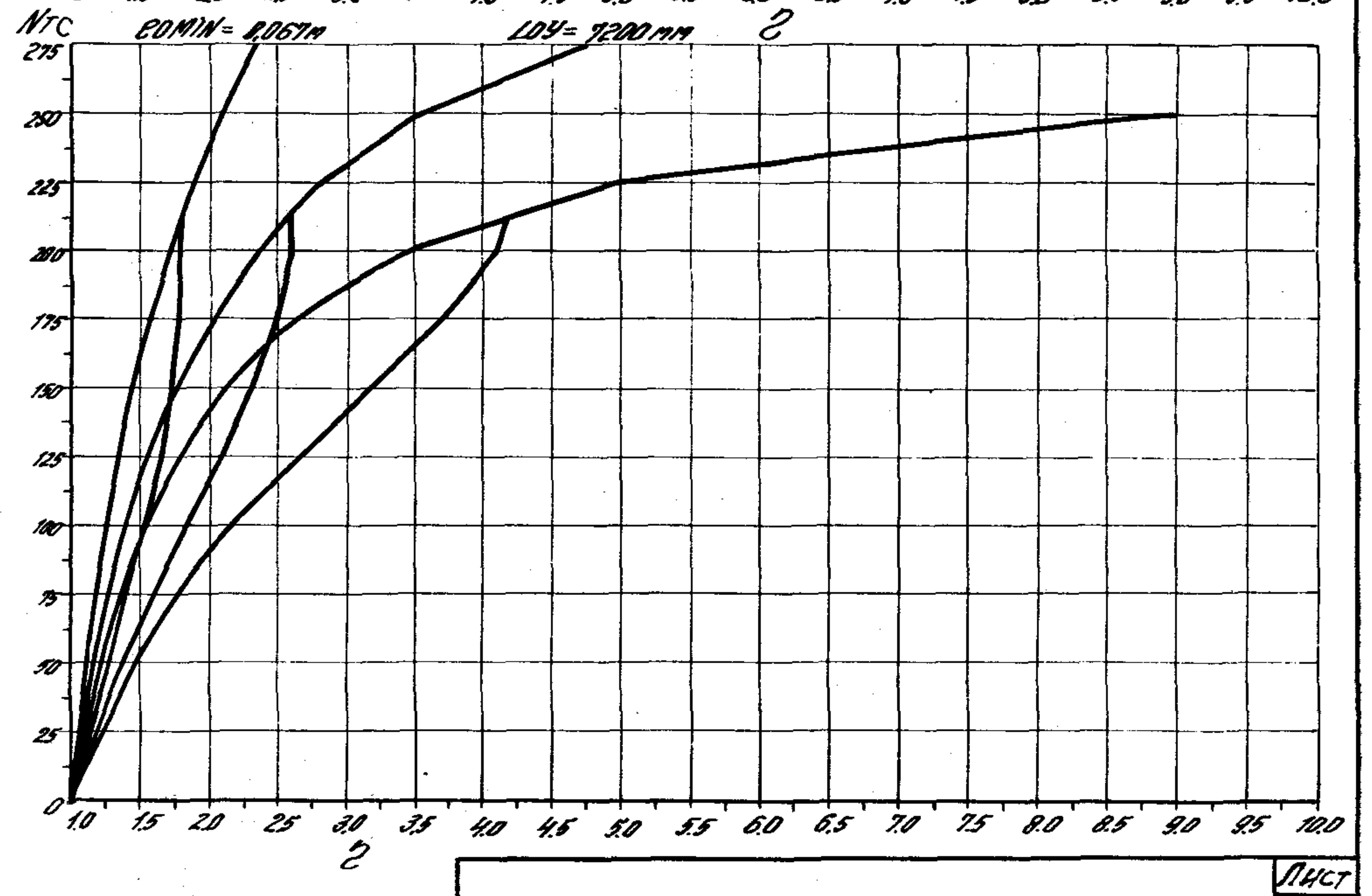
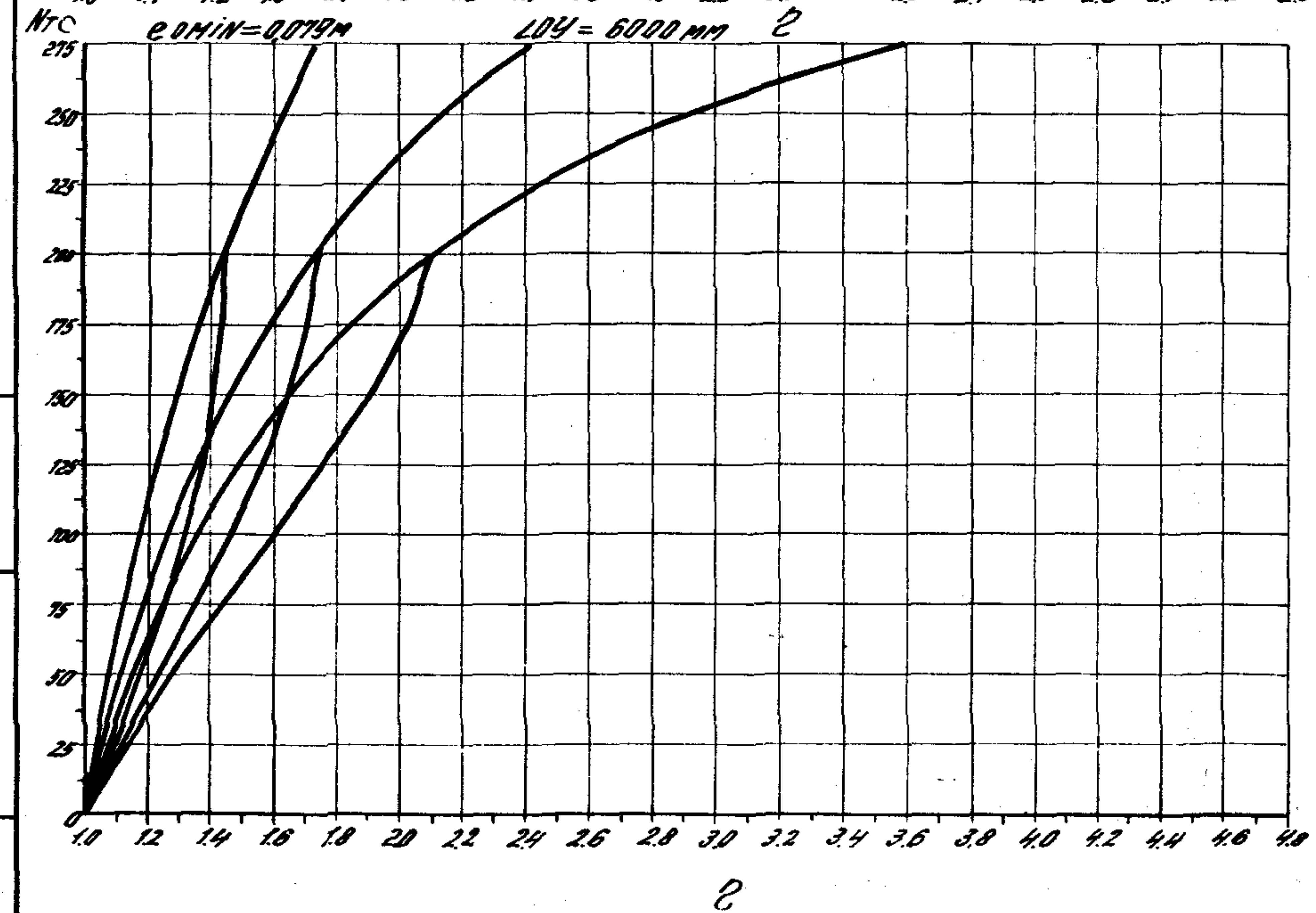
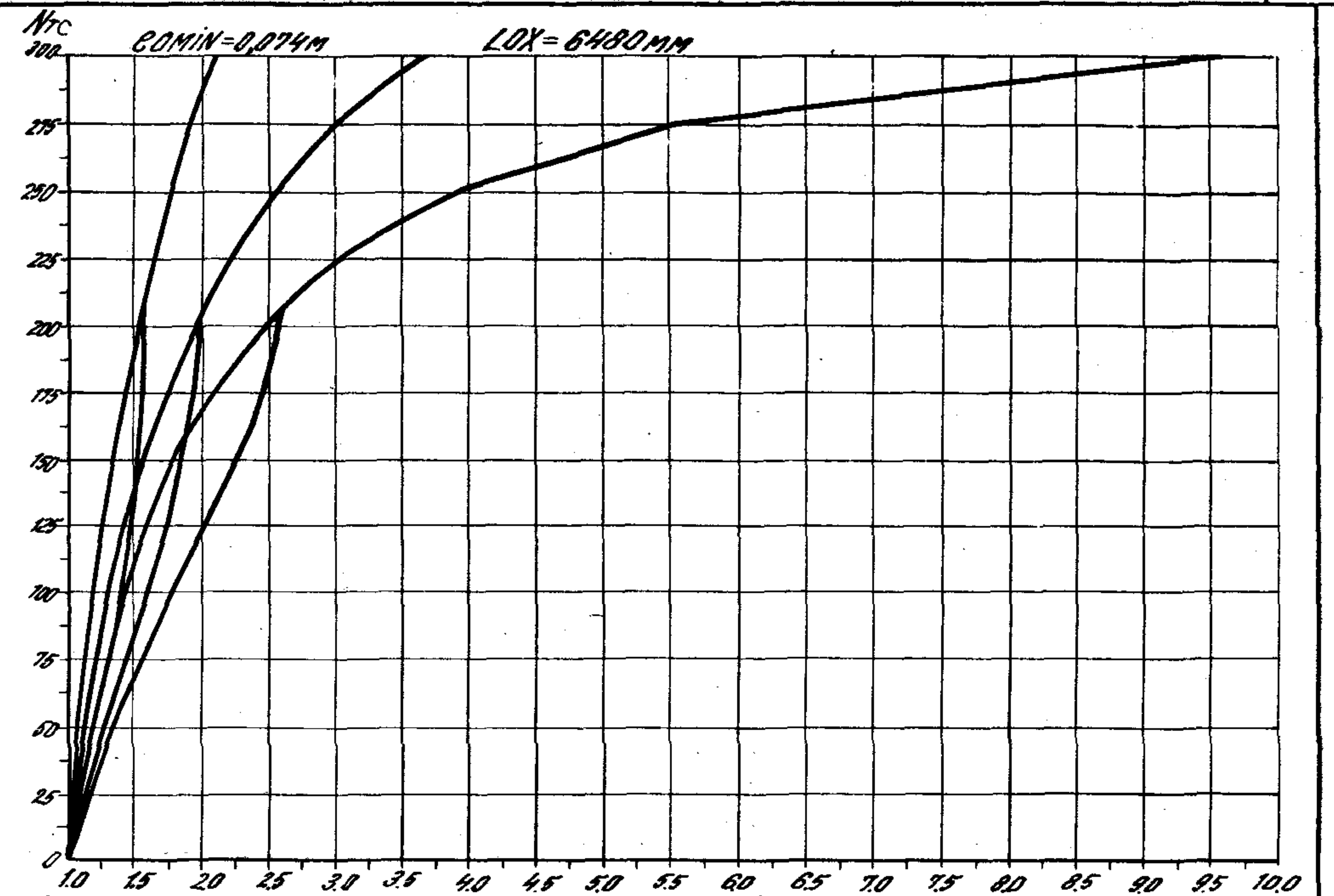
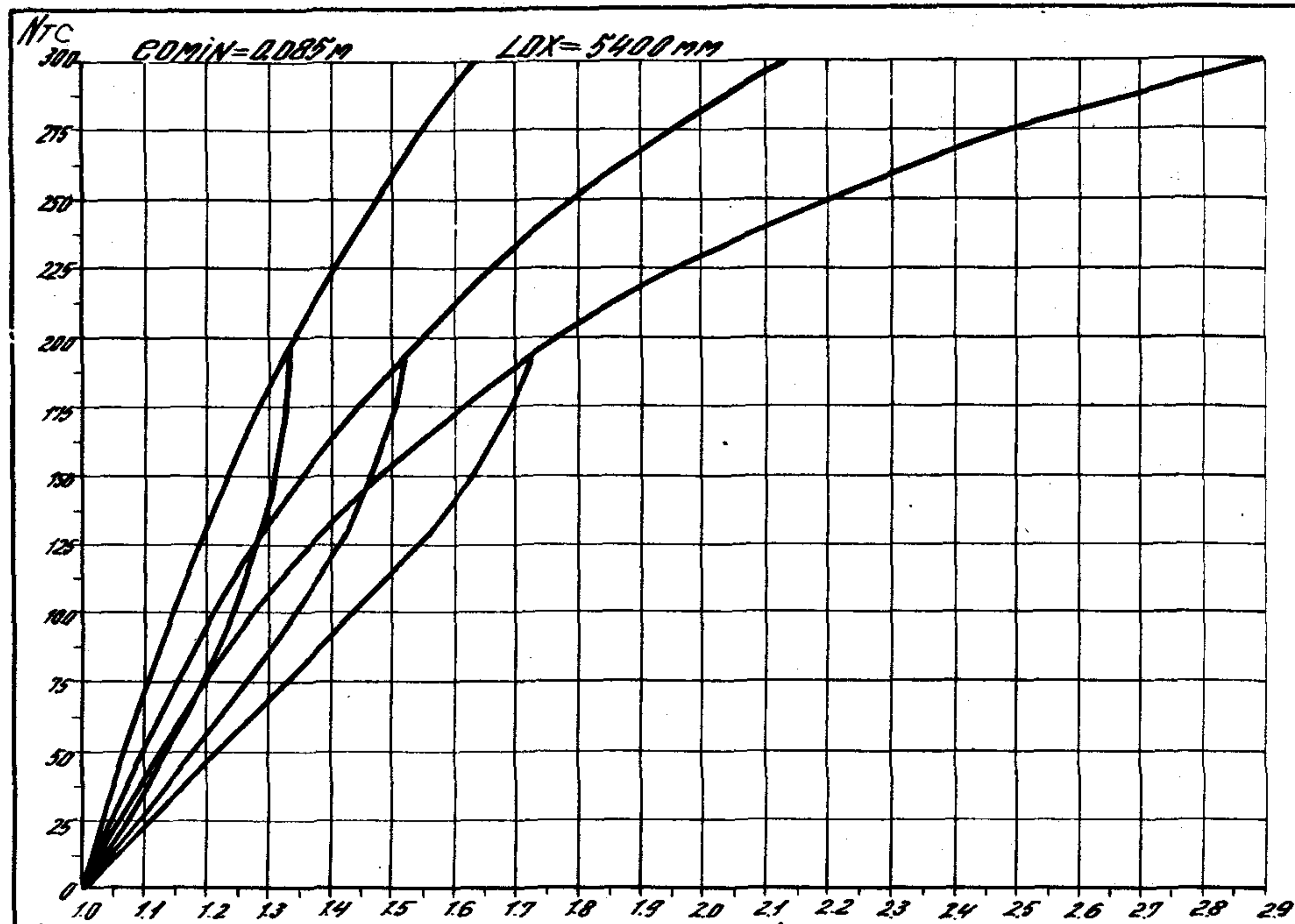

1.020.1-4
 0-9 002
 88

1.020.1-4 0-9 002 88

2011-01-10

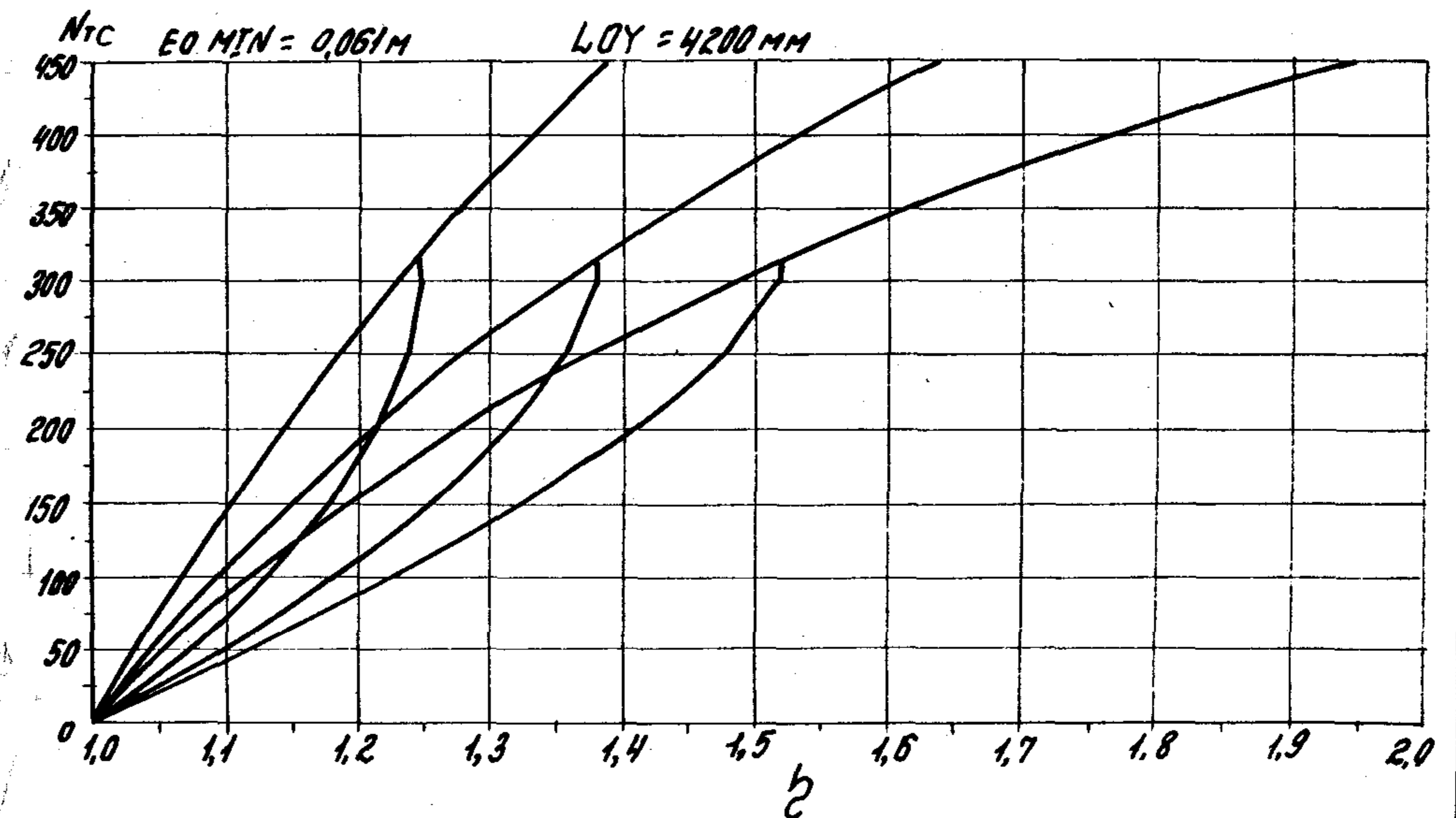
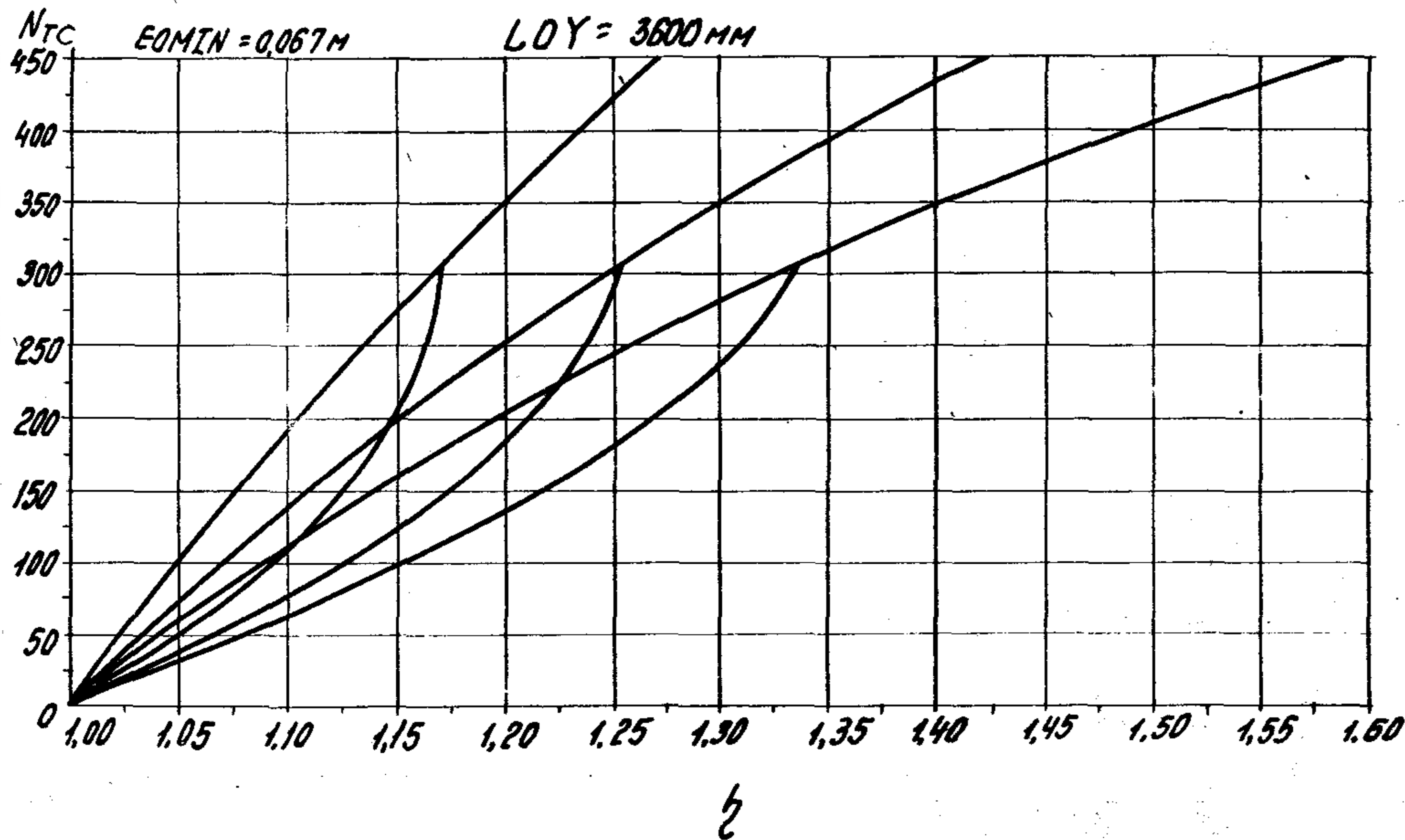
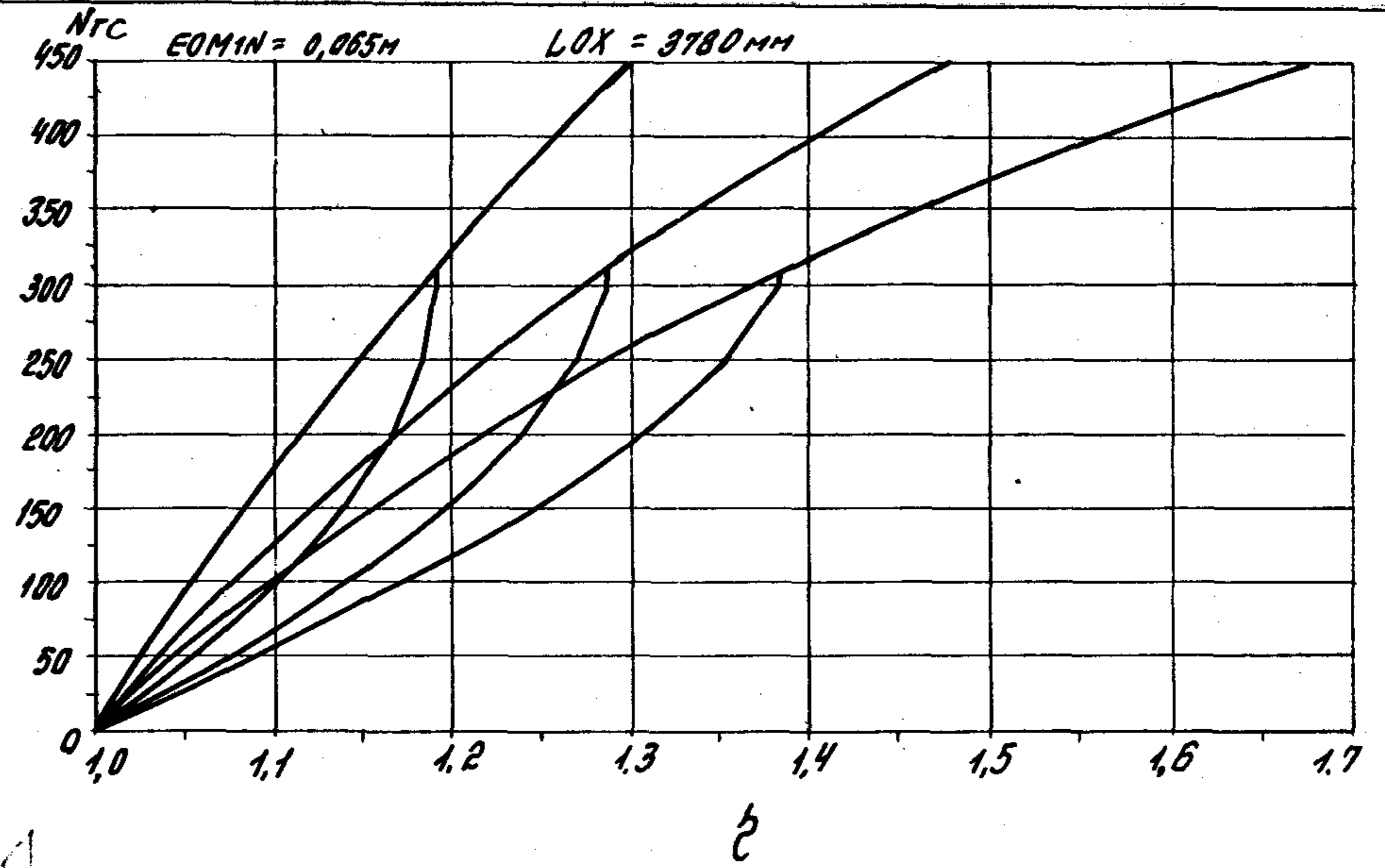
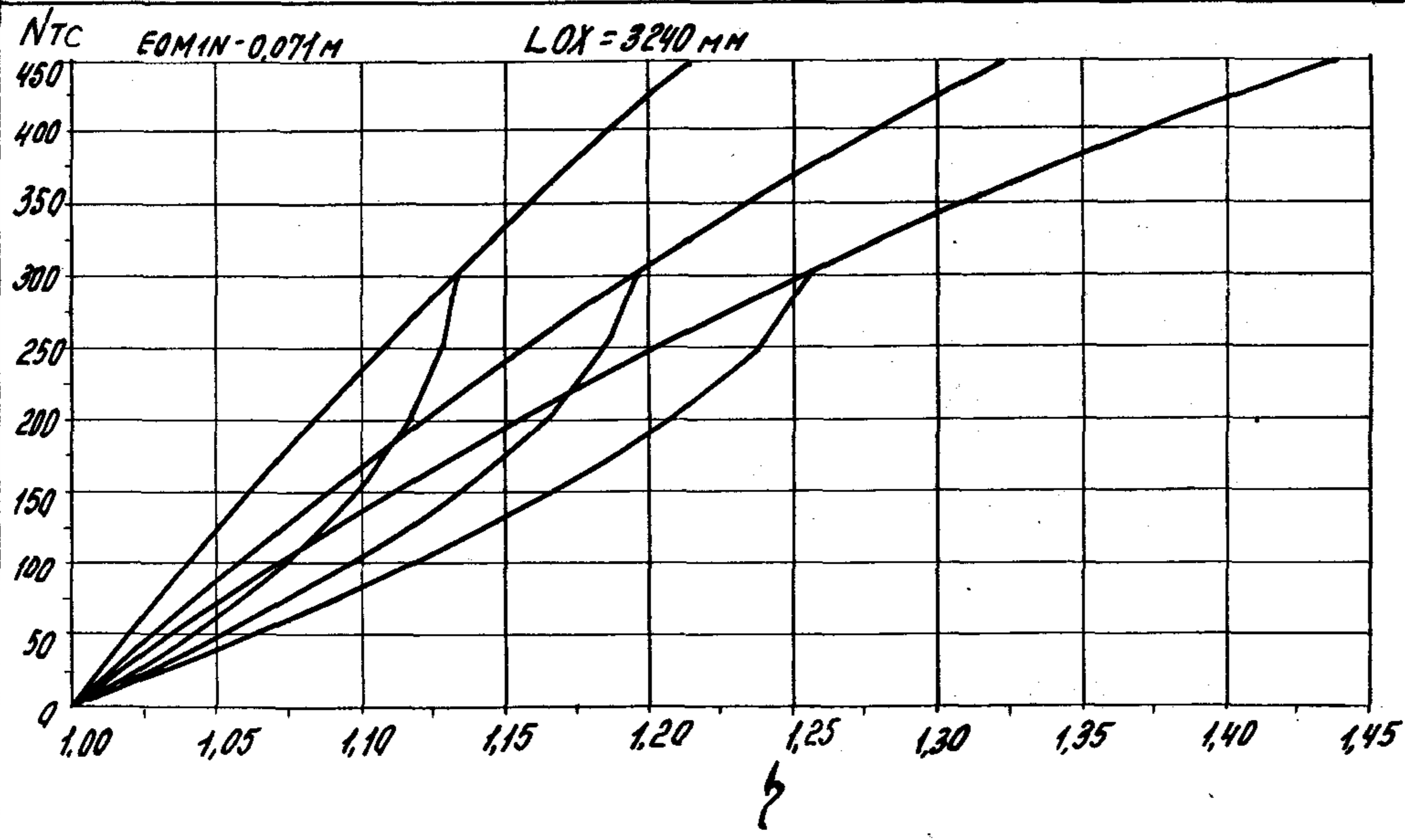

Л. И. ИВАНОВ

1.020.1-4 0-9 002 90

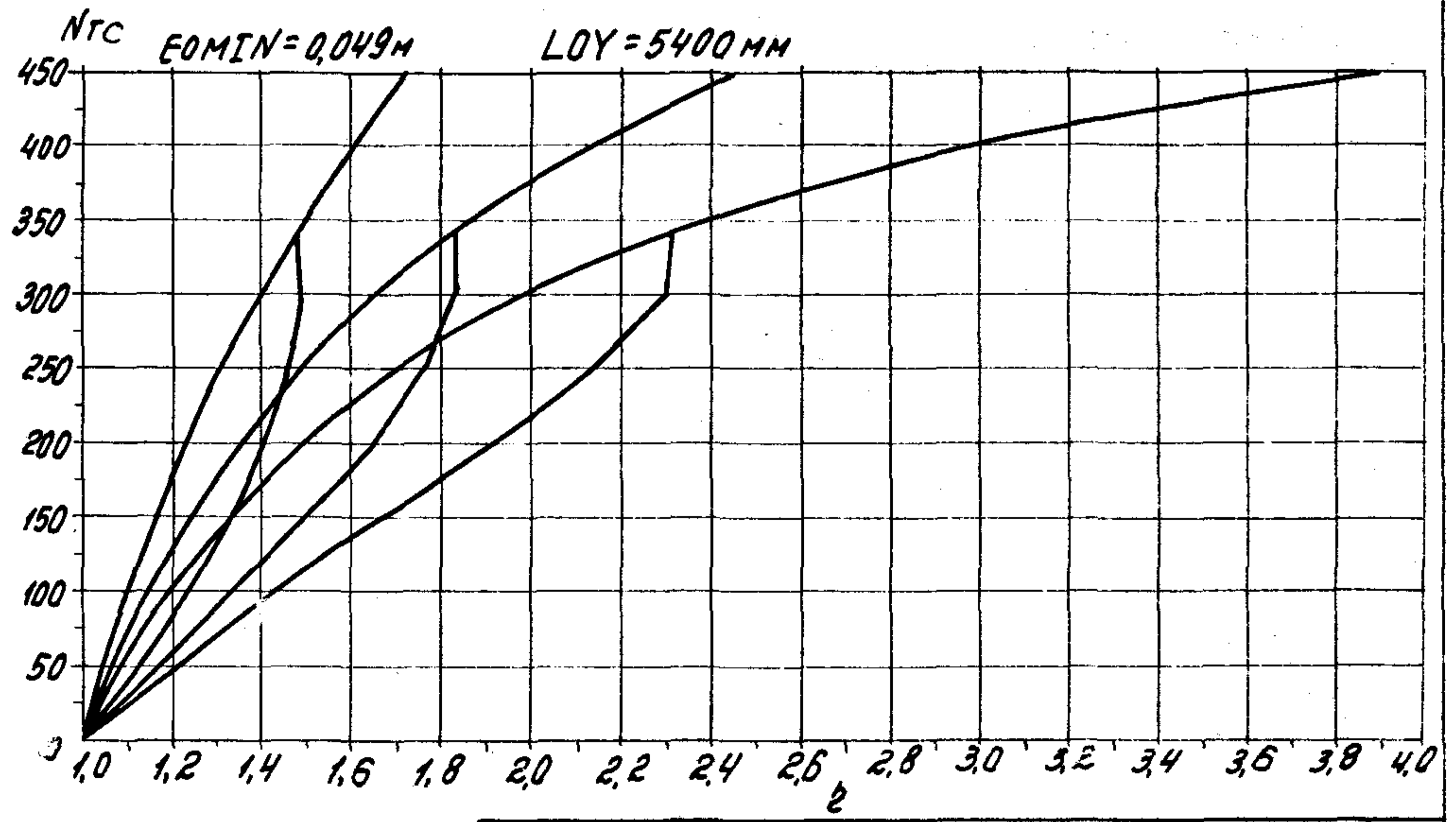
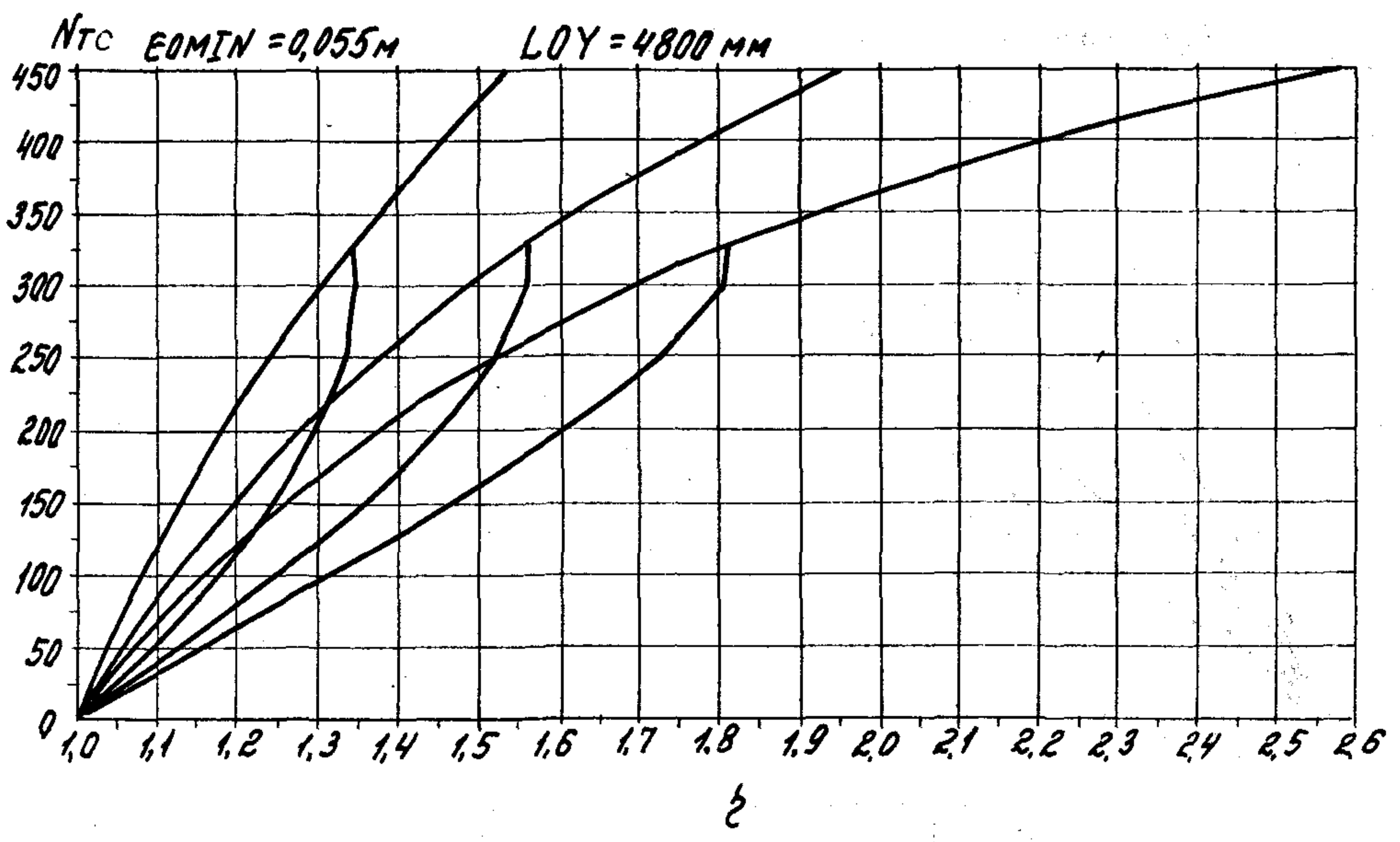
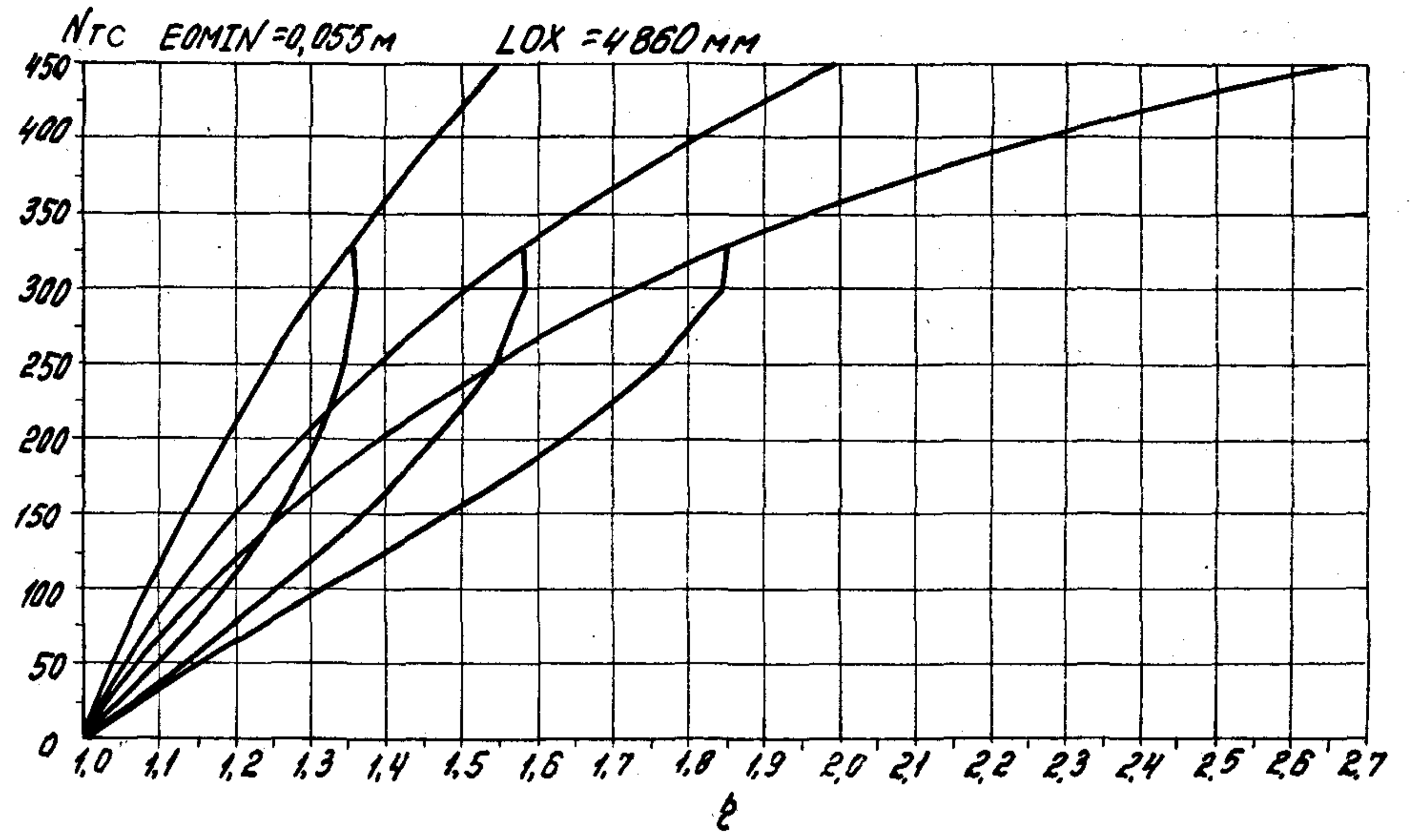
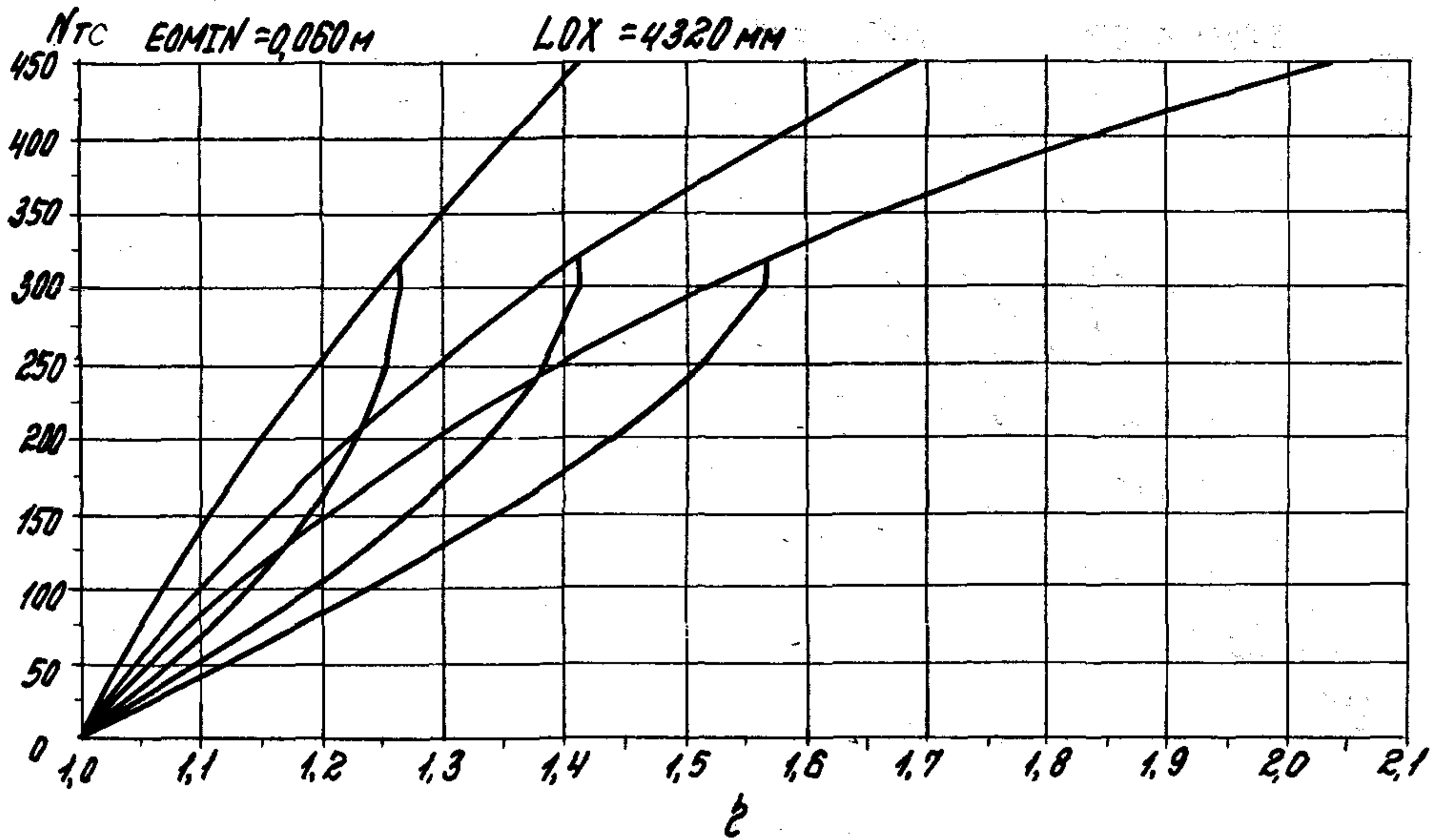

1.020.1-4 0-9.002 91

LINES 1-4

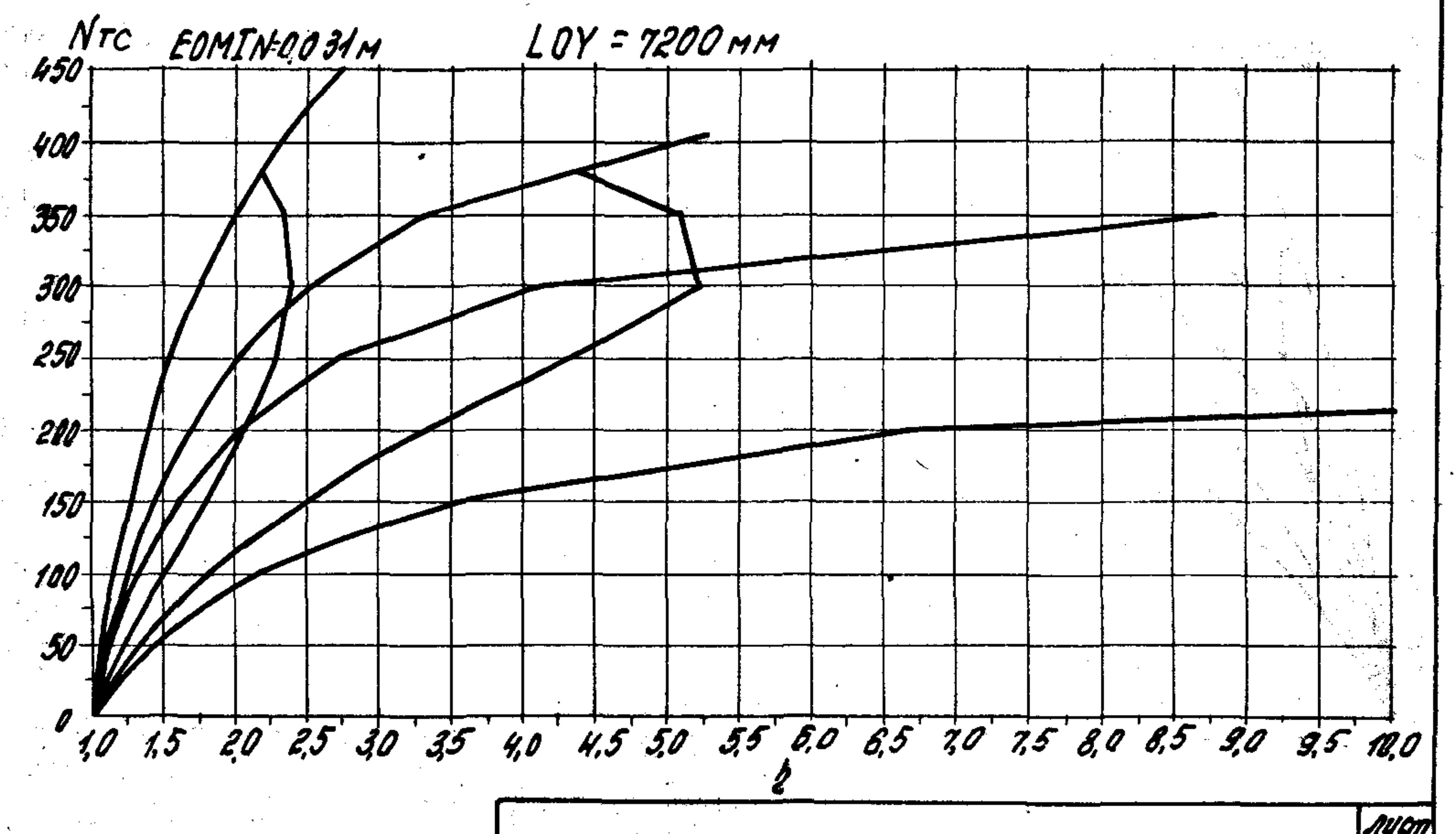
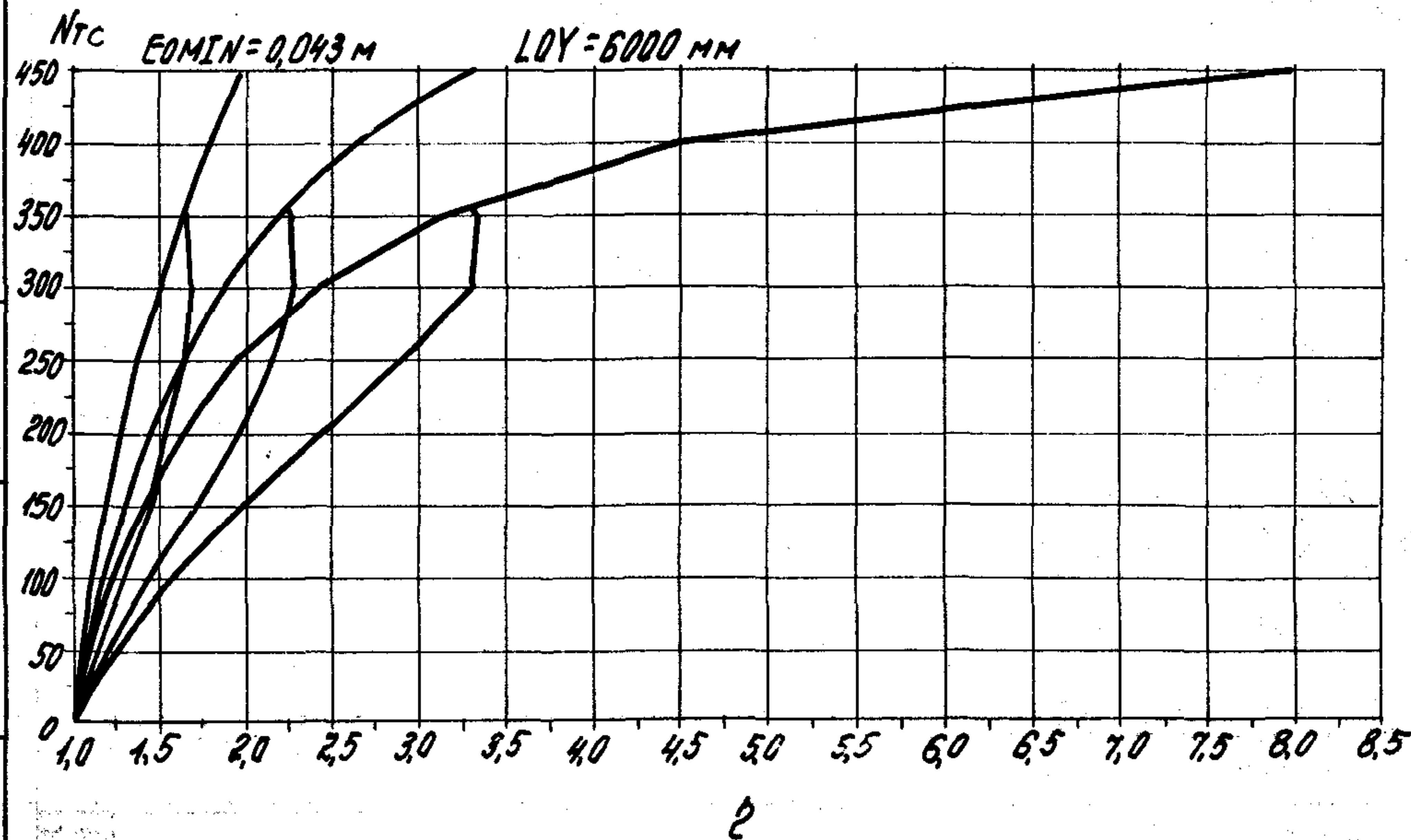
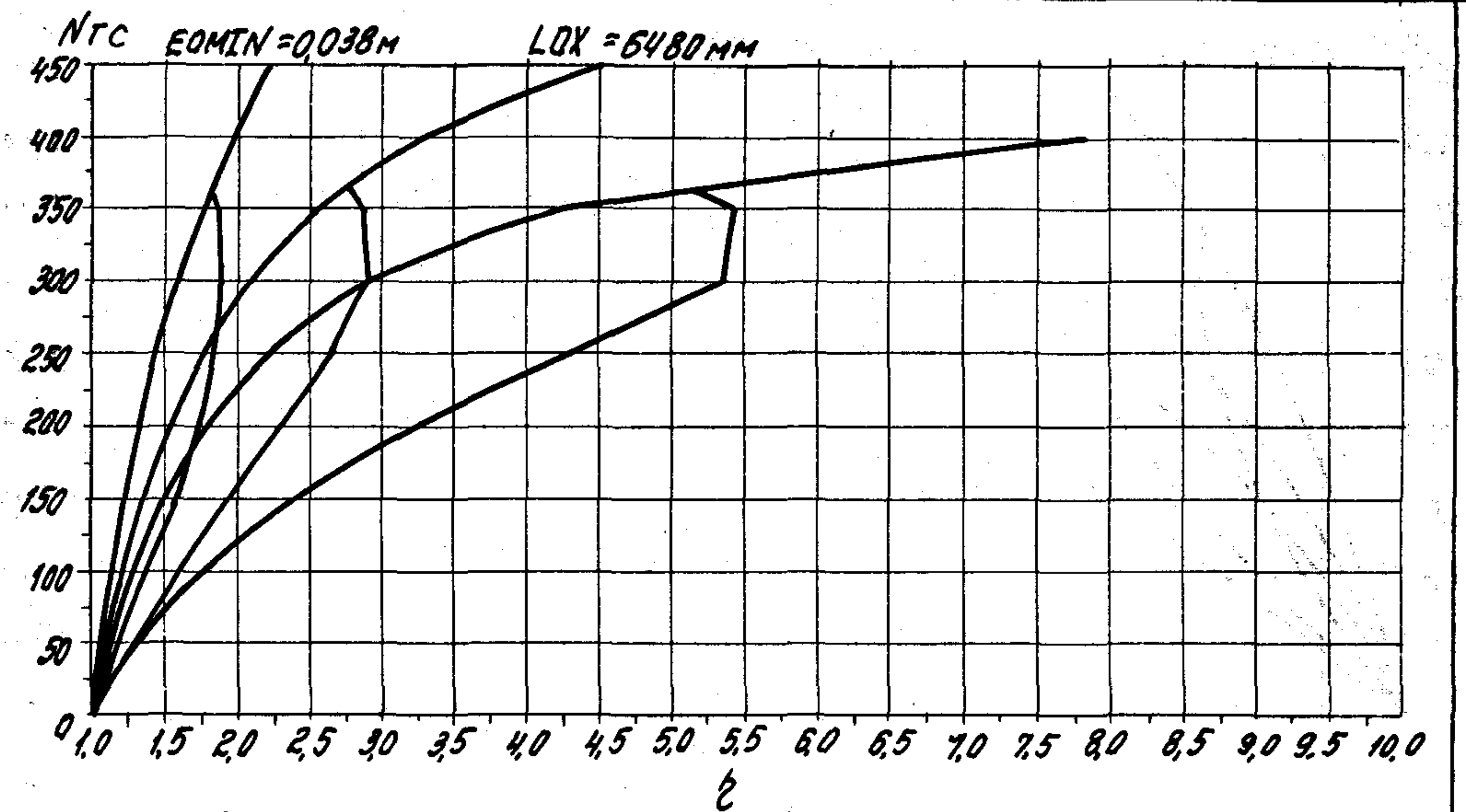
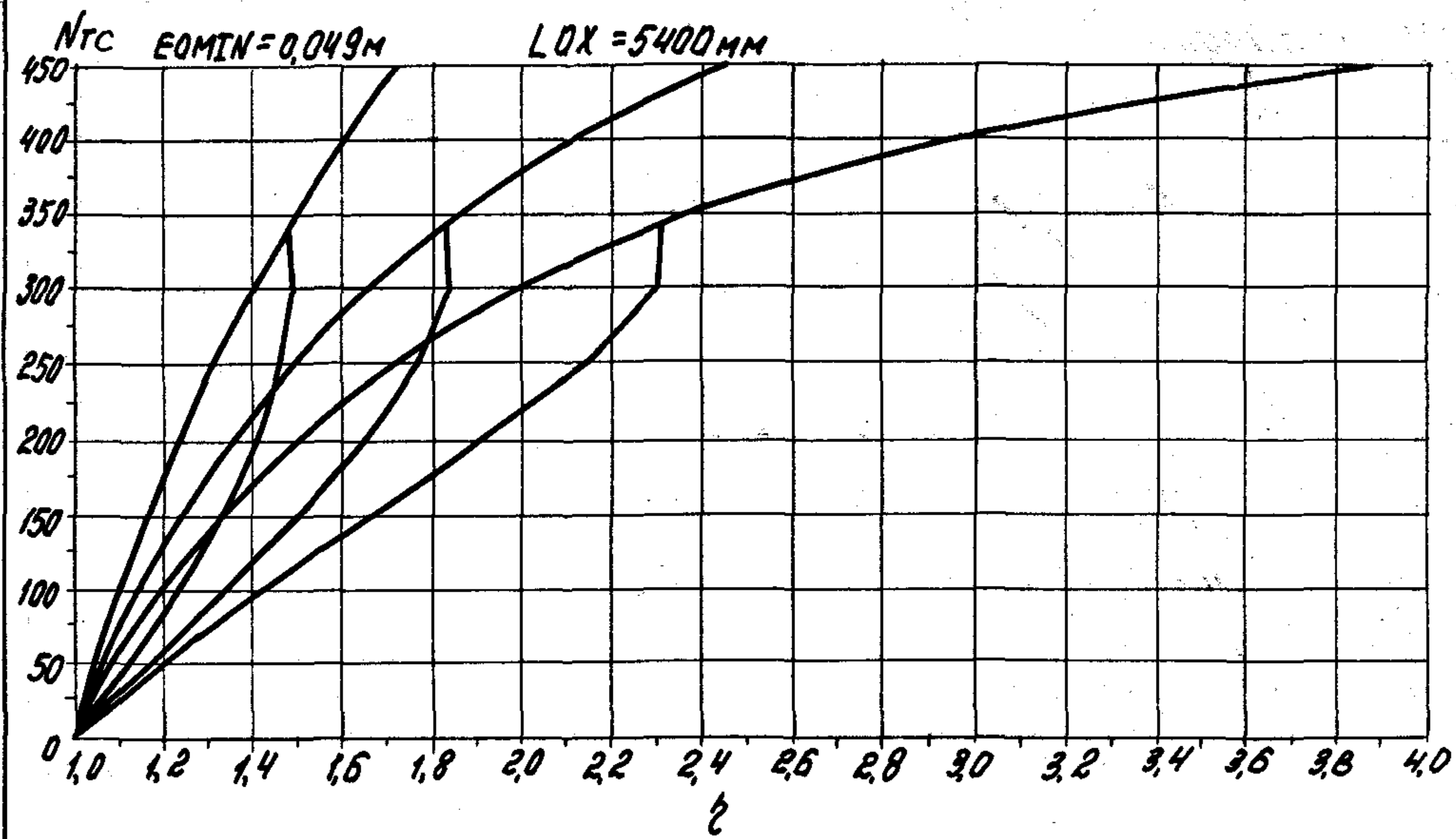

УИД. № 0001. Тодруулба Удгма
 БЗДМ, УИД. №

1.020. 1-4 0-9 002 92

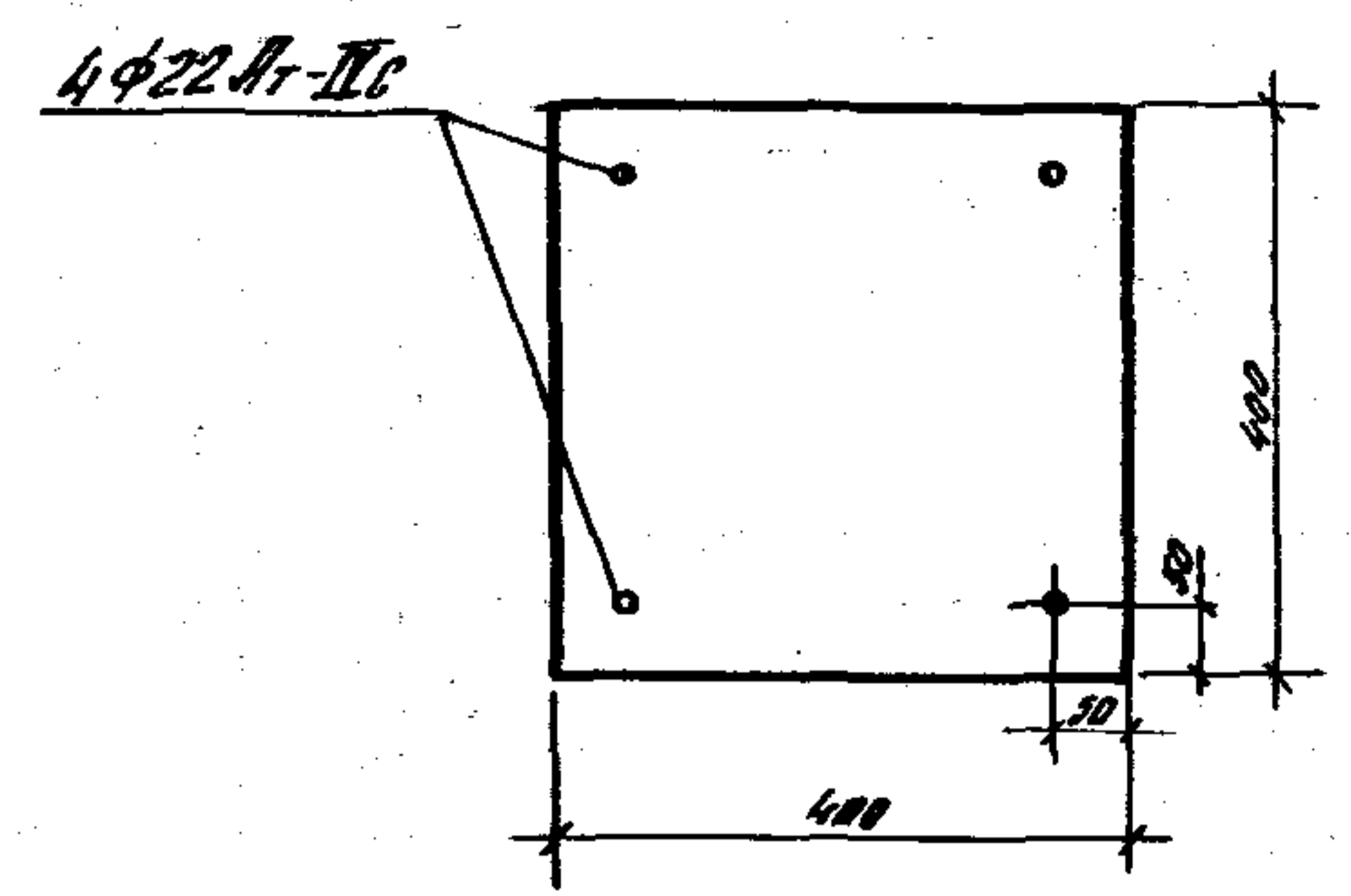
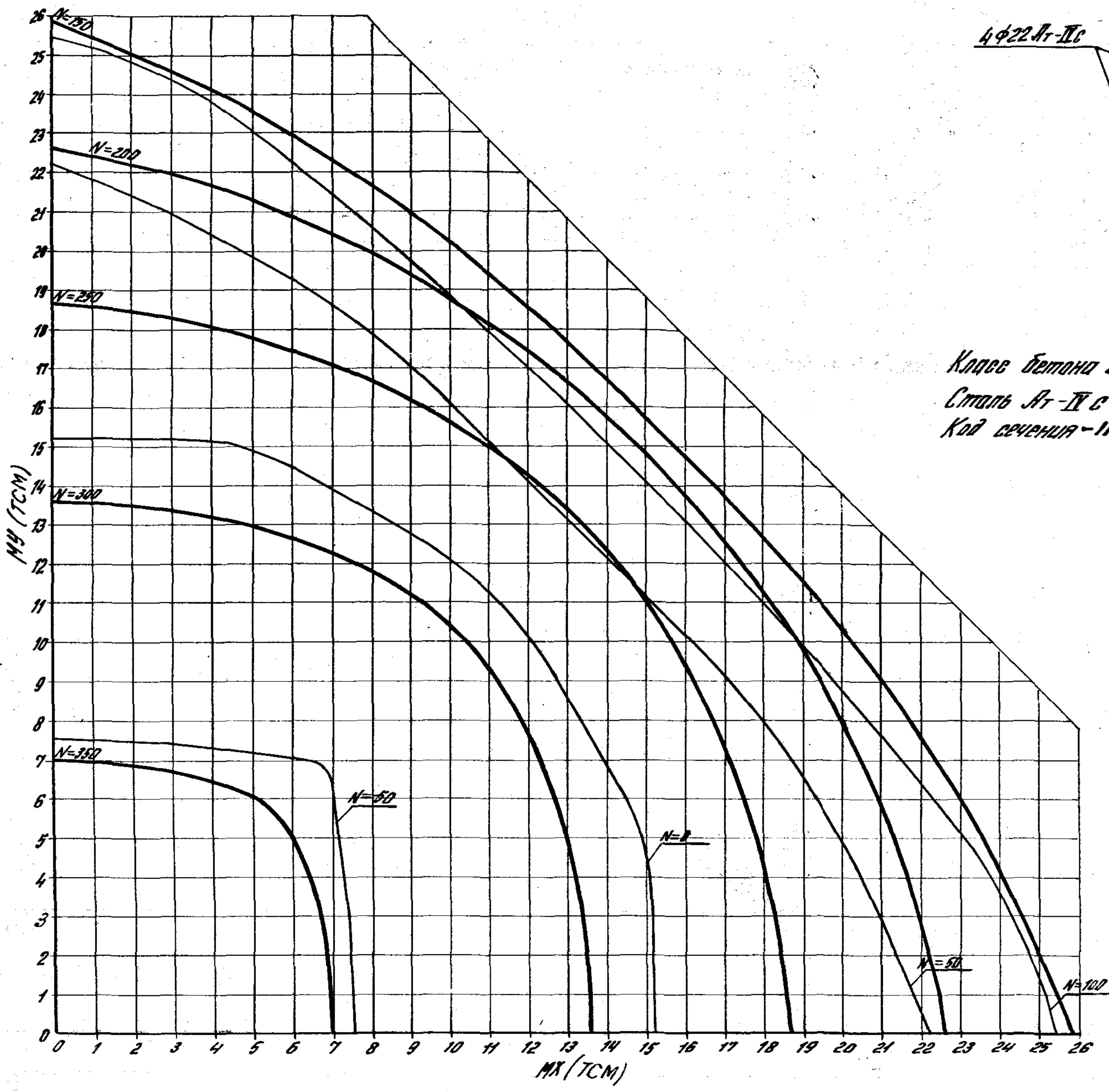

Класс бетона В40,0 ($R_b = 19.8$ МПа при учете $\gamma_{b2} = 0.90$)
 Сталь А-III с
 Код сечения - 1128

Имя, И. год. Проект и дата
 Взам. инв. №

1.020.1-4 0-9 002
 93

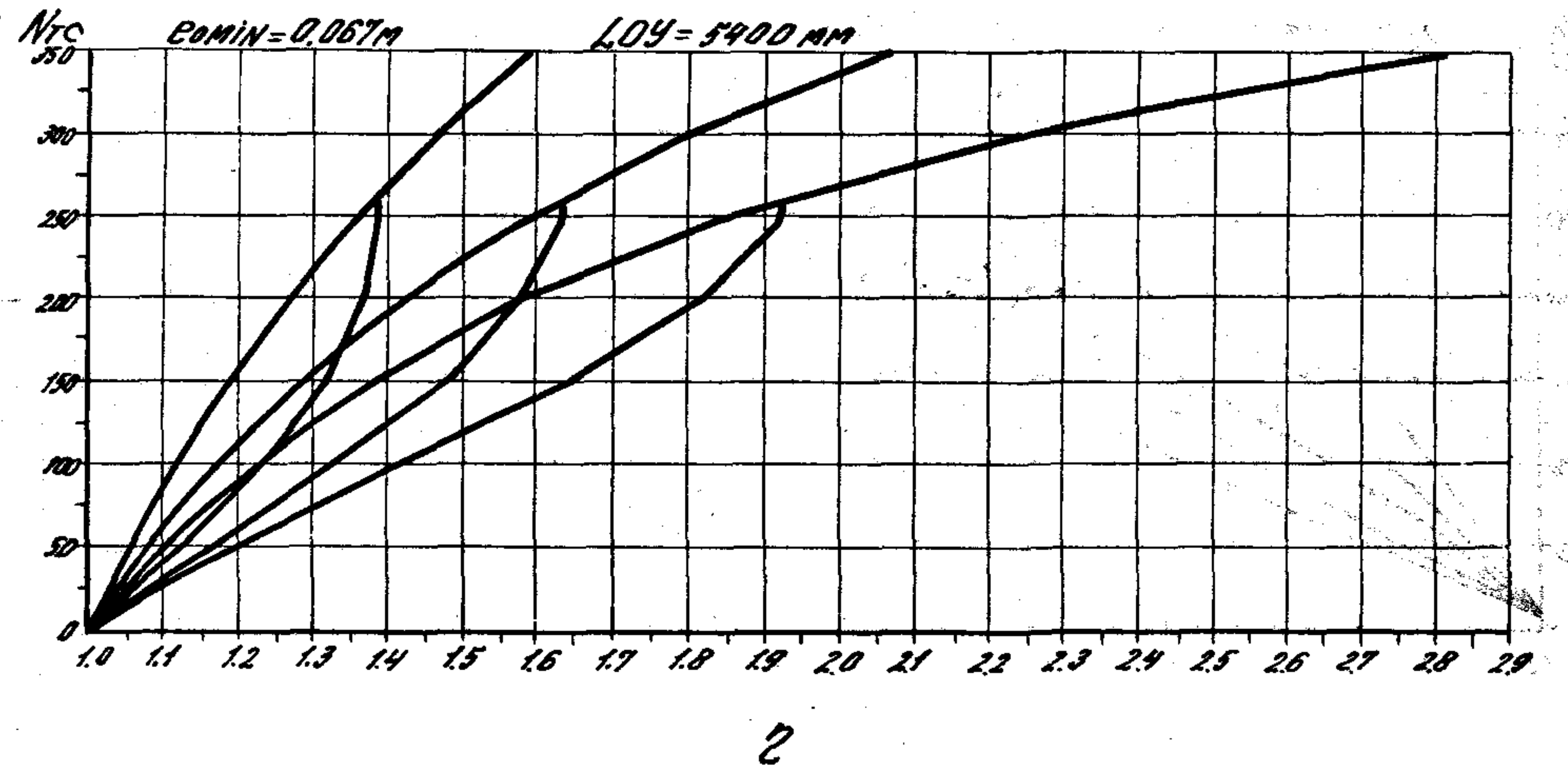
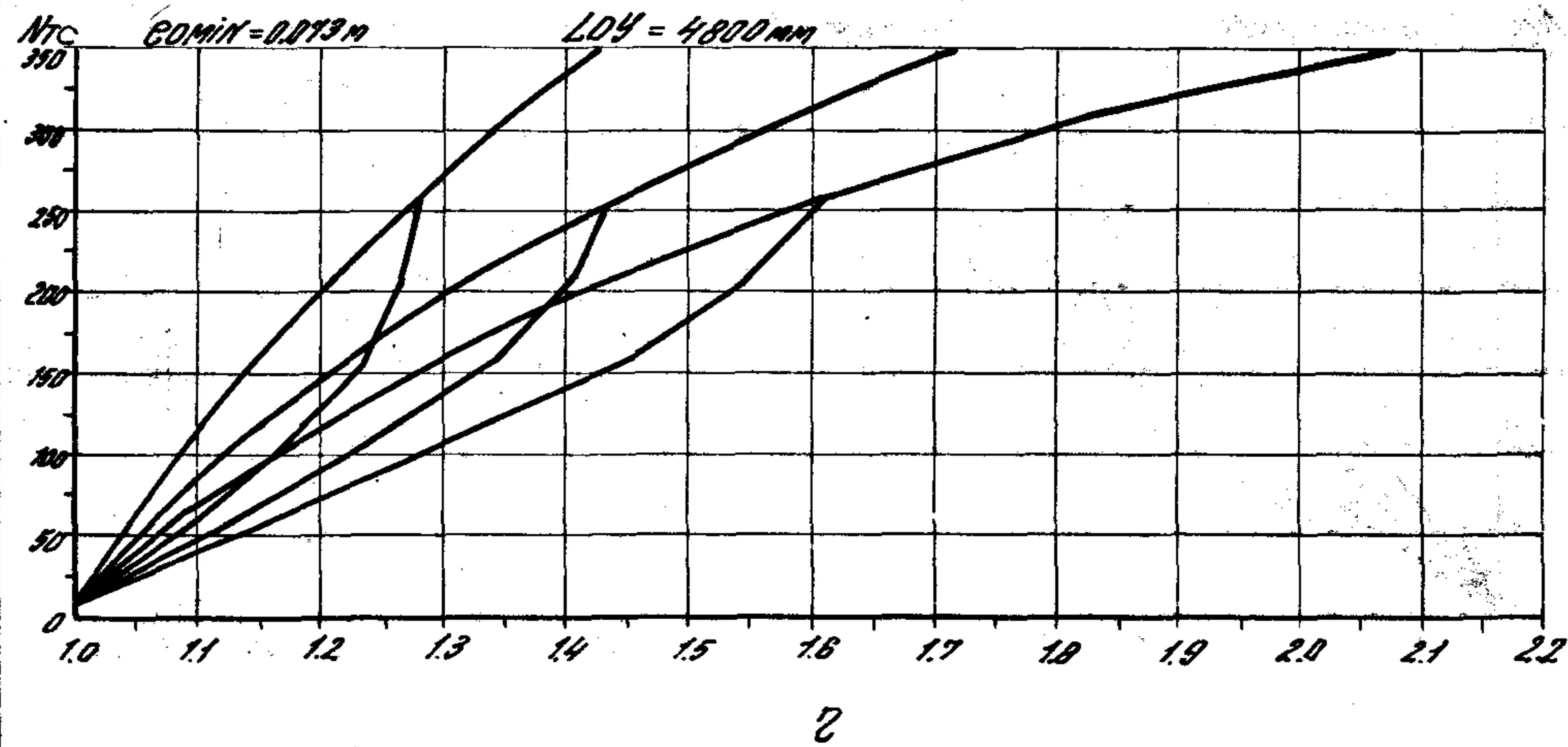
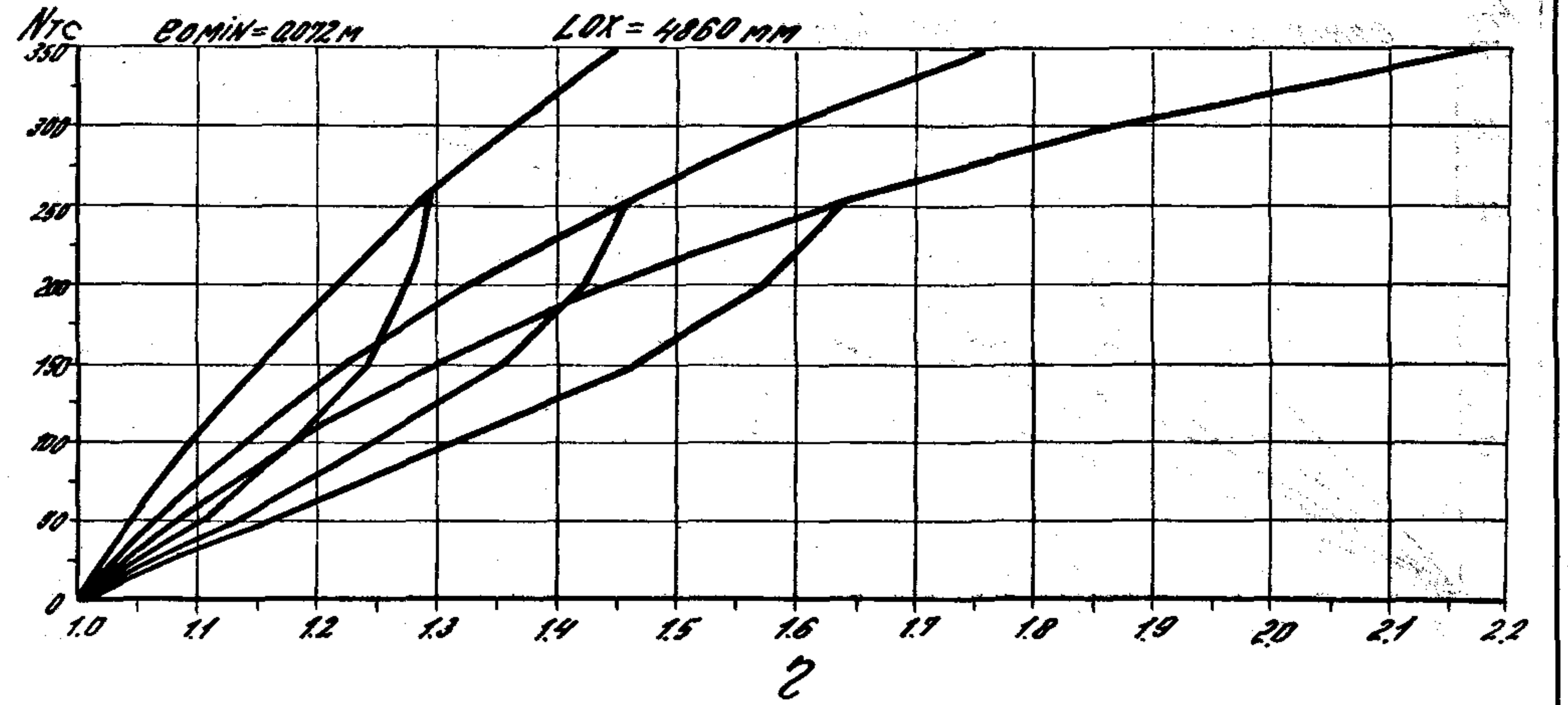
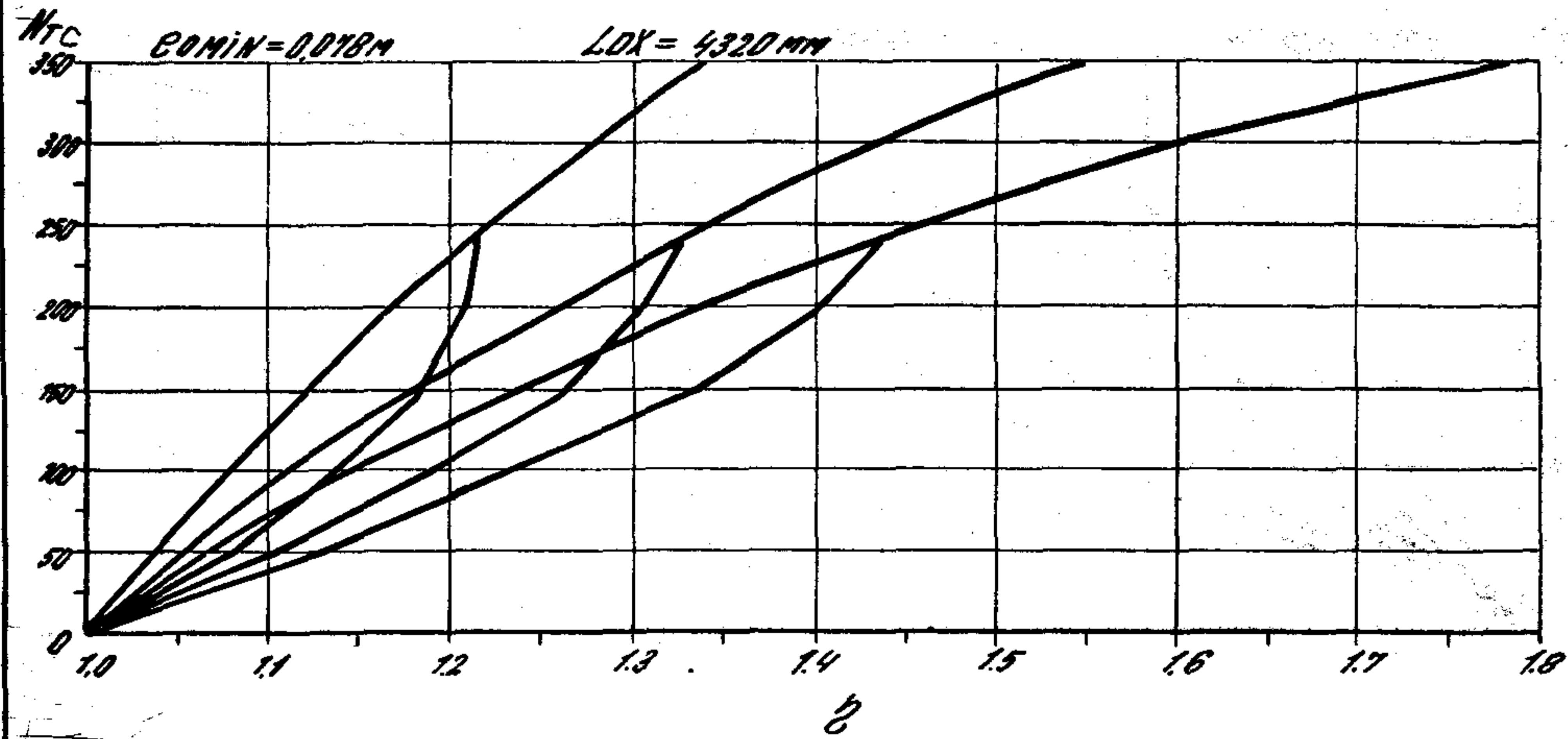

1.020.1-4
 0-9 002
 95

1.020.1-4 0-9 002 AUCT
95

QUILA

